

COMPACT PRICE LIST

Valid from 06/2024





At HSK, you get more than just a glass splashback. State-of-the-art and tested production technology allows us to customise the products to your individual requirements: made to measure, fast and flexible. Complete your bathroom furnishings with coordinated products from HSK such as shower cubicles, shower trays, fittings, wall cladding and designer radiators – all from a single source.

As a strong company in the region, we are proud of our qualified team, because people make the difference for us. Long-standing and experienced employees work on products with high functionality and quality at an excellent price. A high level of motivation and personal commitment in sales, technology and production ensure outstanding service and satisfied customers.

The topic of sustainability is also very important to us and is promoted and practised under the slogan "HSK Goes Green". We are constantly working on optimising materials, packaging, transport routes and work processes. The fact that our efforts have been recognised and that we were awarded 1st place as a TOP BRAND in the "Environment and Sustainability" category under the heading "Shower enclosures" confirms and motivates us to do even more for sustainability.



Yours

Joachim Schulte-Lohgerber

Joachim Schulte-Lohgerber
Managing Shareholder of HSK Duschkabinenbau KG

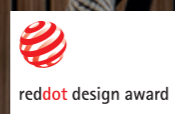

The Hochsauerlandkreis is the home of HSK. Like many other traditional companies, we feel very much at home in our location, because our heart beats for the Sauerland region. As a family business with a long tradition, we have developed from here over many years into an internationally active company and a strong partner to the sanitary trade. We produce shower solutions and provide the necessary warmth in the bathroom.



HSK DUSCHKABINENBAU KG
Bathroom Experts

OLSBERG (City)
Hochsauerlandkreis, NRW

CONCEPT, PRICE
AND QUALITY
IS OUR
PROMISE

www.hsk.de/en/gb

Product variety

WALK IN	08
FRAMELESS & PARTIALLY FRAMED SHOWER CUBICLES	20
Pure + Pure Pro	20
K2 ^P	30
Atelier Plan	38
Aperto	46
Premium Softcube	54
Exklusiv 2.0	62
Regency	76
Solida	80
FRAMED SHOWER CUBICLES	86
Favorit Plus	86
MADE TO MEASURE	94
SHOWER TRAYS	98
BATH SCREENS	106
SHOWER & CO	112
SHOWER ACCESSORIES	122
DESIGNER RADIATORS	126
RENODECO WALL CLADDING	142

Complement
your bathroom
furnishings with
coordinated
products from
HSK



SHOWER CUBICLES



SHOWER TRAYS



BATH SCREENS



SHOWER & CO



SHOWER ACCESSORIES



DESIGNER RADIATORS



RENODECO



Low maintenance
Crystal clear
aesthetic
Environmentally friendly

Double protection with TwinSeal

Step 1: Using a specific magnetron technology, the open-pore, raw glass is sealed with a high-resistance corrosion protection layer. This ultra-thin, colour-neutral coating prevents limestone sticking and the glass becoming dull (corrosion).

Step 2: A hydrophobic nanolayer is applied giving the glass a special characteristic which is comparable to the drip-off effect of a lotus flower. When sitting on the TwinSeal layer, the water contracts so that it will drip off more readily.

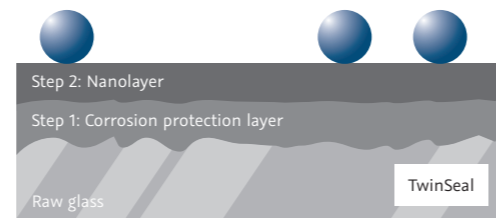

Limestone and grime don't stick to the glass.



Limestone and grime coalesce with the glass. The glass is soiled.

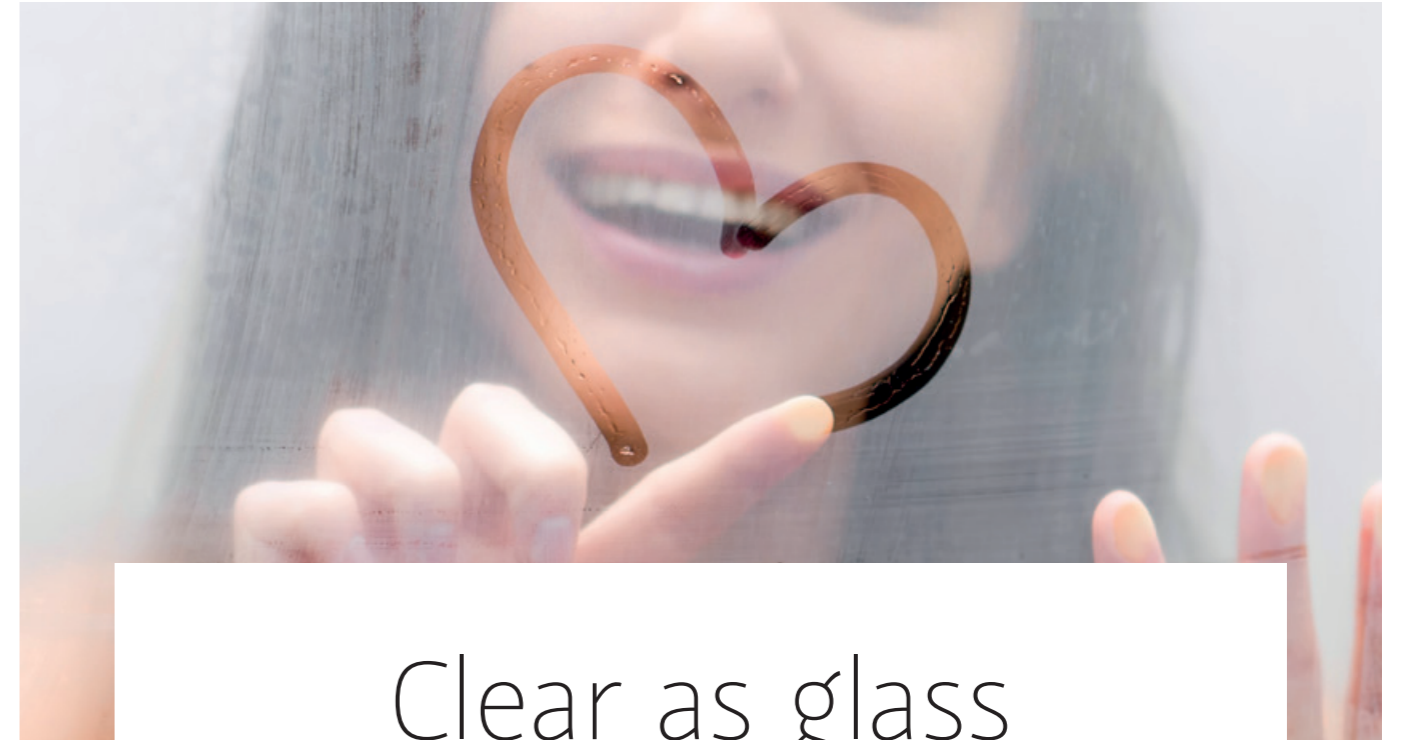

Clear as glass

TWINSEAL GLASS SEALING

The groundbreaking technique allows for the double-coating of the glass surface of shower cubicles, thus providing twice as much brilliance. With the **TwinSeal** glass sealant, we have created a one-of-a-kind surface protection system that delivers a maximum of corrosion resistance together with convincing hydrophobic characteristics. This combination endows the inside of the glass with a double protection, thus ensuring superlative transparency. There is no more need for the cubicle to be cleaned after every shower. Just remove any deposits once a week with a microfibre cloth.



The benefits

- + 10 years guarantee
- + High corrosion resistance
- + Hydrophobic characteristics
- + Keeps limestone and grime off
- + Easy to clean
- + Improved hygiene

Environmentally friendly

Minimised use of cleaners means that **TwinSeal** glass is particularly eco-friendly, which we are happy to support.

WALK IN



Experience new freedom

WALK IN

Open room and shower concepts
in a modern design with
practical functions and a wide
range of options.

www.hsk.de/en/gb



Walk In Pro front panel. Pic. shows glass option Ground fog glass (176).
Shower-set see page 118. RenoDeco wall cladding see page 142 – 159.

WALK IN | Experience new freedom

WALK IN

Limitless

In addition to limitless showering pleasure, the free-standing Walk In solutions offer airy architecture with plenty of room for creativity. Step into a world of new dimensions. The optional frosted glass provides discreet privacy and a timeless decor.





WALK IN

Pic. shows glass option Ground fog glass (176).

Mounting on tile

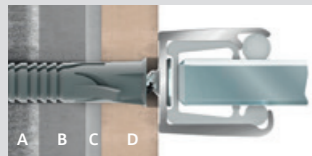

A) Wall B) Plaster C) Tile adhesive D) Wall tile

Mounting on plaster



Plastering rail

Mounting in plaster

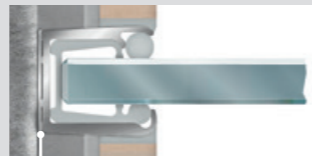

Plastering rail



WALK IN PRO

Front panel

8 mm Toughened safety glass (ESG)

Version cm	Element dimensions cm (Height 200)	Article no.	Chrome finish, stainless steel finish	Black matt, white matt	Brushed gunmetal/ gold / copper
Standard size			Toughened safety glass, clear glass (50)		
70	69 – 70	1733070	519,-	519,-	641,-
75	74 – 75	1733075	519,-	519,-	641,-
80	79 – 80	1733080	519,-	519,-	641,-
90	89 – 90	1733090	519,-	519,-	641,-
100	99 – 100	1733100	531,-	531,-	652,-
110	109 – 110	1733110	553,-	553,-	675,-
120	119 – 120	1733120	553,-	553,-	675,-
140	139 – 140	1733140	569,-	569,-	691,-
Made to measure			Height to 220		
			1733500	587,-	587,- 708,-



Profile colours Walk In Pro

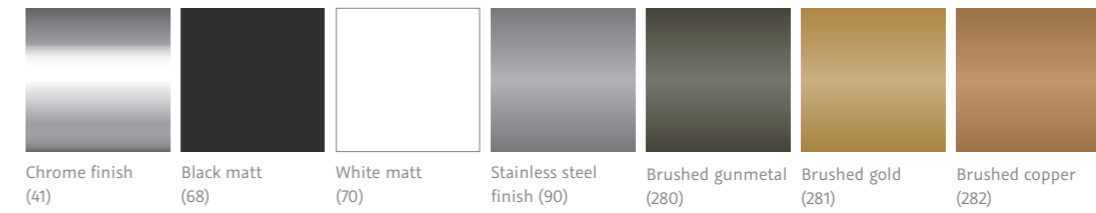

Glass options Walk In Pro, 8 mm Toughened safety glass (ESG)



GLASS OPTIONS

- Toughened safety glass, clear glass**
incl. HSK Shield
- TwinSeal**
+ 186,-
- Smoked glass**
+ 92,-
- Sandblasted**
+ 124,-
- Linea / Loft**
+ 208,-



WALK IN REGENCY



Sliding door, 2 parts
8 / 6 mm Toughened safety glass (ESG)

Version cm	Element dimensions cm (Height 200)	Article no.	Chrome finish	Black matt	Matt gold
Standard size					
120	113,3 – 115,3	635120	857,-	1.098,-	1.098,-
140	133,3 – 135,3	635140	944,-	1.185,-	1.185,-
Made to measure					
		635500	1.293,-	1.534,-	1.534,-

Please indicate position of the front fixed panel.

GLASS OPTIONS

- Toughened safety glass, clear glass**
 - incl. HSK Shield
 - incl. HSK Shield
- TwinSeal**
 - + 186,-
 - + 372,-
- Smoked glass**
 - + 92,-
 - + 184,-
- Sandblasted**
 - + 124,-
 - + 248,-



WALK IN K2^P



Sliding door, 2 parts
8 mm Toughened safety glass (ESG) with clip profile

Version cm	Element dimensions cm (Height 200)	Article no.	Chrome finish	
Standard size				
120	116,8 – 118,8	2135120	1.173,-	
140	136,8 – 138,8	2135140	1.231,-	
160	156,8 – 158,8	2135160	1.291,-	
Made to measure				
	to 115 – 180 × 220	2135500	1.467,-	

Please indicate position of the front fixed panel.



WALK IN ATELIER PLAN



Sliding door, 2 parts
8 mm Toughened safety glass (ESG) technical profile with softclose

Version cm	Element dimensions cm (Height 206)	Article no.	Chrome finish	Black matt
Standard size				
100	96,5 – 98,5	17308100	1.350,-	1.350,-
120	116,5 – 118,5	17308120	1.408,-	1.408,-
140	136,5 – 138,5	17308140	1.466,-	1.466,-
160	156,5 – 158,5	17308160	1.525,-	1.525,-
Made to measure				
	to 140 × 206	17308500	1.584,-	1.584,-
	to 200 × 206	17308500	1.692,-	1.692,-

Please indicate position of the front fixed panel.

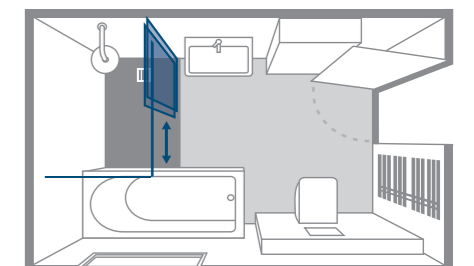
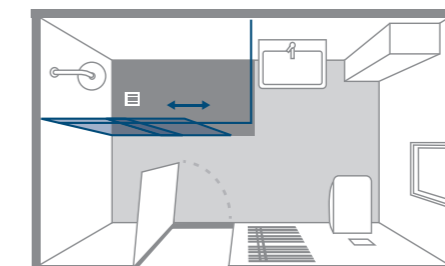
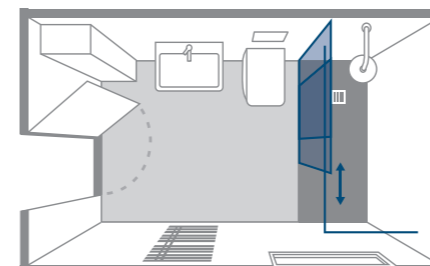



Walk In Exklusiv 2.0 bi-fold door swinging with inline panel

This Walk In bi-fold door offers a classic yet timeless solution for the whole family. It is ideal for small spaces or airy room concepts. The door element can be completely folded inwards or swivelled around the fitting. The glass-flush hinges on the inside and innovative profiles make cleaning the shower cubicles beautifully easy. The black matt colour rounds off the bathroom design and creates a modern look.

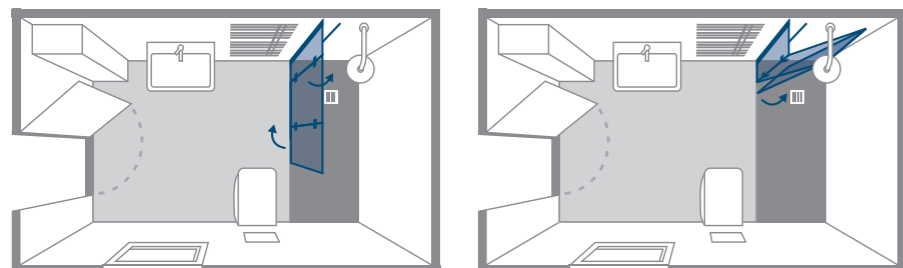

GLASS OPTIONS

Toughened safety glass, clear glass

- incl. HSK Shield
- incl. HSK Shield

TwinSeal

- + 186,-
- + 372,-

Smoked glass

- + 92,-
- + 184,-

Sandblasted

- + 124,-
- + 248,-



WALK IN EXKLUSIV 2.0 SWINGING

Bi-fold door swinging

6 mm Toughened safety glass (ESG)

with hinges flush with the glass on the inside and buffer handle

Version cm	Element dimensions cm (Height 200)	D1 cm	D2 cm	Article no.	Aluminium silver matt	Chrome finish	Black matt
				Toughened safety glass, clear glass (50)			
Standard size							
90	88 – 90	37,3	50,3	48206090	734,-	833,-	833,-
100	98 – 100	42,3	55,3	48206100	773,-	864,-	864,-
120	118 – 120	52,3	65,3	48206120	806,-	912,-	912,-
140	138 – 140	62,3	75,3	48206140	846,-	951,-	951,-

Made to measure

to 50 – 140 × 210	48206500	899,-	999,-	999,-
-------------------	-----------------	-------	-------	-------

D1 = Front door element, D2 = Rear door element. Please indicate hinged side of the door. The hinge type Softcube, on the inside of the glass surface, is supplied as standard. Classic hinge shape is optionally available. Please indicate desired hinge shape.



WALK IN EXKLUSIV 2.0 SWINGING

Bi-fold door swinging with inline panel

6 mm Toughened safety glass (ESG)

with hinges flush with the glass on the inside, keder profile for side panel and buffer handle

Version cm	Element dimensions cm (Height 200)	D1 cm	D2 cm	Article no.	Aluminium silver matt	Chrome finish	Black matt
				Toughened safety glass, clear glass (50)			
Standard size							
90	87,5 – 90	28,9	34,7	48207090	773,-	880,-	880,-
100	97,5 – 100	32,3	41,3	48207100	817,-	912,-	912,-
120	117,5 – 120	42,3	51,3	48207120	846,-	958,-	958,-
140	137,5 – 140	52,3	61,3	48207140	880,-	999,-	999,-

Made to measure

to 50 – 140 × 210	48207500	938,-	1.055,-	1.055,-
-------------------	-----------------	-------	---------	---------

D1 = Front door element, D2 = Rear door element. Please indicate hinged side of the door. The hinge type Softcube, on the inside of the glass surface, is supplied as standard. Classic hinge shape is optionally available. Please indicate desired hinge shape.



Also available in black matt

Walk In Aperto bi-fold door swinging with inline panel

The Walk In Aperto is particularly suitable for open-plan room and shower concepts. Thanks to the narrow fixed element, the door can simply be folded and swivelled away without touching the fitting. This creates a lot of extra space.

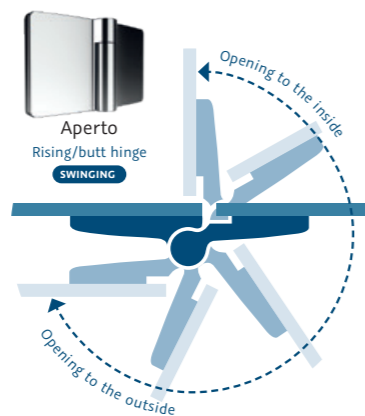

GLASS OPTIONS

- Toughened safety glass, clear glass**
 - incl. HSK Shield
 - incl. HSK Shield
- TwinSeal**
 - + 186,-
 - + 372,-
- Smoked glass**
 - + 92,-
 - + 184,-
- Sandblasted**
 - + 124,-
 - + 248,-



WALK IN APERTO SWINGING

Pivot door swinging with inline panel

8/6 mm Toughened safety glass (ESG)

with hinges flush with the glass on the inside, clip profile and buffer handle

Version cm	Element dimensions cm (Height 200)	Inline panel cm (Height 200)	Article no.	Chrome finish	Black matt
			Toughened safety glass, clear glass (50)		
Standard size					
90	88,5 – 90,5	30,5 – 32,5	2826090	817,-	817,-
100	98,5 – 100,5	30,5 – 32,5	2826100	916,-	916,-
120	118,5 – 120,5	40,5 – 42,5	2826120	951,-	951,-
Made to measure					
				to 130 × 220	2826500 1.016,- 1.016,-
				to 180 × 220	2826500 1.168,- 1.168,-

Please indicate hinged side of the door.



WALK IN APERTO SWINGING

Bi-fold door swinging with inline panel

8/6 mm Toughened safety glass (ESG)

with hinges flush with the glass on the inside, clip profile and buffer handle

Version cm	Element dimensions cm (Height 200)	Inline panel cm (Height 200)	Article no.	Chrome finish	Black matt
			Toughened safety glass, clear glass (50)		
Standard size					
100	98,5 – 100,5	25	2827100	968,-	968,-
120	118,5 – 120,5	30	2827120	999,-	999,-
140	138,5 – 140,5	40	2827140	1.027,-	1.027,-
160	158,5 – 160,5	60	2827160	1.055,-	1.055,-
Made to measure					
				to 130 × 210	2827500 1.121,- 1.121,-
				to 180 × 210	2827500 1.218,- 1.218,-

Please indicate hinged side of the door.



The concept

PURE + PURE PRO

A minimalist design concept that optimally combines functionality and design.



PURE + PURE PRO | The concept

PURE + PURE PRO

Endlessly combinable

Pure – minimalist to a maximum, where you need experts for taking measure and installing as there is no adjustment possibility, whereas we offer adjustment with the very slim profile of the Pure Pro.

Tailored to your taste and your bathroom situation, you can combine the profile colour, the glass design and the product finish in many different ways. The Pure range is fitted with pivoting hinges that are flush with the glass on the inside and is supplied in a standard height of 200 cm.



Chrome finish (41)



Black matt (68)



White matt (70)



Stainless steel finish (90)



Brushed gunmetal (280)

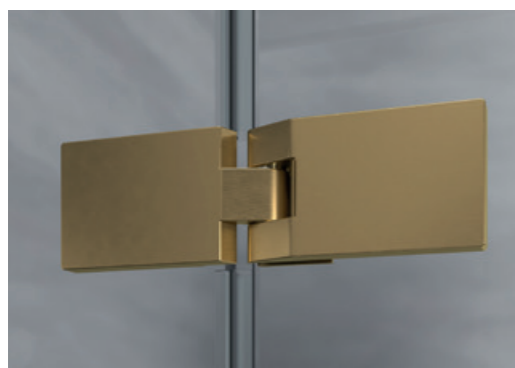

Brushed gold (281)



Brushed copper (282)



Pure hinged door with inline panel and side panel



PURE P.01 SWINGING

Hinged door swinging for recess
8 mm Toughened safety glass (ESG)



Width x height cm	Article no.	Chrome finish, stainless steel finish	Black matt, white matt	Brushed gunmetal/ gold/ copper
Made to measure from 30 – 100 x 165 – 200	Toughened safety glass, clear glass (50) P.01	823,-	823,-	1.064,-
Special height (up to 220 cm)				+ 145,-
Cut-out or slope > 20 mm				+ 170,-
Drip profile (floor only chrome finish / black matt / white matt)				+ 48,-

Please indicate hinged side of the door.

GLASS OPTIONS

Toughened safety glass, clear glass

- incl. HSK Shield
- incl. HSK Shield

TwinSeal

- + 243,-
- + 486,-

Smoked glass

- + 145,-
- + 290,-

Sandblasted

- + 145,-
- + 290,-



PURE P.04 SWINGING

Hinged door swinging with inline panel for recess
8 mm Toughened safety glass (ESG)



Width x height cm	Article no.	Chrome finish, stainless steel finish	Black matt, white matt	Brushed gunmetal/ gold/ copper
Made to measure from 60 – 120 x 165 – 200	Toughened safety glass, clear glass (50) P.04	1.057,-	1.057,-	1.538,-
Special width (up to 160 cm)				+ 206,-
Special height (up to 220 cm)				+ 145,-
Cut-out or slope > 20 mm				+ 170,-
Drip profile (floor only chrome finish / black matt / white matt)				+ 48,-

Please indicate hinged side of the door.



PURE P.05 SWINGING

Saloon door
8 mm Toughened safety glass (ESG)



Width x height cm	Article no.	Chrome finish, stainless steel finish	Black matt, white matt	Brushed gunmetal/ gold/ copper
Made to measure from 60 – 120 x 165 – 200	Toughened safety glass, clear glass (50) P.05	1.431,-	1.431,-	1.912,-
Special width (up to 160 cm)				+ 206,-
Special height (up to 220 cm)				+ 145,-
Drip profile (floor only chrome finish / black matt / white matt)				+ 48,-

Glass options Pure, 8 mm Toughened safety glass (ESG)



Handles

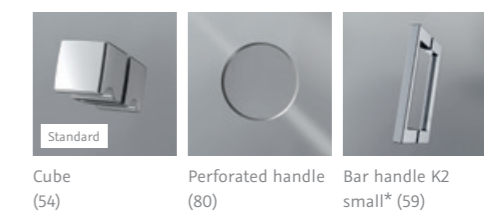

* Only available in chrome, black matt, stainless steel finish and brushed gunmetal.



PURE P.23 SWINGING

Hinged door swinging with inline panel and side panel
8 mm Toughened safety glass (ESG)

Width x height cm		Article no.	Chrome finish, stainless steel finish	Black matt, white matt	Brushed gunmetal/ gold/ copper
Made to measure		Toughened safety glass, clear glass (50) P.23	1.674,-	1.674,-	2.395,-
Hinged door	from 60 – 120				
Side panel	from 30 – 120 x 165 – 200				

Special width hinged door and side wall (up to 160 cm)	+ 206,-
Special height (up to 220 cm)	+ 145,-
Cut-out or slope > 20 mm	+ 170,-
Drip profile (floor only chrome finish / black matt / white matt)	+ 48,-

Please indicate hinged side of the door.

GLASS OPTIONS

- Toughened safety glass, clear glass**
 - incl. HSK Shield
 - incl. HSK Shield
- TwinSeal**
 - + 243,-
 - + 486,-
- Smoked glass**
 - + 145,-
 - + 290,-
- Sandblasted**
 - + 145,-
 - + 290,-



PURE P.20 SWINGING

Hinged door swinging with side panel
8 mm Toughened safety glass (ESG)

Width x height cm		Article no.	Chrome finish, stainless steel finish	Black matt, white matt	Brushed gunmetal/ gold/ copper
Made to measure		Toughened safety glass, clear glass (50) P.20	1.445,-	1.445,-	1.926,-
Hinged door	from 30 – 100				
Side panel	from 30 – 120 x 165 – 200				

Special width side panel (up to 160 cm)	+ 206,-
Special height (up to 220 cm)	+ 145,-
Cut-out or slope > 20 mm	+ 170,-
Drip profile (floor only chrome finish / black matt / white matt)	+ 48,-

Please indicate hinged side of the door.



PURE P.79

Walk In
8 mm Toughened safety glass (ESG)

Width x height cm		Article no.	Chrome finish, stainless steel finish	Black matt, white matt	Brushed gunmetal/ gold/ copper
Made to measure		Toughened safety glass, clear glass (50) P.79	629,-	629,-	869,-
from 30 – 120 x 165 – 200					

Special width (up to 160 cm)	+ 206,-
Special height (up to 220 cm)	+ 145,-
Cut-out or slope > 20 mm	+ 170,-

PURE + PURE PRO | The concept

PURE + PURE PRO



PURE PRO SWINGING

Hinged door swinging with inline panel and side panel
8 mm Toughened safety glass (ESG)



Version cm	Element dimensions cm (Height 200)	Article no.	Chrome finish, stainless steel finish	Black matt, white matt	Brushed gunmetal/ gold/ copper
Standard size hinged door					
90	86,6 – 87,6	2660090	1.008,-	1.008,-	1.489,-
100	96,6 – 97,6	2660100	1.057,-	1.057,-	1.538,-
120	116,6 – 117,6	2660120	1.105,-	1.105,-	1.586,-
Standard size side panel					
90	86,6 – 87,6	2663090	727,-	727,-	848,-
100	96,6 – 97,6	2663100	751,-	751,-	872,-
Made to measure					
Hinged door	from 60 – 120 × 165 – 200	2660500	1.178,-	1.178,-	1.659,-
Side panel	from 30 – 120 × 165 – 200	2663500	824,-	824,-	945,-

Please indicate hinged side of the door.



GLASS OPTIONS



Toughened safety glass, clear glass

-  incl. HSK Shield
-  incl. HSK Shield

TwinSeal

-  + 243,-
-  + 486,-

Smoked glass

-  + 145,-
-  + 290,-

Sandblasted

-  + 145,-
-  + 290,-



PURE PRO SWINGING

Hinged door swinging with inline panel for recess
8 mm Toughened safety glass (ESG)



Version cm	Element dimensions cm (Height 200)	Article no.	Chrome finish, stainless steel finish	Black matt, white matt	Brushed gunmetal/ gold/ copper
Standard size					
		Toughened safety glass, clear glass (50)			
90	87,5 – 88,5	2661090	1.008,-	1.008,-	1.489,-
100	97,5 – 98,5	2661100	1.057,-	1.057,-	1.538,-
120	117,5 – 118,5	2661120	1.105,-	1.105,-	1.586,-
Made to measure					
from 60 – 120 × 165 – 200		2661500	1.178,-	1.178,-	1.659,-

Please indicate hinged side of the door.

Options

- Special width side panel (up to 160 cm)
- Special height (up to 220 cm)
- Cut-out or slope > 20 mm
- Drip profile (floor only chrome finish / black matt / white matt)

- + 206,-
- + 145,-
- + 170,-
- + 48,-

Tightness and splash water protection

Completely dispensing with wall and floor profiles cannot achieve absolute impermeability. However, transparent seals significantly prevent splash water from escaping. Optionally available water mouldings additionally reinforce the splash protection.

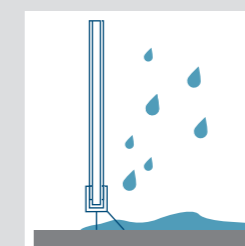

Without a water bar, splash water may escape

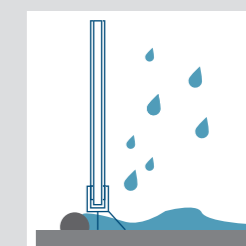

The optional water moulding provides increased impact protection



Straightforward design with high standards

K2^P

These shower cubicles bring elegance to the bathroom. Elegant aluminium profiles ensure easy installation of the high-quality glass.



K2^P | Straightforward design with high standards



A good combination

Advantages of both worlds: The high quality hinge from the K2 series is combined with a clip profile. This means that the K2^P can cope perfectly with uneven walls and enables easy installation.



Easy to clean

The K2^P hinges are flush with the glass on the inside and therefore easy to clean. This results in fewer deposits and makes it much easier to clean the glass elements.



Beautifully shaped

Shower cubicles thrive on high-quality materials and functional details. This means that the handles on the wide range of hinged, sliding, swing and bi-folding doors are also a special feature. HSK offers a wide range of handle solutions for convenient handling and timeless design.

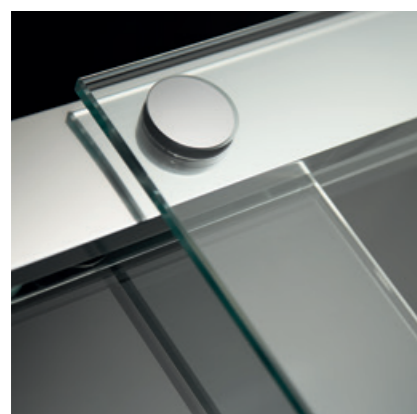

Smooth

The doors in the K2^P series glide smoothly and quietly along a closed track. The design has already won two awards.



K2^P | Straightforward design with high standards



K2^P SWINGING

Corner entry swinging, 4 parts
8 mm Toughened safety glass (ESG)
with hinges flush with the glass on the inside and clip profile

Version cm	Shower tray installation dimensions cm (Height 200)	Tile dimensions in cm	Article no.	Chrome finish
Standard size				
75 × 90	78,5 – 80,5	75,9 – 77,9	Toughened safety glass, clear glass (50)	
80 × 80			2125012	1.996,-
80 × 90			2125014	1.950,-
90 × 75			2125015	1.996,-
90 × 80			2125016	1.996,-
90 × 90	88,5 – 90,5	85,9 – 87,9	2125018	2.032,-
100 × 100	98,5 – 100,5	95,9 – 97,9	2125019	2.113,-
Made to measure				
to 130 × 220			2125500	2.208,-

GLASS OPTIONS

- Toughened safety glass, clear glass**
- incl. HSK Shield
- incl. HSK Shield
- TwinSeal**
- + 186,-
- + 372,-
- Smoked glass**
- + 92,-
- + 184,-
- Sandblasted**
- + 124,-
- + 248,-

K2^P SWINGING

Hinged door swinging with inline panel for recess
8 mm Toughened safety glass (ESG)
with hinges flush with the glass on the inside and clip profile

Version cm	Recess dimensions cm (Height 200)	Article no.	Chrome finish
Standard size			
75	72 – 75	2105075	1.092,-
80	77 – 80	2105080	1.092,-
90	87 – 90	2105090	1.128,-
100	97 – 100	2105100	1.173,-
120	117 – 120	2105120	1.231,-
Made to measure			
to 180 × 220		2105500	1.339,-

Please indicate hinged side of the door.

GLASS OPTIONS

- Toughened safety glass, clear glass**
- incl. HSK Shield
- incl. HSK Shield
- TwinSeal**
- + 186,-
- + 372,-
- Smoked glass**
- + 92,-
- + 184,-
- Sandblasted**
- + 124,-
- + 248,-

K2^P | Straightforward design with high standards



K2^P



Recess slider, 2 parts

8 mm Toughened safety glass (ESG) with clip profile

Version cm	Recess dimensions cm (Height 200)	Article no.	Chrome finish
Standard size			
120	118,5 – 120,5	2122120	1.173,-
140	138,5 – 140,5	2122140	1.231,-
160	158,5 – 160,5	2122160	1.291,-
Made to measure			
	to 200 × 220	2122500	1.467,-

Please indicate position of the front fixed panel.

GLASS OPTIONS

- Toughened safety glass, clear glass**
 - incl. HSK Shield
 - incl. HSK Shield
- TwinSeal**
 - + 186,-
 - + 372,-
- Smoked glass**
 - + 92,-
 - + 184,-
- Sandblasted**
 - + 124,-
 - + 248,-

K2^P



Slider, 2 parts with side panel

8 mm Toughened safety glass (ESG) with clip profile

Version cm	Shower tray installation dimensions cm (Height 200)	Tile dimensions in cm	Article no.	Chrome finish
Standard size				
120 × 90	118,5 – 120,5	115,3 – 117,3 × 85,3 – 87,3	2140120	1.822,-
140 × 90	138,5 – 140,5	135,3 – 137,3 × 85,3 – 87,3	2140140	1.878,-
160 × 90	158,5 – 160,5	155,3 – 157,3 × 85,3 – 87,3	2140160	1.938,-
Made to measure				
Front element	to 200 × 220		2140500	2.114,-
Side panel	to 130 × 220			

Please indicate position of the side panel

GLASS OPTIONS

- Toughened safety glass, clear glass**
 - incl. HSK Shield
 - incl. HSK Shield
- TwinSeal**
 - + 186,-
 - + 372,-
- Smoked glass**
 - + 92,-
 - + 184,-
- Sandblasted**
 - + 124,-
 - + 248,-

Modern lightness with profile

ATELIER PLAN

Clear lines combined with
8 mm thick glass elements
create a light look.



ATELIER PLAN | Modern lightness with profile

ATELIER PLAN



Straightforward

The Atelier Plan hinge, which is flush with the glass on the inside, impresses with its clear yet light design language. The standard rising/butt mechanism makes handling more convenient.

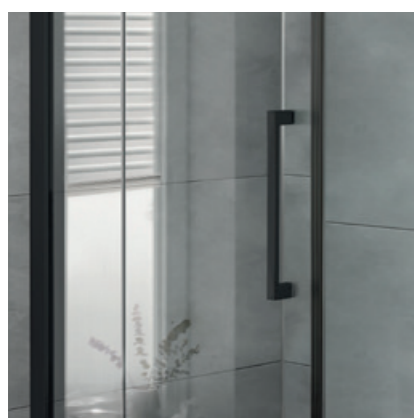

Striking

The handles in the Atelier Plan series are visual eye-catchers on the shower door and combine slimline design with convenient handling.



Reliable

A magnetic closing bar in combination with the ergonomic handles ensures that the 8 mm doors close cleanly and reliably.



Swinging

The Atelier Plan profiles of the bi-fold door solutions have chrome-plated pivot bearings with a swing function. The integrated rising/butt mechanism ensures easy opening and closing.



Our hinged products Atelier Plan are also available without profiles for a minimalistic look. Please contact our office.

ATELIER PLAN | Modern lightness with profile



ATELIER PLAN

ATELIER PLAN



Recess slider, 2 parts

8 mm Toughened safety glass (ESG) with technical profile with softclose

Version cm	Recess dimensions cm (Height 200)	Article no.	Chrome finish	Black matt
Standard size				
100	98,5 – 100,5	17228100	1.350,-	1.350,-
120	118,5 – 120,5	17228120	1.408,-	1.408,-
140	138,5 – 140,5	17228140	1.466,-	1.466,-
160	158,5 – 160,5	17228160	1.525,-	1.525,-
Made to measure				
	to 140 × 220	17228500	1.584,-	1.584,-
	to 200 × 220	17228500	1.692,-	1.692,-

Please indicate position of the front fixed panel.

GLASS OPTIONS

Toughened safety glass, clear glass

- incl. HSK Shield
- incl. HSK Shield

TwinSeal

- + 186,-
- + 372,-

Smoked glass

- + 92,-
- + 184,-

Sandblasted

- + 124,-
- + 248,-



ATELIER PLAN



Slider, 2 parts with side panel

8 mm Toughened safety glass (ESG) with technical profile with softclose

Version cm	Shower tray installation dimensions cm (Height 206)	Tile dimensions cm	Article no.	Chrome finish	Black matt
Standard size					
100 / 90	98,5 – 100,5 / 88,5 – 90,5	95,6 – 97,6 / 85,6 – 87,6	17408100	1.996,-	1.996,-
120 / 90	118,5 – 120,5 / 88,5 – 90,5	115,6 – 117,6 / 85,6 – 87,6	17408120	2.054,-	2.054,-
140 / 90	138,5 – 140,5 / 88,5 – 90,5	135,6 – 137,6 / 85,6 – 87,6	17408140	2.113,-	2.113,-
160 / 90	158,5 – 160,5 / 88,5 – 90,5	155,6 – 157,6 / 85,6 – 87,6	17408160	2.173,-	2.173,-
Made to measure					
Front element	to 140 × 220 to 200 × 220		17408500 17408500	2.208,- 2.347,-	2.208,- 2.347,-
Side panel	to 130 × 220				

Please indicate position of the side panel.



ATELIER PLAN



Hinged door with inline panel for recess

8 mm Toughened safety glass (ESG)
with hinges flush with the glass on the inside and clip profile

Version cm	Recess dimensions cm (Height 200)	Article no.	Chrome finish	Black matt
Standard size				
75	73,5 – 75,5	17018075	857,-	857,-
80	78,5 – 80,5	17018080	857,-	857,-
90	88,5 – 90,5	17018090	864,-	864,-
100	98,5 – 100,5	17018100	951,-	951,-
120	118,5 – 120,5	17018120	982,-	982,-
Made to measure				
	to 130 × 220	17018500	1.009,-	1.009,-

Please indicate hinged side of the door.

ATELIER PLAN | Modern lightness with profile



ATELIER PLAN

Hinged door with inline panel and side panel

8 mm Toughened safety glass (ESG)



with hinges flush with the glass on the inside and clip profile

Version cm	Shower tray installation dimensions cm (Height 200)	Tile dimensions cm	Article no.	Chrome finish	Black matt
Standard size hinged door					
80	78,5 – 80,5	75,6 – 77,6	17708080	821,-	821,-
90	88,5 – 90,5	85,6 – 87,6	17708090	869,-	869,-
100	98,5 – 100,5	95,6 – 97,6	17708100	916,-	916,-
Standard size side panel					
80	78,5 – 80,5	75,6 – 77,6	17908080	621,-	621,-
90	88,5 – 90,5	85,6 – 87,6	17908090	658,-	658,-
100	98,5 – 100,5	95,6 – 97,6	17908100	691,-	691,-
Made to measure					
Hinged door	to 130 × 220		17708500	999,-	999,-
Side panel	to 130 × 220 to 130,1 – 160 × 220		17908500 17908500	739,- 810,-	739,- 810,-

Please indicate hinged side of the door.

GLASS OPTIONS



Toughened safety glass, clear glass

-  incl. HSK Shield
-  incl. HSK Shield



TwinSeal

-  + 186,-
-  + 372,-

Smoked glass

-  + 92,-
-  + 184,-

Sandblasted

-  + 124,-
-  + 248,-



Pic. shows optional handle on second door unit

ATELIER PLAN SWINGING

Bi-fold door swinging for recess

8 mm Toughened safety glass (ESG) with hinges flush with the glass on the inside

Version cm	Recess dimensions cm (Height 200)	Article no.	Chrome finish	Black matt
Standard size				
75	73,2 – 74,7	17088075	1.022,-	1.022,-
80	78,2 – 79,7	17088080	1.022,-	1.022,-
90	88,2 – 89,7	17088090	1.056,-	1.056,-
100	98,2 – 99,7	17088100	1.087,-	1.087,-
120	118,2 – 119,7	17088120	1.152,-	1.152,-
Made to measure				
	to 102 × 220	17088500	1.287,-	1.287,-
	to 130 × 200	17088500	1.287,-	1.287,-

Please indicate hinged side of the door.



Pic. shows optional handle on second door unit

ATELIER PLAN SWINGING

Bi-fold corner entry swinging

8 mm Toughened safety glass (ESG) with hinges flush with the glass on the inside

Version cm	Shower tray installation dimensions cm (Height 200)	Tile dimensions cm	Article no.	Chrome finish	Black matt
Standard size					
75	74 – 75,5	71,1 – 72,6	17288010	1.715,-	1.715,-
80	79 – 80,5	76,1 – 77,6	17288014	1.715,-	1.715,-
90	89 – 90,5	86,1 – 87,6	17288018	1.814,-	1.814,-
100	99 – 100,5	96,1 – 97,6	17288019	1.901,-	1.901,-
120	119 – 120,5	116,1 – 117,6	17288028	2.087,-	2.087,-
Made to measure					
	to 102 × 220		17288500	1.996,-	1.996,-
	to 130 × 200		17288500	2.173,-	2.173,-

APERTO



Innovation for new open spaces

APERTO

Convenient access to any room situation: the Aperto hinge allows the door to be opened outwards as well as inwards, offering a wide range of design options.



www.hsk.de/en/gb

HSK
BATHROOM EXPERTS

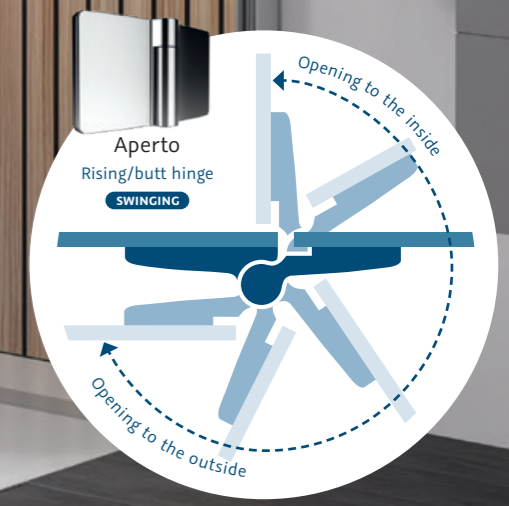

Hinged door swinging with inline panel and side panel.
Shower-set see page 121. RenoDeco wall cladding see page 142 – 159.

APERTO | Innovation for new open spaces



Comfortable

The award-winning Aperto hinge impresses with its spaciousness – the shower door can be swivelled inwards and outwards. Handles, hinges, wall profiles and stabilisation brackets are perfectly coordinated in design.



Easy to clean

All hinges form a perfect unit with the toughened safety glass (ESG) of the shower cubicles, as they are flush with the glass on the inside. This makes cleaning and caring for the glass surfaces particularly easy.



Stable

A solid stabilisation bar also ensures that the glass elements in Aperto are held securely in place. The rounded corners give the shower cubicles a soft look.

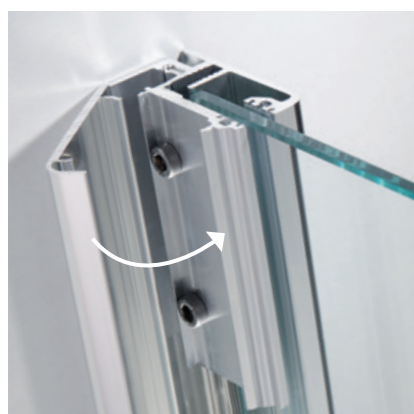

Invisible

The clip profile is also ideally matched to the other elements of the shower cubicles. The concealed installation technology ensures simple installation of the shower cubicles. The smooth surface of the profile is also particularly easy to clean.



Hinged door swinging with inline panel for recess. RenoDeco wall cladding see page 142 – 159.



APERTO SWINGING

Bi-fold door window solution swinging, 5 parts

8/6 mm Toughened safety glass (ESG)

with hinges flush with the glass on the inside, clip profile and buffer handle

Width cm	Height cm	Article no.	Chrome finish	Black matt
Made to measure up to max. 140 or 100 per door, 2 parts		Toughened safety glass, clear glass (50) 2818500	2.313,-	2.313,-

Please enclose a dimensional sketch.

GLASS OPTIONS

Toughened safety glass, clear glass

- incl. HSK Shield
- incl. HSK Shield

TwinSeal

- + 186,-
- + 372,-

Smoked glass

- + 92,-
- + 184,-

Sandblasted

- + 124,-
- + 248,-



APERTO SWINGING

Quadrant swinging, 4 parts

8/6 mm Toughened safety glass (ESG)

with hinges flush with the glass on the inside and clip profile

Version cm	Shower tray installation dimensions cm (Height 200)	Tile dimensions cm	Article no.	Chrome finish	Black matt
Standard size, radius 550					
90	88,5 – 90,5	85,8 – 87,8	2850090550	1.545,-	1.545,-
100 × 90 L*			2850021550	1.643,-	1.643,-
90 × 100 R*			2850020550	1.643,-	1.643,-
100	98,5 – 100,5	95,8 – 97,8	2850100550	1.643,-	1.643,-
120 × 90 L*			2850025550	1.725,-	1.725,-
90 × 120 R*			2850024550	1.725,-	1.725,-
Made to measure					
			to 85 – 130	2850500550	1.798,- 1.798,-

No TwinSeal and Smoked glass possible for round showers.

* The dimension of the matching shower tray is a mirror image. Please take into consideration when ordering.



APERTO SWINGING

Corner entry swinging, 4 parts

8/6 mm Toughened safety glass (ESG)

with hinges flush with the glass on the inside and clip profile

Version cm	Shower tray installation dimensions cm (Height 200)	Tile dimensions cm	Article no.	Chrome finish	Black matt
Standard size					
75 × 90			2820012	1.398,-	1.398,-
80 × 80	78,5 – 80,5	75,7 – 77,7	2820014	1.374,-	1.374,-
80 × 90			2820015	1.398,-	1.398,-
90 × 75			2820016	1.398,-	1.398,-
90 × 80			2820017	1.398,-	1.398,-
90 × 90	88,5 – 90,5	85,7 – 87,7	2820018	1.408,-	1.408,-
100 × 100	98,5 – 100,5	95,7 – 97,7	2820019	1.525,-	1.525,-
80 × 100			2820030	1.491,-	1.491,-
100 × 80			2820031	1.491,-	1.491,-
Made to measure					
			to 130 × 220	2820500	1.597,- 1.597,-



APERTO SWINGING

Hinged door swinging with inline panel and side panel

8/6 mm Toughened safety glass (ESG)

with hinges flush with the glass on the inside and clip profile

Version cm	Shower tray installation dimensions cm (Height 200)	Tile dimensions cm	Article no.	Chrome finish	Black matt
			Toughened safety glass, clear glass (50)		
Standard size hinged door					
80	78,5 – 80,5	75,7 – 77,7	2800080	794,-	794,-
90	88,5 – 90,5	85,7 – 87,7	2800090	817,-	817,-
100	98,5 – 100,5	95,7 – 97,7	2800100	916,-	916,-
Standard size side panel					
80	78,5 – 80,5	75,7 – 77,7	2830080	551,-	551,-
90	88,5 – 90,5	85,7 – 87,7	2830090	586,-	586,-
100	98,5 – 100,5	95,7 – 97,7	2830100	622,-	622,-
Made to measure					
Hinged door	to 130 × 220		2800500	981,-	981,-
Side panel	to 130 × 220		2830500	659,-	659,-

Please indicate hinged side of the door.

GLASS OPTIONS

- Toughened safety glass, clear glass**
 - incl. HSK Shield
 - incl. HSK Shield
- TwinSeal**
 - + 186,-
 - + 372,-
- Smoked glass**
 - + 92,-
 - + 184,-
- Sandblasted**
 - + 124,-
 - + 248,-



APERTO SWINGING

Spacious recess swinging, 3 parts

8/6 mm Toughened safety glass (ESG)

with hinges flush with the glass on the inside and clip profile

Version cm	Recess dimensions cm (Height 200)	Article no.	Chrome finish	Black matt
			Toughened safety glass, clear glass (50)	
Standard size				
140	136 – 140	2803140	1.369,-	1.369,-
160	156 – 160	2803160	1.421,-	1.421,-
180	176 – 180	2803180	1.479,-	1.479,-
Made to measure				
	to 200 × 200	2803500	1.698,-	1.698,-

Please indicate hinged side of the door.



APERTO SWINGING

Hinged door swinging with inline panel for recess

8/6 mm Toughened safety glass (ESG)

with hinges flush with the glass on the inside and clip profile

Version cm	Recess dimensions cm (Height 200)	Article no.	Chrome finish	Black matt
			Toughened safety glass, clear glass (50)	
Standard size				
75	72 – 75	2801075	794,-	794,-
80	77 – 80	2801080	794,-	794,-
90	87 – 90	2801090	817,-	817,-
100	97 – 100	2801100	916,-	916,-
120	117 – 120	2801120	951,-	951,-
Made to measure				
	to 130 × 220	2801500	981,-	981,-

Please indicate hinged side of the door.





The timeless trend in bathroom design

PREMIUM SOFTCUBE

Fresh design for a timeless and modern bathroom design:

This 6 mm series impresses with its extensive programme and wide range of options.



PREMIUM SOFTCUBE | The timeless trend in bathroom design

PREMIUM SOFTCUBE



Shapely

The fresh and soft design is reflected in the handles, hinges, wall profiles and stabilisation brackets. The optional bar handle and practical swing hinges provide additional convenience.



Easy to clean

The hinged and swing door hinges, which are flush with the glass on the inside, form a perfect unit with the toughened safety glass (ESG). This makes cleaning the glass surfaces child's play.



Stable

The Softcube stabilisation bar offers design with function. The glass holder holds the 6 mm thick glass reliably in place. The rounded corners emphasise the uniform look.

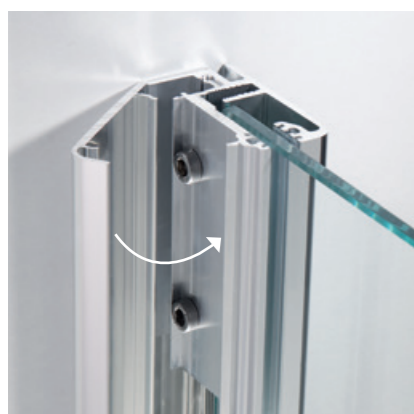

Invisible

The clip profile, which is designed to match the Softcube design language, ensures simple installation of the shower cubicles thanks to its concealed installation technology. The smooth surface of the profile is also particularly easy to clean.



Hinged door with inline panel and side panel and optional bar handle

PREMIUM SOFTCUBE | The timeless trend in bathroom design

PREMIUM SOFTCUBE



PREMIUM SOFTCUBE

Corner entry, 4 parts

6 mm Toughened safety glass (ESG)

with hinges flush with the glass on the inside and clip profile

Version cm	Shower tray installation dimensions cm (Height 200)	Tile dimensions cm	Article no.	Chrome finish	
Standard size					
75 × 90	78,5 – 80,5	75,7 – 77,7	6820012	1.270,-	
80 × 80			6820014	1.243,-	
80 × 90	88,5 – 90,5	85,7 – 87,7	6820015	1.270,-	
90 × 75			6820016	1.270,-	
90 × 80			6820017	1.270,-	
90 × 90	98,5 – 100,5	95,7 – 97,7	6820018	1.282,-	
100 × 100			6820019	1.394,-	
80 × 100	to 130 × 210		6820030	1.358,-	
100 × 80			6820031	1.358,-	
Made to measure					
				6820500	1.458,-

GLASS OPTIONS

- Toughened safety glass, clear glass**
 - incl. HSK Shield
 - incl. HSK Shield
- TwinSeal**
 - + 186,-
 - + 372,-
- Smoked glass**
 - + 92,-
 - + 184,-
- Sandblasted**
 - + 124,-
 - + 248,-



Pic. shows optional bar handle K2 small

PREMIUM SOFTCUBE SWINGING

Hinged door with inline panel and side panel

6 mm Toughened safety glass (ESG) with hinges flush with the glass on the inside and clip profile

Version cm	Shower tray installation dimensions cm (Height 200)	Tile dimensions cm	Article no.	Chrome finish
Standard size hinged door				
75	73,5 – 75,5	70,3 – 72,3	6800075	740,-
80	78,5 – 80,5	75,3 – 77,3	6800080	740,-
90	88,5 – 90,5	85,3 – 87,3	6800090	745,-
100	98,5 – 100,5	95,3 – 97,3	6800100	836,-
120	118,5 – 120,5	115,3 – 117,3	6800120	867,-
Standard size side panel				
75	73,5 – 75,5	70,7 – 72,7	6830075	552,-
80	78,5 – 80,5	75,7 – 77,7	6830080	552,-
90	88,5 – 90,5	85,7 – 87,7	6830090	587,-
100	98,5 – 100,5	95,7 – 97,7	6830100	623,-
Made to measure				
Hinged door	to 130 × 210		6800500	894,-
Side panel	to 130 × 210		6830500	660,-

Please indicate hinged side of the door.

PREMIUM SOFTCUBE

Pentagon, 3 parts

6 mm Toughened safety glass (ESG) with hinges flush with the glass on the inside and clip profile

Version cm	Shower tray installation dimensions cm (Height 200)	Tile dimensions cm	Article no.	Chrome finish	
Standard size					
90	88,5 – 90,5	42,3 – 44,3 / 61,3 /	6860090	1.411,-	
45 / 63,6 / 45*		42,3 – 44,3			
100	98,5 – 100,5	47,3 – 49,3 / 68,4 /	6860100	1.507,-	
50 / 70,7 / 50*		47,3 – 49,3			
Made to measure					
Height to 210				6860500	1.589,-

Please indicate hinged side of the door.

*Size (width): Always specify the size seen from the front of the shower tray.

PREMIUM SOFTCUBE | The timeless trend in bathroom design

PREMIUM SOFTCUBE



PREMIUM SOFTCUBE

Hinged door with inline panel for recess

6 mm Toughened safety glass (ESG)

with hinges flush with the glass on the inside and clip profile

Version cm	Recess dimensions cm (Height 200)	Article no.	Chrome finish
Toughened safety glass, clear glass (50)			
Standard size			
75	73 – 76	6801075	740,-
80	78 – 81	6801080	740,-
90	88 – 91	6801090	745,-
100	98 – 101	6801100	836,-
120	118 – 121	6801120	867,-

Please indicate hinged side of the door.



GLASS OPTIONS

Toughened safety glass, clear glass

incl. HSK Shield

incl. HSK Shield

TwinSeal

+ 186,-

+ 372,-

Smoked glass

+ 92,-

+ 184,-

Sandblasted

+ 124,-

+ 248,-



PREMIUM SOFTCUBE

Quadrant, 3 parts

6 mm Toughened safety glass (ESG)

with hinges flush with the glass on the inside and clip profile

Version cm	Shower tray installation dimensions cm (Height 200)	Article no.	Chrome finish
Toughened safety glass, clear glass (50)			
Standard size, radius 550			
80 × 80	78,5 – 80,5	6853080550	1.530,-
90 × 90	88,5 – 90,5	6853090550	1.530,-
100 × 100	98,5 – 100,5	6853100550	1.658,-
Made to measure			
	to 80 – 120 × 200	6853500550	1.764,-

Please indicate hinged side of the door. No TwinSeal and Smoked glass possible for round showers.



PREMIUM SOFTCUBE

Quadrant, 4 parts

6 mm Toughened safety glass (ESG)

with hinges flush with the glass on the inside and clip profile

Version cm	Shower tray installation dimensions cm (Height 185/200)	Article no.	Chrome finish
Toughened safety glass, clear glass (50)			
Standard size, radius 550			
80	78,5 – 80,5	6850080550	1.383,-
90	88,5 – 90,5	6850090550	1.407,-
100	98,5 – 100,5	6850100550	1.501,-
Standard size, radius 500			
80	78,5 – 80,5	6850080500	1.383,-
90	88,5 – 90,5	6850090500	1.407,-
100	98,5 – 100,5	6850100500	1.501,-
Made to measure			
R 550	to 80 – 120 × 185/200	6850500550	1.622,-
R 500	to 80 – 120 × 185/200	6850500500	1.622,-

No TwinSeal and Smoked glass possible for round showers.

EXKLUSIV 2.0



Technical perfection

EXKLUSIV 2.0

This awardwinning shower cubicle looks as good from the inside as from the outside.



EXKLUSIV 2.0 | Technical perfection

EXKLUSIV 2.0



Tried and tested

The Exklusiv 2.0 shower cubicles series combines the best of its predecessor model with well thought-out details to create a high-quality, modern shower concept. What remains is the familiar functionality and technical performance, without restricting the variability of special dimensions.



Functional

The ergonomic design of the various handle options emphasises the modern appearance of the Exklusiv 2.0. The standard knob handle or optionally available grip-optimised knurled handle always guarantee maximum ease of use and optimum grip safety when opening and closing the doors.



Stable

The visually redesigned stabilisation brackets and wall profiles ensure a contemporary appearance and secure hold. Colour-coordinated, they are available in the profile colours aluminium silver matt, chrome finish or trendy black matt.



Securely fixed

The flat wall connection profile of the side panel offers technical perfection – without visible screw connections – using special keder technology. The fixed elements are inserted into the fixed wall profile, aligned and fixed permanently and tightly. This ensures simple, fast and, above all, secure installation.





Pic. shows optional bar handle

EXKLUSIV 2.0 **SWINGING**



Saloon door with side panel

6 mm Toughened safety glass (ESG) with keder profile for side panel

Version cm	Shower tray installation dimensions cm (Height 200)	Tile dimensions cm	Article no.	Aluminium silver matt	Chrome finish	Black matt
			Toughened safety glass, clear glass (50)			
Standard size saloon door						
75	73,0 – 75	69,4 – 71,4	4810075	606,-	779,-	779,-
80	78,0 – 80	74,4 – 76,4	4810080	606,-	779,-	779,-
90	88,0 – 90	84,4 – 86,4	4810090	648,-	828,-	828,-
100	98,0 – 100	94,4 – 96,4	4810100	708,-	898,-	898,-
Standard size side panel						
75	72,5 – 75	68,9 – 71,4	4840075	419,-	554,-	554,-
80	77,5 – 80	73,9 – 76,4	4840080	419,-	554,-	554,-
90	87,5 – 90	83,9 – 86,4	4840090	449,-	587,-	587,-
100	97,5 – 100	93,9 – 96,4	4840100	477,-	621,-	621,-
Made to measure						
Saloon door	to 160 × 220		4810500	787,-	995,-	995,-
Side panel	to 140 × 220		4840500	518,-	677,-	677,-

Please indicate fixed side of the side panel.

GLASS OPTIONS

- Toughened safety glass, clear glass**
 - incl. HSK Shield
 - incl. HSK Shield
- TwinSeal**
 - + 186,-
 - + 372,-
- Smoked glass**
 - + 92,-
 - + 184,-
- Sandblasted**
 - + 124,-
 - + 248,-



Pic. shows optional bar handle

EXKLUSIV 2.0



Pivot door with side panel

6 mm Toughened safety glass (ESG) with keder profile for side panel

Version cm	Shower tray installation dimensions cm (Height 200)	Tile dimensions cm	Article no.	Aluminium silver matt	Chrome finish	Black matt
			Toughened safety glass, clear glass (50)			
Standard size pivot door						
80	78,0 – 80	74,4 – 76,4	4800080	575,-	740,-	740,-
90	88,0 – 90	84,4 – 86,4	4800090	616,-	791,-	791,-
100	98,0 – 100	94,4 – 96,4	4800100	675,-	854,-	854,-
Standard size side panel						
80	77,5 – 80	73,9 – 76,4	4830080	419,-	554,-	554,-
90	87,5 – 90	83,9 – 86,4	4830090	449,-	587,-	587,-
100	97,5 – 100	93,9 – 96,4	4830100	477,-	621,-	621,-
Made to measure						
Pivot door	to 120 × 220		4800500	740,-	934,-	934,-
Side panel	to 140 × 220		4830500	518,-	677,-	677,-

Please indicate hinged side of the door. U-shaped cabin not possible. Optionally also available as swinging version. Please indicate desired option.



Pic. shows glass option Modesty glass

EXKLUSIV 2.0 **SWINGING**



Corner entry swinging, 2 parts

6 mm Toughened safety glass (ESG)

Version cm	Shower tray installation dimensions cm (Height 200)	Tile dimensions cm	Article no.	Aluminium silver matt	Chrome finish	Black matt
			Toughened safety glass, clear glass (50)			
Standard size						
75 × 90	78 – 80	74,4 – 76,4	4820012	950,-	1.252,-	1.252,-
90	88 – 90	84,4 – 86,4	4820018	989,-	1.299,-	1.299,-
100	98 – 100	94,4 – 96,4	4820019	1.054,-	1.372,-	1.372,-
Made to measure						
	to 120 × 220		4820500	1.162,-	1.502,-	1.502,-



EXKLUSIV 2.0 SWINGING

Bi-fold door swinging with side panel

6 mm Toughened safety glass (ESG)

with hinges flush with the glass on the inside, keder profile for side panel and buffer handle

Version cm	Shower tray installation dimensions cm (Height 200)	Tile dimensions cm	Article no.	Aluminium silver matt	Chrome finish	Black matt
			Toughened safety glass, clear glass (50)			
Standard size bi-fold door						
75	73,0 – 75	69,4 – 71,4	4807075	684,-	906,-	906,-
80	78,0 – 80	74,4 – 76,4	4807080	684,-	906,-	906,-
90	88,0 – 90	84,4 – 86,4	4807090	704,-	940,-	940,-
100	98,0 – 100	94,4 – 96,4	4807100	783,-	1.033,-	1.033,-
Standard size side panel						
75	72,5 – 75	68,9 – 71,4	4836075	436,-	576,-	576,-
80	77,5 – 80	73,9 – 76,4	4836080	436,-	576,-	576,-
90	87,5 – 90	83,9 – 86,4	4836090	467,-	611,-	611,-
100	97,5 – 100	93,9 – 96,4	4836100	497,-	647,-	647,-

Made to measure

Bi-fold door	to 50 – 140 × 220	4807500	831,-	1.082,-	1.082,-
Side panel	to 160 × 220	4836500	539,-	706,-	706,-

Please indicate hinged side of the door. The hinge type Softcube, on the inside of the glass surface, is supplied as standard. Classic hinge shape is optionally available. Please indicate desired hinge shape.

GLASS OPTIONS

- Toughened safety glass, clear glass**
- incl. HSK Shield
- incl. HSK Shield
- TwinSeal**
- + 186,-
- + 372,-
- Smoked glass**
- + 92,-
- + 184,-
- Sandblasted**
- + 124,-
- + 248,-



EXKLUSIV 2.0 SWINGING

Bi-fold corner entry swinging

6 mm Toughened safety glass (ESG)

with hinges flush with the glass on the inside and buffer handle

Version cm	Shower tray installation dimensions cm (Height 200)	Tile dimensions cm	Article no.	Aluminium silver matt	Chrome finish	Black matt
			Toughened safety glass, clear glass (50)			
Standard size						
80	78 – 80	74,4 – 76,4	4826014	1.320,-	1.517,-	1.517,-
80 × 90			4826015	1.330,-	1.564,-	1.564,-
90 × 80			4826017	1.330,-	1.564,-	1.564,-
90	88 – 90	84,4 – 86,4	4826018	1.351,-	1.576,-	1.576,-
100	98 – 100	94,4 – 96,4	4826019	1.453,-	1.646,-	1.646,-
120	118 – 120	114,4 – 116,4	4826028	1.515,-	1.742,-	1.742,-
140	138 – 140	134,4 – 136,4	4826029	1.574,-	1.763,-	1.763,-

Made to measure

	to 50,0 – 100 × 220	4826500	1.511,-	1.694,-	1.694,-
	to 100,1 – 140 × 220	4826500	1.636,-	1.823,-	1.823,-

The hinge type Softcube, on the inside of the glass surface, is supplied as standard. Classic hinge shape is optionally available. Please indicate desired hinge shape.



EXKLUSIV 2.0 SWINGING

Bi-fold corner entry swinging with inline panel

6 mm Toughened safety glass (ESG)

with hinges flush with the glass on the inside, keder profile for side panel and buffer handle

Version cm	Shower tray installation dimensions cm (Height 200)	Tile dimensions cm	Article no.	Aluminium silver matt	Chrome finish	Black matt
			Toughened safety glass, clear glass (50)			
Standard size						
90	87,5 – 90	83,9 – 86,4	4828018	1.453,-	1.666,-	1.666,-
100	97,5 – 100	93,9 – 96,4	4828019	1.541,-	1.737,-	1.737,-
120	117,5 – 120	113,9 – 116,4	4828028	1.600,-	1.824,-	1.824,-

Made to measure

	to 90 – 160 × 220	4828500	1.666,-	1.881,-	1.881,-
--	-------------------	----------------	---------	---------	---------

The hinge type Softcube, on the inside of the glass surface, is supplied as standard. Classic hinge shape is optionally available. Please indicate desired hinge shape.



EXKLUSIV 2.0 SWINGING



Corner entry swinging, 4 parts

6 mm Toughened safety glass (ESG) with keder profile for fixed elements

Version cm	Shower tray installation dimensions cm (Height 200)	Tile dimensions cm	Article no.	Aluminium silver matt	Chrome finish	Black matt
Standard size			Toughened safety glass, clear glass (50)			
80	77,5 – 80	73,9 – 76,4	4825014	1.022,-	1.333,-	1.333,-
90	87,5 – 90	83,9 – 86,4	4825018	1.082,-	1.385,-	1.385,-
100	97,5 – 100	93,9 – 96,4	4825019	1.141,-	1.476,-	1.476,-
Made to measure						
to 140 × 220			4825500	1.257,-	1.616,-	1.616,-

GLASS OPTIONS

Toughened safety glass, clear glass

-  incl. HSK Shield
-  incl. HSK Shield



TwinSeal

-  + 186,-
-  + 372,-

Smoked glass

-  + 92,-
-  + 184,-

Sandblasted

-  + 124,-
-  + 248,-



Pic. shows optional bar handle

EXKLUSIV 2.0 SWINGING

Pentagon swinging, 4 parts

6 mm Toughened safety glass (ESG) with keder profile for fixed elements

Version cm	Shower tray installation dimensions cm (Height 200)	Tile dimensions cm	Article no.	Aluminium silver matt	Chrome finish	Black matt
Standard size			Toughened safety glass, clear glass (50)			
90	87,5 – 90	41,4 – 43,5 / 60,6 / 41 – 43,5 (83,9 – 86,4)	4865090	1.082,-	1.407,-	1.407,-
100	97,5 – 100	46 – 48,5 / 67,6 / 46 – 48,5 (93,9 – 96,4)	4865100	1.162,-	1.513,-	1.513,-
Made to measure						
Height to 200*			4865500	1.233,-	1.581,-	1.581,-

*Size (width): Always specify the size seen from the front of the shower tray.



EXKLUSIV 2.0 SWINGING

Quadrant swinging, 4 parts

6 mm Toughened safety glass (ESG) with keder profile for fixed elements

Version cm	Shower tray installation dimensions cm (Height 200)	Article no.	Aluminium silver matt	Chrome finish	Black matt
Standard size, radius 550			Toughened safety glass, clear glass (50)		
80	77,5 – 80	4855580	1.082,-	1.407,-	1.407,-
90	87,5 – 90	4855590	1.141,-	1.469,-	1.469,-
100	97,5 – 100	4855510	1.233,-	1.581,-	1.581,-
Standard size, radius 500					
80	77,5 – 80	4855080	1.082,-	1.407,-	1.407,-
90	87,5 – 90	4855090	1.141,-	1.469,-	1.469,-
100	97,5 – 100	4855010	1.233,-	1.581,-	1.581,-
Made to measure					
R 550		4855550	1.351,-	1.724,-	1.724,-
R 500		4855050	1.351,-	1.724,-	1.724,-

If necessary, only the fixed elements can be made wider or narrower. No special height possible. No TwinSeal and Smoked glass possible for round showers.

EXKLUSIV 2.0 | Technical perfection



Pic. shows optional bar handle



EXKLUSIV 2.0



Pivot door for recess

6 mm Toughened safety glass (ESG)

Version cm	Recess dimensions cm (Height 200)	Article no.	Aluminium silver matt	Chrome finish	Black matt
Standard size					
75	72 – 75	4801075	575,-	740,-	740,-
80	77 – 80	4801080	575,-	740,-	740,-
83	80 – 83	4801083	575,-	740,-	740,-
87	84 – 87	4801087	575,-	740,-	740,-
90	87 – 90	4801090	616,-	791,-	791,-
93	90 – 93	4801093	616,-	791,-	791,-
97	94 – 97	4801097	616,-	791,-	791,-
100	97 – 100	4801100	675,-	854,-	854,-
103	100 – 103	4801103	675,-	854,-	854,-
Made to measure					
	to 120 × 220	4801500	740,-	934,-	934,-

Please indicate hinged side of the door.
Optionally also available as swinging version. Please indicate desired option.

GLASS OPTIONS

- Toughened safety glass, clear glass**
- incl. HSK Shield
- incl. HSK Shield
- TwinSeal**
- + 186,-
- + 372,-
- Smoked glass**
- + 92,-
- + 184,-
- Sandblasted**
- + 124,-
- + 248,-

EXKLUSIV 2.0 SWINGING



Bi-fold door swinging for recess

6 mm Toughened safety glass (ESG)

with hinges flush with the glass on the inside and buffer handle

Version cm	Recess dimensions cm (Height 200)	Article no.	Aluminium silver matt	Chrome finish	Black matt
Standard size					
75	72 – 75	4806075	704,-	940,-	940,-
80	77 – 80	4806080	704,-	940,-	940,-
83	80 – 83	4806083	704,-	940,-	940,-
87	84 – 87	4806087	704,-	940,-	940,-
90	87 – 90	4806090	726,-	972,-	972,-
93	90 – 93	4806093	726,-	972,-	972,-
97	94 – 97	4806097	726,-	972,-	972,-
100	97 – 100	4806100	800,-	1.066,-	1.066,-
103	100 – 103	4806103	800,-	1.066,-	1.066,-
Made to measure					
	to 50 – 140 × 220	4806500	847,-	1.106,-	1.106,-

Please indicate hinged side of the door. The hinge type Softcube, on the inside of the glass surface, is supplied as standard. Classic hinge shape is optionally available. Please indicate desired hinge shape.

GLASS OPTIONS

- Toughened safety glass, clear glass**
- incl. HSK Shield
- incl. HSK Shield
- TwinSeal**
- + 186,-
- + 372,-
- Smoked glass**
- + 92,-
- + 184,-
- Sandblasted**
- + 124,-
- + 248,-

EXKLUSIV 2.0 | Technical perfection

EXKLUSIV 2.0



Pic. shows optional bar handle



EXKLUSIV 2.0 SWINGING



Saloon door

6 mm Toughened safety glass (ESG)

Version cm	Recess dimensions cm (Height 200)	Article no.	Aluminium silver matt	Chrome finish	Black matt
Standard size					
75	71 – 75	4811075	606,-	779,-	779,-
80	76 – 80	4811080	606,-	779,-	779,-
90	86 – 90	4811090	648,-	828,-	828,-
100	96 – 100	4811100	708,-	898,-	898,-
Made to measure					
	to 160 × 220	4811500	787,-	995,-	995,-

GLASS OPTIONS

Toughened safety glass, clear glass

- incl. HSK Shield
- incl. HSK Shield

TwinSeal

- + 186,-
- + 372,-

Smoked glass

- + 92,-
- + 184,-

Sandblasted

- + 124,-
- + 248,-

EXKLUSIV 2.0 SWINGING



Pivot door swinging with inline panel for recess

6 mm Toughened safety glass (ESG) with keder profile for side panel

Version cm	Recess dimensions cm (Height 200)	Article no.	Aluminium silver matt	Chrome finish	Black matt
Standard size					
120	115,5 – 120	4814120	885,-	1.180,-	1.180,-
140	135,5 – 140	4814140	930,-	1.239,-	1.239,-
160	155,5 – 160	4814160	995,-	1.295,-	1.295,-
Made to measure					
	to 200 × 220	4814500	1.218,-	1.490,-	1.490,-

Please indicate hinged side of the door.

GLASS OPTIONS

Toughened safety glass, clear glass

- incl. HSK Shield
- incl. HSK Shield

TwinSeal

- + 186,-
- + 372,-

Smoked glass

- + 92,-
- + 184,-

Sandblasted

- + 124,-
- + 248,-



REGENCY

Industrial and minimalist design

REGENCY

High-quality sliding rollers and clear lines combined with 8 mm thick glass elements create a light looking quality shower enclosure.

www.hsk.de/en/gb

HSK
BATHROOM EXPERTS



Slider, 2 parts with side panel with optional flat handle.
Shower-set see page 120. RenoDeco wall cladding see page 142 – 159.

REGENCY | Industrial and minimalist design



REGENCY

Recess slider, 2 parts

8 mm Toughened safety glass (ESG)

Version cm	Recess dimensions cm (Height 200)	Article no.	Chrome finish	Black matt	Gold matt
Standard size					
100	98,5 – 100,5	622100	828,-	1.069,-	1.069,-
120	118,5 – 120,5	622120	857,-	1.098,-	1.098,-
140	138,5 – 140,5	622140	944,-	1.185,-	1.185,-
Made to measure					
		622500	1.293,-	1.534,-	1.534,-

Please indicate position of the front fixed panel.

GLASS OPTIONS

Toughened safety glass, clear glass

- incl. HSK Shield
- incl. HSK Shield

TwinSeal

- + 186,-
- + 372,-

Smoked glass

- + 92,-
- + 184,-

Sandblasted

- + 124,-
- + 248,-



REGENCY

Slider, 2 parts with side panel

8 mm Toughened safety glass (ESG)

Version cm	Shower tray installation dimensions cm (Height 200)	Tile dimensions cm	Article no.	Chrome finish	Black matt	Gold matt
Standard size						
100 / 80	98,5 – 100,5 / 78,5 – 80,5	95,7 – 97,7 / 75,7 – 77,7	642100	1.218,-	1.534,-	1.534,-
120 / 80	118,5 – 120,5 / 78,5 – 80,5	115,7 – 117,7 / 75,7 – 77,7	642120	1.247,-	1.563,-	1.563,-
120 / 90	118,5 – 120,5 / 88,5 – 90,5	115,7 – 117,7 / 85,7 – 87,7	640120	1.293,-	1.609,-	1.609,-
140 / 90	138,5 – 140,5 / 88,5 – 90,5	135,7 – 137,7 / 85,7 – 87,7	640140	1.380,-	1.696,-	1.696,-
Made to measure						
			640500	1.741,-	2.057,-	2.057,-

Please indicate position of the side panel



REGENCY

Slider corner entry, 4 parts

8 mm Toughened safety glass (ESG)

Version cm	Shower tray installation dimensions cm (Height 200)	Tile dimensions cm	Article no.	Chrome finish	Black matt	Gold matt
Standard size						
90 × 90	88,5 – 90,5 / 88,5 – 90,5	85,7 – 87,7 / 85,7 – 87,7	621018	1.339,-	1.625,-	1.625,-
100 × 100	98,5 – 100,5 / 98,5 – 100,5	85,7 – 87,7 / 85,7 – 87,7	621019	1.392,-	1.683,-	1.683,-
Made to measure						
			621500	1.631,-	1.923,-	1.923,-



Gentle comfort with character

SOLIDA

Clear shapes, high-quality materials
and extra smooth ease of use: this is
the Solida – a threshold-free dream
shower with a solid character.

www.hsk.de/en/gb



Corner entry slider, 4 parts (no bottom profile)

SOLIDA | Gentle comfort with character

SOLIDA



Modern

Stability and durability:
These are the characteristics of the tried and tested 8 mm Solida series. The design of the profiles and the handles look modern and robust at the same time.



High-quality

The Solida models are equipped with a slide guide that moves the large real glass doors smoothly and quietly.



Optional extra soft

The optional soft-close mechanism enables extra-soft opening and closing. It pulls the large door element easily and independently into its opening and closing position.

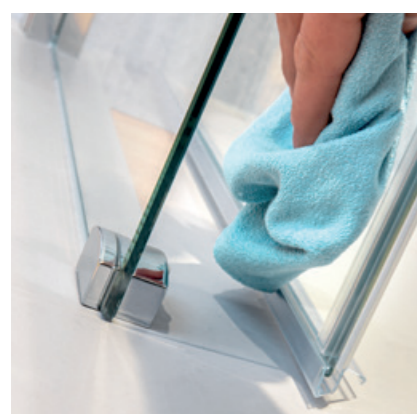

Barrier-free

The all-metal door guide connects the fixed glass element securely to the floor. The sliding door is guided gently past the fixed element. The deliberate omission of a bottom guide rail enables threshold-free access.





SOLIDA

Slider, 2 parts with side panel (no bottom profile)

8 mm Toughened safety glass (ESG) with swing-out door elements and magnetic glider

Version cm	Shower tray installation dimensions cm (Height 200)	Tile dimensions cm	Article no.	Aluminium silver matt	Chrome finish
			Toughened safety glass, clear glass (50)		
Standard size slider			1526120	799,-	899,-
120	117,0 – 121,0		1526140	849,-	949,-
140	137,0 – 141,0		1526160	899,-	999,-
160	157,0 – 161,0				
Standard size side panel					
75	73,5 – 75,5	70,3 – 72,3	1533075	449,-	529,-
80	78,5 – 80,5	75,3 – 77,3	1533080	449,-	529,-
90	88,5 – 90,5	85,3 – 87,3	1533090	479,-	559,-
100	98,5 – 100,5	95,3 – 97,3	1533100	519,-	599,-
Made to measure					
Slider	to 160,1 – 200 × 200		1526500	1.149,-	1.249,-
Side panel	to 140 × 200		1533500	699,-	779,-

Please indicate position of the front fixed panel.

SOLIDA

Corner entry slider, 4 parts (no bottom profile)



8 mm Toughened safety glass (ESG) with swing-out door elements and magnetic glider

Version cm	Shower tray installation dimensions cm (Height 200)	Tile dimensions cm	Article no.	Aluminium silver matt	Chrome finish
			Toughened safety glass, clear glass (50)		
Standard size			1525014	1.199,-	1.399,-
80	78,5 – 80,5	75,3 – 77,3	1525018	1.269,-	1.469,-
90	88,5 – 90,5	85,3 – 87,3	1525019	1.349,-	1.549,-
100	98,5 – 100,5	95,3 – 97,3	1525028	1.499,-	1.699,-
120	118,5 – 120,5	115,3 – 117,3			
Made to measure					
	120,1 – 140 × 200		1525500	1.579,-	1.779,-

For technical reasons, the soft-close mechanism is only possible from a width of 900 mm.

GLASS OPTIONS

Toughened safety glass, clear glass

-  incl. HSK Shield
-  incl. HSK Shield



TwinSeal

-  + 186,-
-  + 372,-

Smoked glass

-  + 92,-
-  + 184,-

Sandblasted

-  + 124,-
-  + 248,-

Magnetic glider

The technically modified magnetic glide on the Solida ensures that the door is guided almost contact-free, while the doors run smoothly and are reliably stable. The innovative folding mechanism in the door guide is particularly practical. Thanks to this, the shower door can be swivelled inwards for easy cleaning.



Easy to fold down



Easy to clean

Modern design and strong presence

FAVORIT PLUS

Timeless beauty with a modern
look and functionality.
The ideal solution – not just for
tricky bathrooms.



FAVORIT PLUS | Modern design and strong presence

FAVORIT PLUS



Good grip

A special feature of the Favorit Plus is the grip-optimised door handle with knurled structure. It gives the shower cubicles an exclusive look and provides an extra portion of comfort when handling.



Functional

Sophisticated technology without compromise: The glass door is mounted between two pivot points set back from the wall, making it suitable for use in tricky bathrooms.



Reliable

With its striking profile design, the Favorit Plus pivot door is an eye-catcher in any bathroom. The magnetic closing strip ensures that the 6 mm toughened safety glass doors close cleanly and reliably. Convenient access is possible thanks to the particularly flat floor profile.



Easy to clean

The optional HSK Shield closes the invisible pores of the glass. This noticeably reduces the drying of water droplets and the build-up of soap residue, dirt and limescale. This makes regular cleaning easier.



FAVORIT PLUS | Modern design and strong presence



FAVORIT PLUS

Pivot door for recess
6 mm Toughened safety glass (ESG)

Version cm	Recess dimensions cm (Height 200)	Article no.	Aluminium silver matt	White matt	Black matt
Toughened safety glass, clear glass (50)					
Standard size					
75	72 – 75	3500075	569,-	699,-	699,-
80	77 – 80	3500080	569,-	699,-	699,-
90	87 – 90	3500090	579,-	719,-	719,-
100	97 – 100	3500100	599,-	749,-	749,-
Made to measure					
	65 – 120 × 165 – 200	3500500	762,-	975,-	975,-

GLASS OPTIONS

Toughened safety glass, clear glass

- incl. HSK Shield
- incl. HSK Shield

TwinSeal

- + 186,-
- + 372,-

Smoked glass

- + 92,-
- + 184,-

Sandblasted

- + 124,-
- + 248,-



FAVORIT PLUS

Saloon door for recess
6 mm Toughened safety glass (ESG)

Version cm	Recess dimensions cm (Height 200)	Article no.	Aluminium silver matt	White matt	Black matt
Toughened safety glass, clear glass (50)					
Standard size					
80	77 – 80	3511080	649,-	799,-	799,-
90	87 – 90	3511090	669,-	819,-	819,-
100	97 – 100	3511100	699,-	849,-	849,-
Made to measure					
	75 – 120 × 165 – 200	3511500	849,-	999,-	999,-



FAVORIT PLUS

Pivoting bi-fold door for recess
6 mm Toughened safety glass (ESG)

Version cm	Recess dimensions cm (Height 200)	Article no.	Aluminium silver matt	Black matt
Toughened safety glass, clear glass (50)				
Standard size				
80	77 – 80	3560080	649,-	799,-
90	87 – 90	3560090	669,-	819,-
100	97 – 100	3560100	699,-	849,-
Made to measure				
	65 – 120 × 165 – 200	3560500	849,-	999,-
Optional door handle Favorit Plus (86)				49,-



FAVORIT PLUS

Side panel for pivot door, pivoting bi-fold door and saloon door
6 mm Toughened safety glass (ESG)

Version cm	Shower tray installation dimensions cm (Height 200)	Article no.	Aluminium silver matt	White matt	Black matt
Toughened safety glass, clear glass (50)					
Standard size					
80	78,5 – 80,5	3300080	309,-	318,-	318,-
90	88,5 – 90,5	3300090	334,-	338,-	338,-
100	98,5 – 100,5	3300100	358,-	372,-	372,-
Made to measure					
	25 – 120 × 50 – 200	3300500	484,-	531,-	531,-

FAVORIT PLUS | Modern design and strong presence

FAVORIT PLUS



FAVORIT PLUS

Recess slider, 2 parts (with bottom profile)
6 mm Toughened safety glass (ESG)



Version cm	Recess dimensions cm (Height 200)	Article no.	Aluminium silver matt	Black matt
Toughened safety glass, clear glass (50)				
Standard size				
120	116 – 120	3522120	699,-	799,-
140	136 – 140	3522140	749,-	849,-
Made to measure	120 – 160	3522500	999,-	1.099,-

GLASS OPTIONS

Toughened safety glass, clear glass

- incl. HSK Shield
- incl. HSK Shield

TwinSeal

- + 186,-
- + 372,-

Smoked glass

- + 92,-
- + 184,-

Sandblasted

- + 124,-
- + 248,-

FAVORIT PLUS

Side panel for recess slider, 2 parts (with bottom profile)
6 mm Toughened safety glass (ESG)



Version cm	Shower tray installation dimensions cm (Height 200)	Article no.	Aluminium silver matt	Black matt
Toughened safety glass, clear glass (50)				
Standard size				
80	78 – 80	3533080	309,-	318,-
90	88 – 90	3533090	334,-	338,-
Made to measure	25 – 120	3533500	484,-	531,-

GLASS OPTIONS

Toughened safety glass, clear glass

- incl. HSK Shield
- incl. HSK Shield

TwinSeal

- + 186,-
- + 372,-

Smoked glass

- + 92,-
- + 184,-

Sandblasted

- + 124,-
- + 248,-

Your individual shower experience

MADE TO MEASURE

There is no don't have, or can't do: We can supply customised shower cubicles for unusual spaces or requirements quickly and at competitive prices, most size variations are possible.





Made to measure options

With HSK the sky is the limit

There is no don't have, or can't do: We can supply customised shower cubicles for unusual spaces or requirements quickly and at competitive prices, most size variations are possible. We also offer a large variety of profile colours and different glass options. Delivery time approximately 3 – 6 weeks including delivery.



Selection options

Walk In

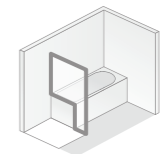
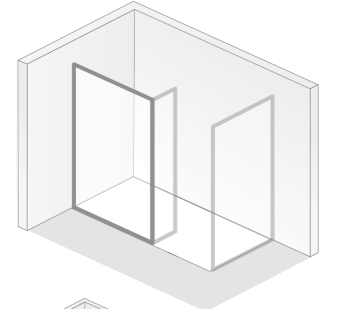

Cut out

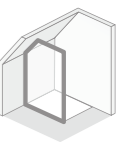

Roof pitch cut

Recess

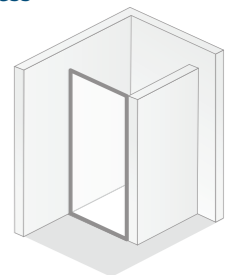

Roof pitch cut

Corner

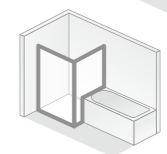
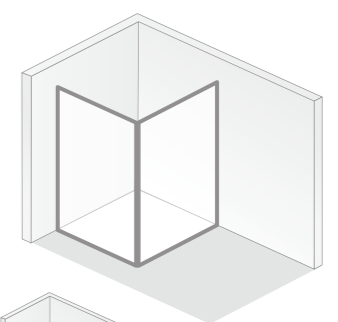

Cut out



The basis of all showering pleasure

SHOWER TRAYS

HSK shower trays are just as impressive in terms of design, quality and price as the innovative product solutions for barrier-free bathrooms.



SHOWER TRAYS | The basis of all showering pleasure



MARBLE-POLYMER SHOWER TRAY, STONE LOOK, SQUARE

Height without feet approx. 4 cm

Dimension in cm	Net weight in kg	Article no.	Price
90 × 90	51	5825090	668,-
100 × 100	63	5825010	703,-
120 × 120	91	5825012	821,-

Due to the stone-look surface, it is not possible for the water to run off completely without leaving any residue. No factory anti-slip coating possible for anthracite colour.

Colour range



Height-adjustable legs
for optimum adjustment of the shower tray even on uneven floors.

Optional

AntiSlip – Increased safety

All shower trays can be equipped with a protective layer on the factory side for increased slip resistance.

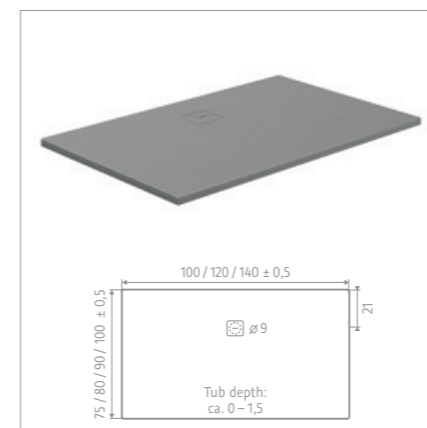

MARBLE-POLYMER SHOWER TRAY, STONE LOOK, RECTANGULAR

Height without feet approx. 4 cm

Dimension in cm	Net weight in kg	Article no.	Price
75 × 100	48	5825710	642,-
75 × 120	57	5825712	675,-
75 × 140	67	5825714	709,-
80 × 100	51	5825100	658,-
80 × 120	61	5825125	698,-
80 × 140	71	5825145	735,-
90 × 100	57	5825095	691,-
90 × 120	68	5825120	725,-
90 × 140	79	5825140	758,-
100 × 120	76	5825112	742,-
100 × 140	86	5825114	779,-

Due to the stone-look surface, it is not possible for the water to run off completely without leaving any residue. No factory anti-slip coating possible for anthracite colour.

Colour range

CUSTOMISED CUTTING

Flexible and precise

In practice, there are often complex and individual installation situations that place special demands on a shower tray, for example:

- Supply and installation shafts protrude into the shower zone
- Walls deviate from the vertical dimension
- The position of the drain set has to be changed for structural reasons
- The standard sizes of the shower tray simply do not fit

With bevelled cuts or precisely fitting cut-outs on all sides, the marble-polymer shower tray in stone look is suitable for almost all installation situations and offers maximum installation flexibility in addition to the wide range of standard sizes.

Cutting options

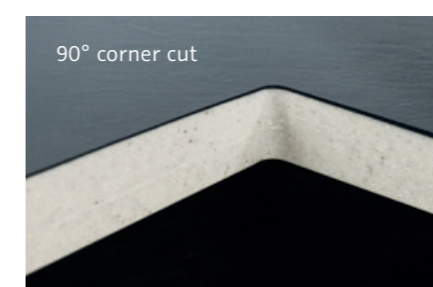
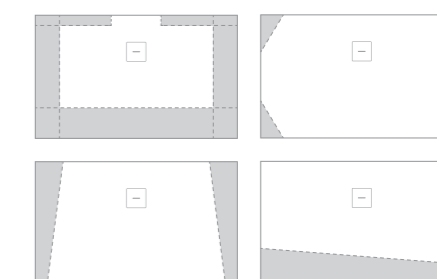

90° corner cut



Diagonal cut



To avoid customised shower cubicles, the shower tray should be tiled in by a maximum of 1 cm.

All shower trays incl. height-adjustable feet, mounting rails and waste-set.

SHOWER TRAYS | The basis of all showering pleasure

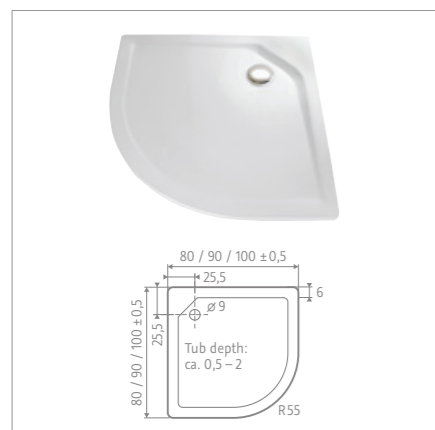

ACRYLIC SHOWER TRAY EXTRA FLAT, QUADRANT

Made from 5 mm ICI acrylic, height without feet approx. 3,5 cm, radius 55 cm

Dimension in cm	Article no.	White
80 × 80	505080	369,-
90 × 90	505090	385,-
100 × 100	505100	425,-



ACRYLIC SHOWER TRAY EXTRA FLAT, SQUARE

Made from 5 mm ICI acrylic, height without feet approx. 3,5 cm

Dimension in cm	Article no.	White
80 × 80	525080	271,-
90 × 90	525090	300,-
100 × 100	525010	352,-

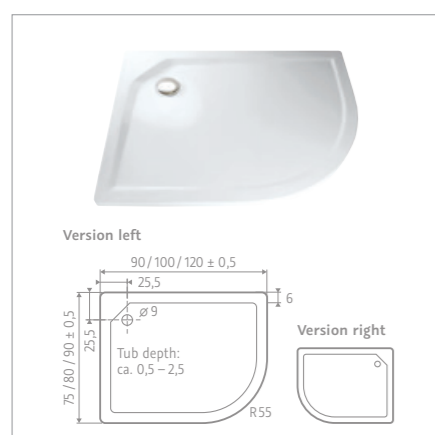

ACRYLIC SHOWER TRAY EXTRA FLAT, QUADRANT ASYMMETRIC

Made from 5 mm ICI acrylic, height without feet approx. 3,5 cm, radius 55 cm

Dimension in cm		Article no.		White
Version left	Version right	Version left	Version right	
75 × 90	90 × 75	505079	505097	369,-
80 × 90	90 × 80	505171	505151	374,-
90 × 100	100 × 90	505211	505201	419,-
90 × 120	120 × 90	505250	505240	474,-

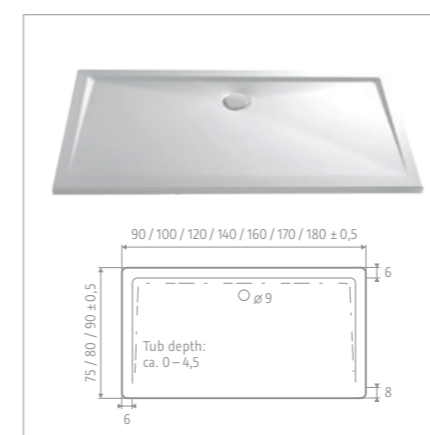

ACRYLIC SHOWER TRAY EXTRA FLAT, RECTANGULAR

Made from 5 mm ICI acrylic, height without feet approx. 3,5 - 4,5 cm

Dimension in cm	Article no.	White
75 × 90	525075	271,-
75 × 160	525070	497,-
75 × 170	525170	513,-
80 × 90	525085	368,-
80 × 100	525100	381,-
80 × 120	525125	408,-
80 × 160	525165	513,-
80 × 170	525175	529,-
80 × 180	525185	547,-
90 × 100	525095	401,-
90 × 120	525120	438,-
90 × 140	525140	474,-
90 × 160	525160	553,-

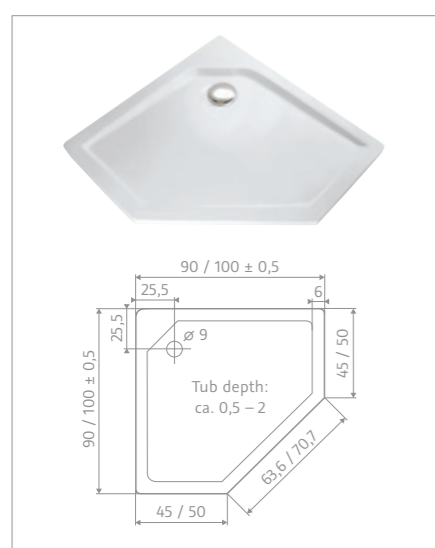

ACRYLIC SHOWER TRAY EXTRA FLAT, PENTAGON

Made from 5 mm ICI acrylic, height without feet approx. 3,5 cm

Dimension in cm	Article no.	White
90 × 90	515090	385,-
100 × 100	515100	425,-

Mounting rails

for solid support of the wall-mounted side of acrylic shower trays.

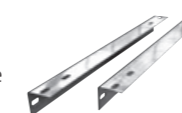

Height-adjustable legs

for optimum adjustment of the shower tray even on uneven floors.



SHOWER TRAYS | The basis of all showering pleasure

SHOWER TRAYS

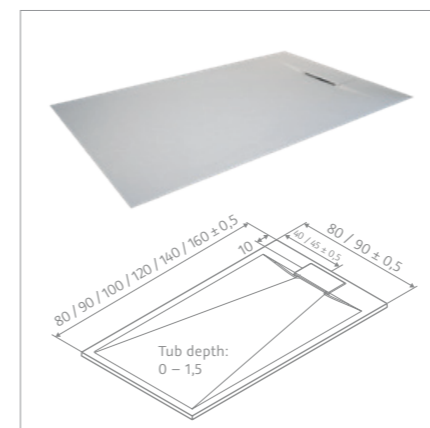
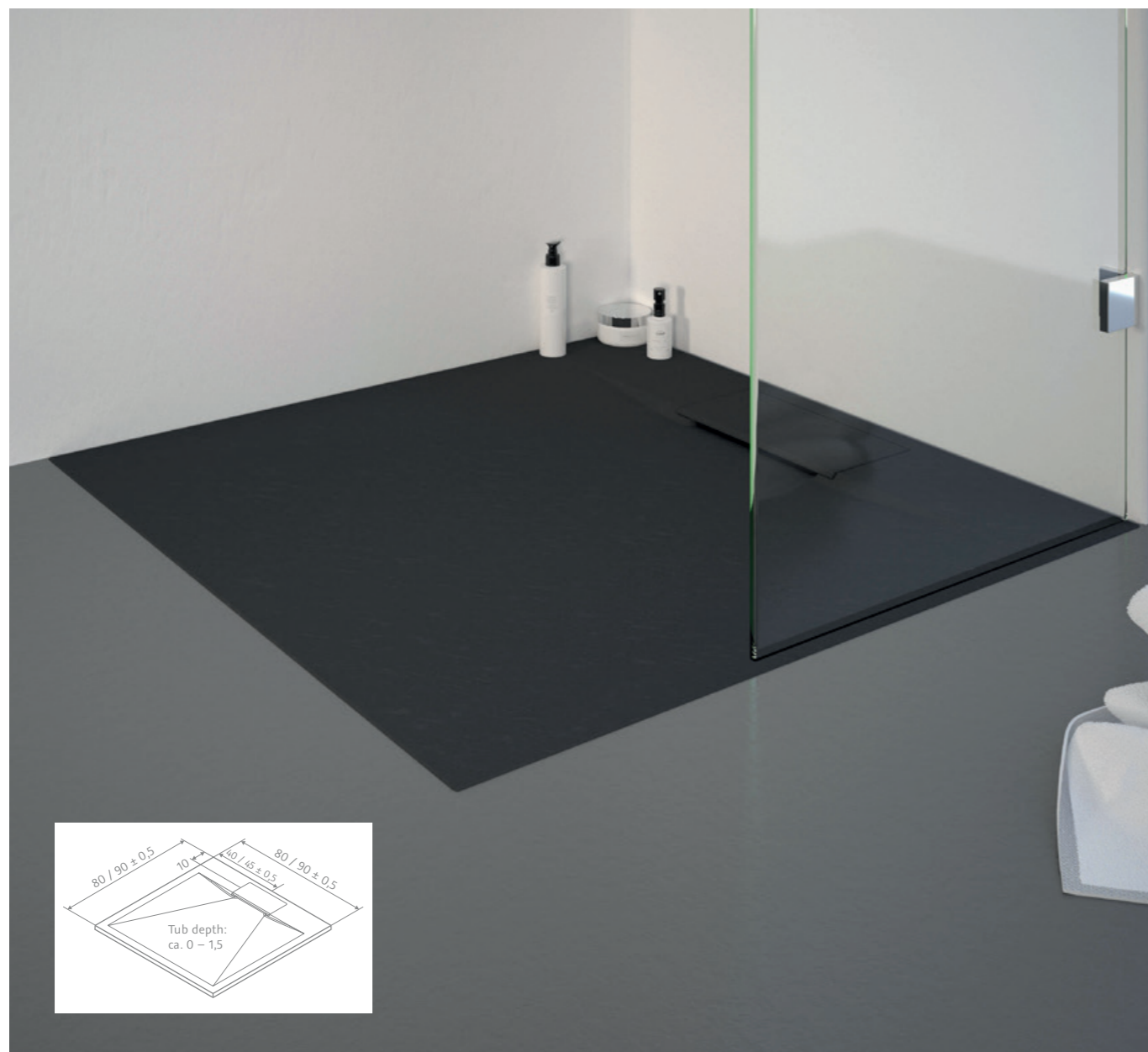

IMITATION STONE SHOWER TRAY, RECTANGULAR

Height without feet approx. 3,2 cm

Dimension in cm	Net weight in kg	Article no.	White matt	Anthracite black
90 × 80	11.07	5165085	377,-	377,-
100 × 80	12.26	5165100	392,-	392,-
120 × 80	14.63	5165125	421,-	421,-
140 × 80	17.01	5165145	450,-	450,-
160 × 80	19.40	5165165	479,-	479,-
100 × 90	13.74	5165095	406,-	406,-
120 × 90	16.41	5165120	435,-	435,-
140 × 90	19.08	5165140	479,-	479,-
160 × 90	21.75	5165160	508,-	508,-
150 × 70	15.85	5165715	494,-	494,-
160 × 70	16.91	5165716	508,-	508,-
170 × 70	17.97	5165717	523,-	523,-

Waste Ø 90 mm and legs not included.

Optional accessories

Installation legs	Artikel no.	Version	White
12 Installation legs and 2 fitting rails	599996	Shower tray up to 100	119,-
15 Installation legs and 4 fitting rails	599997	Shower tray > 100	167,-

IMITATION STONE SHOWER TRAY, SQUARE

Height without feet approx. 3,2 cm

Dimension in cm	Net weight in kg	Article no.	White matt	Anthracite black
80 × 80	9.9	5165080	363,-	363,-
90 × 90	12.4	5165090	392,-	392,-

Waste Ø 90 mm and legs not included.

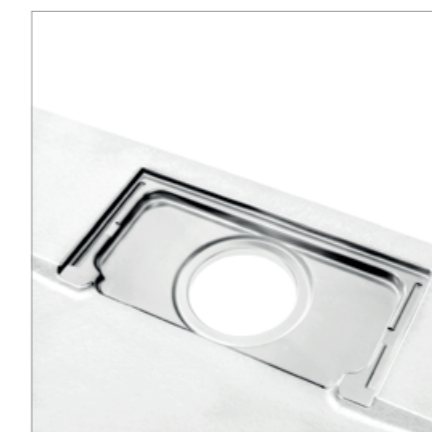
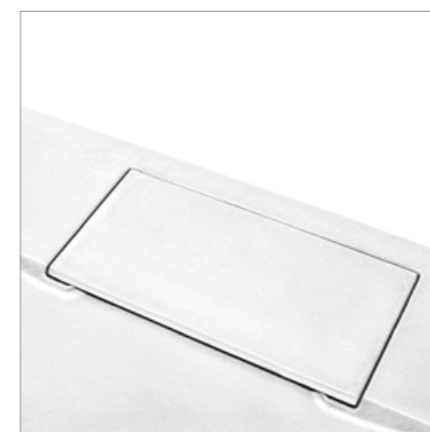

To avoid customised shower cubicles, the shower tray should be tiled in by a maximum of 1 cm.



Shower comfort in the bath

BATH SCREENS

Combine showering comfort with bathing pleasure and fulfil your dream of an individual bathroom.

Choose from a wide variety of models, colours and glass.





Pic. shows glass option Modesty glass



Please indicate hinged side of the bath screen.
The swingable element can be manufactured up to a maximum width of 700 mm.



K2^P SWINGING

K2^P bath screen swinging

8 mm Toughened safety glass (ESG) with hinges flush with the glass on the inside

Version cm	Element dimensions cm (Height 140)	Article no.	Chrome finish
Standard size		Toughened safety glass, clear glass (50)	
75	74,5	2106075	794,-
Made to measure	to 100 × 160	2106500	938,-

Please indicate hinged side of the bath screen.

K2^P SWINGING

K2^P bath screen swinging with inline panel

8 mm Toughened safety glass (ESG) with hinges flush with the glass on the inside

Version cm	Element dimensions cm (Height 140)	Article no.	Chrome finish
Standard size		Toughened safety glass, clear glass (50)	
120	70 / 50	2106114	1.009,-
Made to measure	to 140 × 160	2106555	1.173,-

Please indicate hinged side of the bath screen.
The swingable element can be manufactured up to a maximum width of 700 mm.

K2^P SWINGING

K2^P bi-fold bath screen swinging

8 mm Toughened safety glass (ESG) with hinges flush with the glass on the inside

Version cm	Element dimensions cm (Height 140)	Article no.	Chrome finish
Standard size		Toughened safety glass, clear glass (50)	
114	65 / 49	2106112	1.115,-
Made to measure	to 120 × 160	2106600	1.279,-

Please indicate hinged side of the bath screen.

PREMIUM SOFTCUBE SWINGING

Premium Softcube bi-fold bath screen swinging, 2 parts



6 mm Toughened safety glass (ESG) with hinges flush with the glass on the inside

Version cm	Element dimensions cm (Height 140)	Article no.	Aluminium silver matt	Chrome finish
Standard size		Toughened safety glass, clear glass (50)		
90	48 / 40	6806090	436,-	704,-
100	55 / 43	6806100	479,-	747,-
114	69 / 43	6806114	479,-	747,-
Made to measure	to 120 × 150	6806500	677,-	967,-

Please indicate hinged side of the bath screen.

GLASS OPTIONS



Toughened safety glass, clear glass

-  incl. HSK Shield
-  incl. HSK Shield



TwinSeal

-  + 186,-
-  + 372,-

Smoked glass

-  + 92,-
-  + 184,-

Sandblasted

-  + 124,-
-  + 248,-



APERTO SWINGING

Aperto bath screen swinging with inline panel

8/6 mm Toughened safety glass (ESG)

with hinges flush with the glass on the inside, clip profile and buffer handle

Version cm	Element dimensions cm (Height 150)	Article no.	Chrome finish	Black matt
Standard size				
90	88,5 – 90,5	2806090	857,-	857,-
100	98,5 – 100,5	2806100	893,-	893,-
114	112,5 – 114,5	2806114	893,-	893,-
Made to measure				
to 120 × 100 – 150		2806500	1.028,-	1.028,-

Please indicate hinged side of the bath screen.

GLASS OPTIONS

Toughened safety glass, clear glass

■ incl. HSK Shield

■ incl. HSK Shield

TwinSeal

■ + 186,-

■ + 372,-

Smoked glass

■ + 92,-

■ + 184,-

Sandblasted

■ + 124,-

■ + 248,-



APERTO SWINGING

Aperto bi-fold bath screen swinging with inline panel

8/6 mm Toughened safety glass (ESG)

with hinges flush with the glass on the inside, clip profile and buffer handle

Version cm	Element dimensions cm (Height 150)	Article no.	Chrome finish	Black matt
Standard size				
90	88,5 – 90,5	2807090	927,-	927,-
100	98,5 – 100,5	2807100	963,-	963,-
114	112,5 – 114,5	2807114	963,-	963,-
Made to measure				
to 120 × 100 – 150		2807500	1.092,-	1.092,-

Please indicate hinged side of the bath screen.



FAVORIT SWINGING

Favorit bath screen swinging, 1 part

Version cm	Element dimensions cm (Height 140)	Article no.	Chrome finish	Black matt	Gold matt
Standard size					
80	79	162089	230,-	230,-	230,-
Made to measure					
to 125 × 140		162500	322,-	322,-	322,-

Please indicate hinged side of the bath screen.



PURE PRO SWINGING

Pure Pro bath screen swinging with inline panel

8 mm Toughened safety glass (ESG)

Version cm	Element dimensions cm (Height 140)	Article no.	Chrome finish, stainless steel finish	Black matt, white matt	Brushed gunmetal/ gold/ copper
Standard size					
140	140	2660500	1.178,-	1.178,-	1.659,-
Made to measure					
to 140 × 160		2660500	1.178,-	1.178,-	1.659,-

Colour range



Individual showering pleasure

SHOWER & CO

Perfectly harmonised variety for all aspects of water – the fittings and components for showers, baths and washbasins.

www.hsk.de/en/gb



Shower-set AquaXPro 200 thermostat, brushed gunmetal with Toughened safety glass shelf (ESG) black.
RenoDeco wall cladding see page 142 – 159.

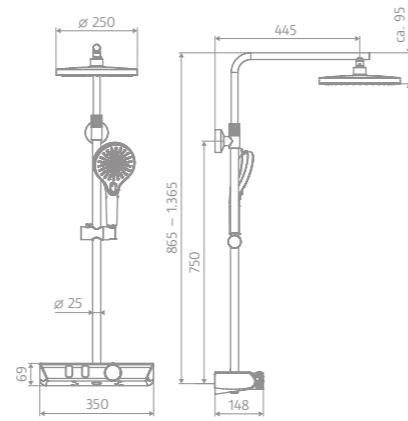

**SHOWER-SET
AQUAXPRO 200 THERMOSTAT**

Article no.	Chrome	Brushed gunmetal
1007200	988,-	1.281,-

Colours

- Chrome (02)
with Toughened safety glass shelf (ESG) white
- Brushed gunmetal (280)
with Toughened safety glass shelf (ESG) black

- Safety thermostat with 38 °C locking
- Cold water fail-safe device
- Incl. backflow preventer
- Ceramic slide regulators for adjusting the water volume
- Possibility of thermal disinfection
- Grip-optimised functional elements for greater ease of use
- AquaXPro overhead shower, \varnothing 250 x 18 mm, swivelling and height adjustable
- AquaXPro designer hand shower with three spray modes (Rain, SoftRain, Massage) and height adjustable holder
- Anti scale nozzles
- Shower hose 1.5 m with anti-twist protection on both sides
- Incl. installation accessories

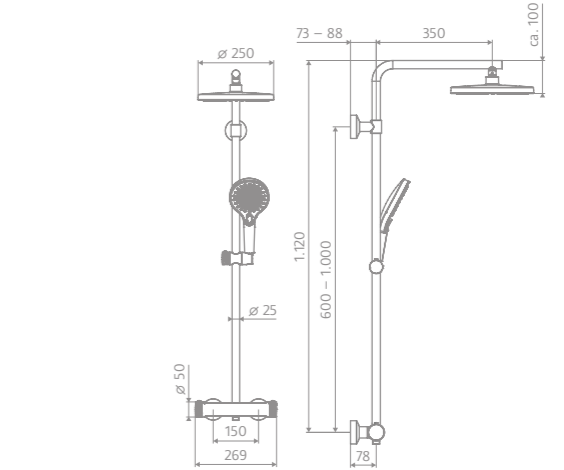

**SHOWER-SET
AQUAXPRO 100 THERMOSTAT**

Article no.	Chrome	Black matt	Brushed gunmetal	Brushed copper
1007100	712,-	916,-	916,-	916,-

Colours

- Chrome (02)
- Black matt (68)
- Brushed gunmetal (280)
- Brushed copper (282)

- Safety thermostat with 38 °C locking and integrated diverter
- Cold water fail-safe device
- Incl. backflow preventer
- Possibility of thermal disinfection
- Grip-optimised functional elements for greater ease of use
- AquaXPro overhead shower, \varnothing 250 x 18 mm, swivelling
- Height adjustable wall connection (existing drill holes can be used or covered)
- AquaXPro designer hand shower with three spray modes (Rain, SoftRain, Massage) and height adjustable holder
- Anti scale nozzles
- Shower hose 1.5 m with anti-twist protection on both sides
- Incl. installation accessories



The dimension depends on the position of the S-connections and may vary slightly due to the manufacturing process. All dimensions are subject to a tolerance of \pm 5 mm.



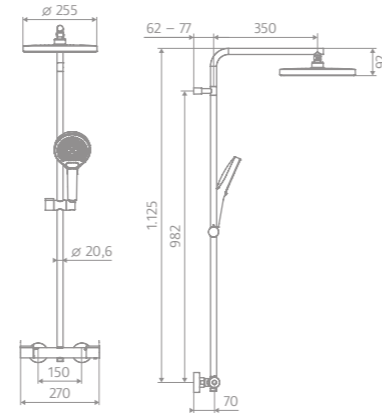

Shower-set RS Slim thermostat
black matt (68)



**SHOWER-SET
RS SLIM THERMOSTAT**

Article no.	Chrome	Black matt	Brushed gunmetal
1003500	508,-	712,-	712,-

Colours

-  Chrome (02)
-  Black matt (68)
-  Brushed gunmetal (280)

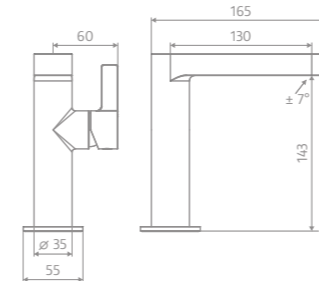

- Safety thermostat with 38 °C locking and integrated diverter
- Cold water fail-safe device
- Incl. backflow preventer
- Overhead shower Rund, ø 255 x 20 mm, swivelling
- Designer hand shower Rund with three spray modes (Rain, SoftRain, Massage) and height adjustable holder
- Anti scale nozzles
- Shower hose 1.5 m with anti-twist protection on both sides
- Incl. installation accessories



**SINGLE LEVER BASIN
MIXER SLIM ROUND**

Article no.	Chrome	Black matt	Brushed gunmetal
1100350	140,-	181,-	181,-

Colours

-  Chrome (02)
-  Black matt (68)
-  Brushed gunmetal (280)



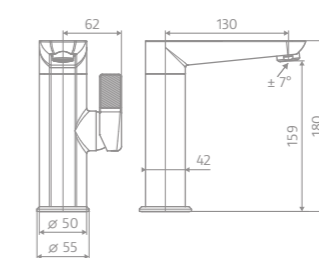

- 1-hole
- Ceramic cartridge
- Projection 130 mm
- Flexible connection hoses G $\frac{3}{8}$
- Adjustable aerator ($\pm 7^\circ$)



**SINGLE LEVER BASIN
MIXER AQUAXPRO**

Article no.	Chrome	Black matt	Brushed gunmetal / copper
1100700	255,-	325,-	325,-

Colours

-  Chrome (02)
-  Black matt (68)
-  Brushed gunmetal (280)
-  Brushed copper (282)

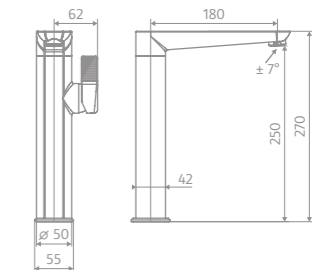

- 1-hole
- Ceramic cartridge
- L-shaped spout, 360° swivelling
- Projection 130 mm
- Flexible connection hoses G $\frac{3}{8}$
- Adjustable aerator ($\pm 7^\circ$)
- Quick and twist-proof fastening technology
- Grip-optimised functional elements for greater ease of use



**SINGLE LEVER BASIN
MIXER AQUAXPRO HIGH**

Article no.	Chrome	Black matt	Brushed gunmetal / copper
1100710	318,-	414,-	414,-

Colours

-  Chrome (02)
-  Black matt (68)
-  Brushed gunmetal (280)

- 1-hole
- Ceramic cartridge
- L-shaped spout, 360° swivelling
- Projection 180 mm
- Flexible connection hoses G $\frac{3}{8}$
- Adjustable aerator ($\pm 7^\circ$)
- Quick and twist-proof fastening technology
- Grip-optimised functional elements for greater ease of use

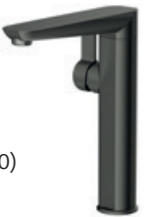

Optional accessories

Clicker waste

The practical pop-up washbasin catch opens and closes at the touch of a finger. The tap used therefore does not require a pull rod.

Artikel no.	Chrome	Black matt	Brushed gunmetal / copper
1100058	46,-	68,-	68,-



The dimension depends on the position of the S-connections and may vary slightly due to the manufacturing process. All dimensions are subject to a tolerance of ± 5 mm.



**COMPLETE-SET 1.30
AQUAXPRO**

Article no.	Chrome	Brushed gunmetal
1007300	480,-	611,-

Colours



-  Chrome (02) with Toughened safety glass shelf (ESG) white
-  Brushed gunmetal (280) with Toughened safety glass shelf (ESG) black

- AquaXPro surface-mounted shower thermostat with 38 °C locking
- AquaXPro designer hand shower with three spray modes (Rain, SoftRain, Massage) and hand shower holder
- Shower hose 1.5 m with anti-twist protection on both sides

**COMPLETE-SET 1.35
AQUAXPRO**

Article no.	Chrome	Brushed gunmetal
1007350	578,-	736,-

Colours



-  Chrome (02) with Toughened safety glass shelf (ESG) white
-  Brushed gunmetal (280) with Toughened safety glass shelf (ESG) black

- AquaXPro surface-mounted shower thermostat with 38 °C locking
- AquaXPro shower rail with height adjustable holder
- AquaXPro designer hand shower with three spray modes (Rain, SoftRain, Massage)
- Shower hose 1.5 m with anti-twist protection on both sides

**COMPLETE-SET 1.40
AQUAXPRO**

Article no.	Chrome	Brushed gunmetal
1007400	548,-	681,-

Colours



-  Chrome (02) with Toughened safety glass shelf (ESG) white
-  Brushed gunmetal (280) with Toughened safety glass shelf (ESG) black

- AquaXPro surface-mounted bath thermostat with 38 °C locking
- AquaXPro designer hand shower with three spray modes (Rain, SoftRain, Massage) and hand shower holder
- Shower hose 1.5 m with anti-twist protection on both sides

**COMPLETE-SET 1.45
AQUAXPRO**

Article no.	Chrome	Brushed gunmetal
1007450	640,-	800,-

Colours

-  Chrome (02) with Toughened safety glass shelf (ESG) white
-  Brushed gunmetal (280) with Toughened safety glass shelf (ESG) black

- AquaXPro surface-mounted bath thermostat with 38 °C locking
- AquaXPro shower rail with height adjustable holder
- AquaXPro designer hand shower with three spray modes (Rain, SoftRain, Massage)
- Shower hose 1.5 m with anti-twist protection on both sides



Complete-set 1.35 AquaXPro
Brushed gunmetal (280) with
Toughened safety glass shelf and front (ESG) black

The dimension depends on the position of the S-connections and may vary slightly due to the manufacturing process. All dimensions are subject to a tolerance of ± 5 mm.





CLASSIC SHOWER-SET

Article no.	Chrome	Black matt	Stainless steel finish
1008500	579,-	669,-	669,-

CLASSIC SHOWER-SET



Article no.	Brushed gunmetal	Brushed gold	Brushed copper
1008528	759,-	759,-	759,-

Colours

-  Chrome (02)
-  Black matt (68)
-  Stainless steel finish (90)

- Safety thermostat with 38 °C locking and integrated diverter
- Cold water fail-safe device
- Incl. backflow preventer
- Flat overhead shower, ø 250 × 8 mm, swivelling and height adjustable
- Designer hand shower with three spray types (Rain, SoftRain, Massage) and height adjustable holder
- Anti scale nozzles
- Shower hose 1.5 m with anti-twist protection on both sides
- Incl. mounting accessories

Colours

-  Brushed gunmetal (280)
-  Brushed gold (281)
-  Brushed copper (282)

- Safety thermostat with 38 °C locking and integrated diverter
- Cold water fail-safe device
- Incl. backflow preventer
- Flat overhead shower, ø 250 × 8 mm, swivelling and height adjustable
- Designer hand shower with three spray types (Rain, SoftRain, Massage) and height adjustable holder
- Anti scale nozzles
- Shower hose 1.5 m with anti-twist protection on both sides
- Incl. mounting accessories

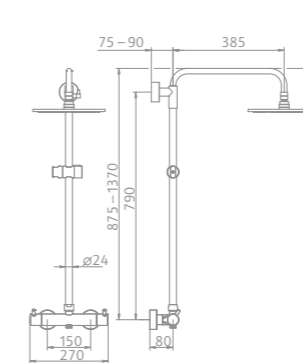

SHOWER-SET RS 200 THERMOSTAT

Article no.	Chrome
1006600	816,-

Colour

-  Chrome (02)

- Safety thermostat with 38 °C locking and integrated diverter
- Cold water fail-safe device
- Incl. backflow preventer
- Flat overhead shower Rund, ø 250 × 8 mm, swivelling and height adjustable
- Designer hand shower Rund with three spray types (Rain, SoftRain, Massage) and height adjustable holder
- Anti scale nozzles
- Shower hose 1.5 m, silver with anti-twist protection on both sides
- Incl. mounting accessories

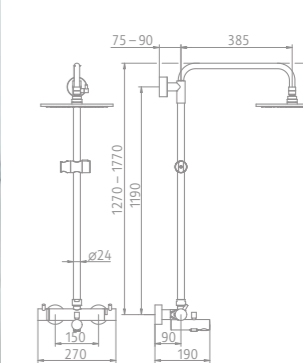

RS 200 THERMOSTAT FOR BATHTUB

Article no.	Chrome
1006700	932,-

Colour

-  Chrome (02)

- Safety bath thermostat with 38 °C locking and integrated diverter
- Cold water fail-safe device
- Incl. backflow preventer
- Flat overhead shower Rund, ø 250 × 8 mm, swivelling and height adjustable
- Designer hand shower Rund with three spray types (Rain, SoftRain, Massage) and height adjustable holder
- Anti scale nozzles
- Shower hose 1.5 m, silver with anti-twist protection on both sides
- Incl. mounting accessories

The dimension depends on the position of the S-connections and may vary slightly due to the manufacturing process. All dimensions are subject to a tolerance of ± 5 mm.

Extras for the shower

SHOWER ACCESSORIES

Sophisticated accessories in a modern design make daily showering pleasant and safe.





Comfort and safety in the shower area

FOLDING SHOWER SEAT ATELIER

The modern folding shower seat Atelier was developed for greater safety when showering. The generous seat surface in black matt ensures pleasant seating comfort and can be folded up to save space after showering.

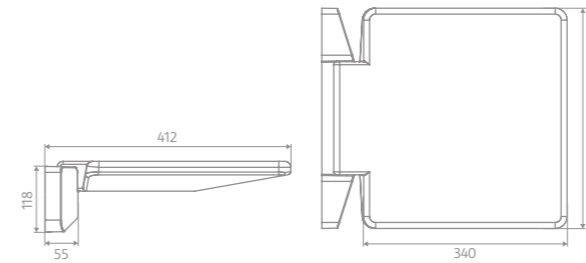

FOLDING SHOWER SEAT ATELIER

Artikel no.	Chrome
1500023	318,-

Colour

Chrome (02) with seat in black matt

- Projection 412 mm
- Seat made of hygienic PU foam
- Load capacity up to 150 kg
- Incl. mounting accessories

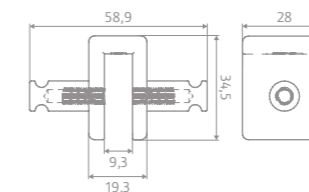
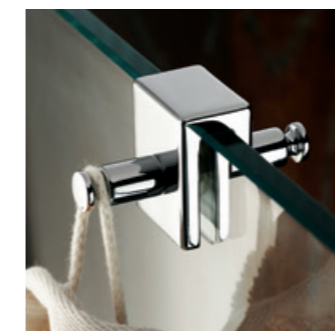

DOUBLE ROBE HOOK

Artikel no.	Chrome
100024	31,-

Colour

Chrome (02)

- All-metal
- Concealed fixing
- Suitable for 5 – 8 mm Toughened safety glass (ESG) panes

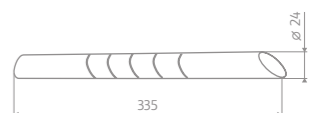

UNIVERSAL FOOTREST

Artikel no.	Chrome
100025	46,-

Colour

Chrome (02)

- All-metal
- 5 × anti-slip rings for more slip resistance

All dimensions are subject to a tolerance of ± 5 mm.



Warmth for well-being

DESIGNER RADIATORS

Clear shapes and colours for a timeless interior design as well as additional functions for more comfort – this is what the designer radiator range offers for bathrooms and living rooms.



DESIGNER RADIATORS | Warmth for well-being



Warm and dry

The modern design and high-quality towel rails create functional space for drying and warming hand and shower towels.



Discreet or striking

On request, each designer radiator is available in numerous other colours in addition to the standard colours. A special highlight: the finely textured surface of the colours sandstone, pearl grey and graphite black.



Flexible

In addition to many model dimensions, the extensive range of valve sets offers maximum flexibility. Variable screw inserts allow the thermostatic head and the "flow" to be rotated so that they can be used on the left or right.



Functional

Practical accessories for connecting and operating modern radiators: The connection fittings that can be used on both sides for the centre connection and the heating element 4 with remote control for electrical operation.



DESIGNER RADIATORS | Warmth for well-being

High-gloss, matt or finely textured:

The colour world of designer radiators shines in the most beautiful shades, sets accents and shows the radiator as a decorative living element – according to individual wishes. Coordinated with the latest colour trends, the selected range of colours is harmonious, fresh, timeless, discreet, decorative and striking.

Standard colour



White (04)

Special colours



Bahama beige (05)



Manhattan grey (08)



Pergamon (25)



Anthracite (57)



Copper (60)



Black matt (68)



White matt (70)



Silver (88)

Textured colours



Sandstone (172)
finely textured



Graphite black (173)
finely textured



Pearl grey (174)
finely textured



Further RAL colours
on request

COLOUR WORLD OF DESIGNER RADIATORS



SEMPRIO

The timeless, modern radiator

Dimension in mm (W x H)	Rec. heating element in watts	Heat output in watts (EN 442) 75/65/20	Artikel no.	White	Graphite black	Special colours
600 x 1.380	600	689	8406138	969,-	1.158,-	1.385,-
600 x 1.520	900	761	8406152	1.046,-	1.254,-	1.505,-
600 x 1.800	900	905	8406180	1.169,-	1.397,-	1.681,-

Maximum operating pressure 5 bar. Convert watts into BTU x 3,41.



IMAGE

The modern frame

Dimension in mm (W x H)	Rec. heating element in watts	Heat output in watts (EN 442) 75/65/20	Artikel no.	White	Graphite black	Special colours
600 x 1.200	600	655	8616120	583,-	701,-	839,-
600 x 1.720	900	892	8616172	717,-	860,-	1.033,-

Anti corrosion coating

+ 188,-

Maximum operating pressure 5 bar. Convert watts into BTU x 3,41.



DESIGNER RADIATORS | Warmth for well-being

DESIGNER RADIATORS

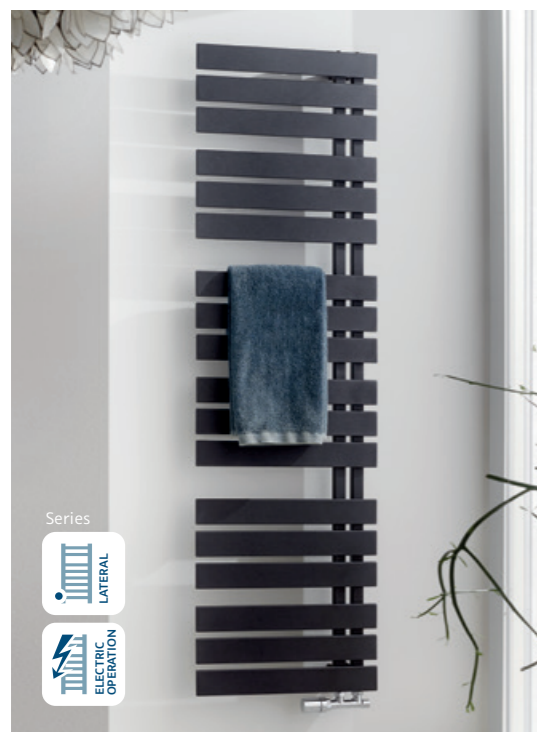

YENGA

The honoured

Radiator can be rotated overhead

Dimension in mm (W x H)	Rec. heating element in watts	Heat output in watts (EN 442) 75/65/20	Artikel no.	White	Graphite black	Special colours
500 x 1.186	600	455	8750120	720,-	784,-	939,-
500 x 1.824	900	638	8750180	995,-	1.144,-	1.462,-
600 x 1.186	600	528	8760120	741,-	826,-	1.016,-
600 x 1.824	900	740	8760180	1.059,-	1.209,-	1.483,-

Maximum operating pressure 4 bar. Convert watts into BTU x 3,41.



YENGA ROOM DIVIDER

The decorative towel dryer

Radiator can be rotated overhead

Dimension in mm (W x H)	Rec. heating element in watts	Heat output in watts (EN 442) 75/65/20	Artikel no.	White	Graphite black	Special colours
600 x 1.824	900	740	8760180-R	1.268,-	1.522,-	1.829,-

Mixed and electric operation not possible.
Maximum operating pressure 4 bar. Convert watts into BTU x 3,41.



YENGA LIGHT

The delicate

Radiator can be rotated overhead

Dimension in mm (W x H)	Rec. heating element in watts	Heat output in watts (EN 442) 75/65/20	Artikel no.	White	Graphite black	Special colours
600 x 1.150	600	585	8960120	614,-	734,-	840,-
600 x 1.540	600	713	8960150	713,-	875,-	1.024,-
600 x 1.735	900	816	8960180	848,-	1.017,-	1.207,-

Maximum operating pressure 4 bar. Convert watts into BTU x 3,41.



YENGA PLUS

The eye-catcher

Radiator can be rotated overhead

Dimension in mm (W x H)	Heat output in watts (EN 442) 75/65/20	Artikel no.	White	Graphite black	Special colours
600 x 1.214	706	8860120	946,-	1.136,-	1.365,-
600 x 1.742	992	8860180	1.267,-	1.521,-	1.824,-

Mixed and electric operation not possible.
Maximum operating pressure 4 bar. Convert watts into BTU x 3,41.



Connection and thermostatic fitting not included in the scope of delivery. The connection sets can be found from page 138 onwards.
Subject to design and model changes. Technical specifications without guarantee. All dimensions are subject to a tolerance of ± 2 mm.



ATELIER LINE

The super flat

Dimension in mm (W x H)	Heat output in watts (EN 442) 75 65 20	Artikel no.	White	Graphite black	Special colours
456 x 1.806	771	8744180	851,-	1.022,-	1.225,-
608 x 1.806	1.027	8746180	1.038,-	1.246,-	1.495,-

Mixed and electric operation not possible.
Maximum operating pressure 5 bar.

Optional accessories

Closed towel rail	Artikel no.	White	Chrome
Width 510 mm	860001	129,-	129,-
Width 650 mm	860001	137,-	137,-

Half open towel rail	Artikel no.	White	Chrome
Width 290 mm	860004	-	111,-
Width 430 mm	860004	-	129,-
Width 550 mm	860004	-	152,-

Please indicate desired option. Convert watts into BTU x 3,41.



ATELIER HIGHLINE

The highlight

Dimension in mm (W x H)	Rec. heating element in watts	Heat output in watts (EN 442) 75 65 20	Artikel no.	White	Graphite black	Special colours
608 x 1.806	900	665	8776186	932,-	1.119,-	1.339,-

Maximum operating pressure 10 bar. Convert watts into BTU x 3,41.



LINE PLUS

A real all-rounder

Dimension in mm (W x H)	Rec. heating element in watts	Heat output in watts (EN 442) 75 65 20	Artikel no.	White	Graphite black / black matt	Special colours
500 x 1.775	900	938	8085178	494,-	592,-	710,-
600 x 1.215	600	753	8086122	400,-	476,-	574,-
600 x 1.775	900	1.099	8086178	520,-	622,-	746,-

Anti corrosion coating

+ 188,-

The protruding towel rails are not completely flushed, so they only heat up slightly.
Maximum operating pressure 10 bar.
Convert watts into BTU x 3,41.



LINE PRO

The classic

Dimension in mm (W x H)	Rec. heating element in watts	Heat output in watts (EN 442) 75 65 20	Artikel no.	White	Graphite black / black matt	Special colours
600 x 1.215	600	711	8096122	441,-	530,-	637,-
600 x 1.775	900	1.032	8096178	486,-	583,-	699,-

Anti corrosion coating

+ 188,-

Maximum operating pressure 10 bar. Convert watts into BTU x 3,41.



Connection and thermostatic fitting not included in the scope of delivery. The connection sets can be found from page 138 onwards.
Subject to design and model changes. Technical specifications without guarantee. All dimensions are subject to a tolerance of ± 2 mm.

DESIGNER RADIATORS | Warmth for well-being

DESIGNER RADIATORS



Series



Optional



LINE

The proven all-rounder

Also available in customised sizes

Dimension in mm (W x H)	Rec. heating element in watts	Heat output in watts (EN 442) 75/65/20	Artikel no.	White	Special colours
400 x 1.215	300	483	804122	238,-	325,-
400 x 1.775	900	701	804178	287,-	415,-
500 x 775	300	388	805078	229,-	283,-
500 x 1.215	600	598	805122	246,-	331,-
500 x 1.775	900	867	805178	291,-	417,-
600 x 775	300	461	800078	234,-	298,-
600 x 1.215	600	711	800122	281,-	401,-
600 x 1.575	600	916	800158	293,-	421,-
600 x 1.775	900	1.032	800178	320,-	459,-
750 x 1.215	600	879	807122	308,-	423,-
750 x 1.775	900	1.276	807178	358,-	512,-
Made to measure			800555	608,-	873,-

Anti corrosion coating + 188,-

Surcharge for centre connection + 33,-

Maximum operating pressure 10 bar. Convert watts into BTU x 3,41.

LINE TWO

The double-row towel warmer

Dimension in mm (W x H)	Heat output in watts (EN 442) 75/65/20	Artikel no.	White	Graphite black	Special colours
600 x 1.230	986	8216123	615,-	738,-	885,-
600 x 1.770	1.210	8216177	774,-	930,-	1.117,-

Anti corrosion coating + 188,-

Mixed and electric operation not possible.
Maximum operating pressure 5 bar. Convert watts into BTU x 3,41.

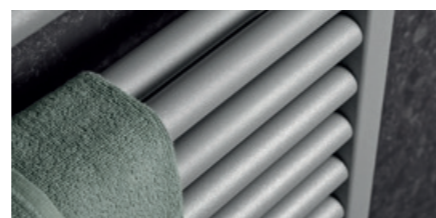

Series



Optional



Connection sets for a perfect connection

For optimum connection of the designer radiators to the central heating system, the modern range also offers suitable connection fittings for centre and side connections. Tailored to the different connection types and practical requirements, the sets have high-quality thermostat controllers with graduated temperature limitation.



Possible variations

Centre connection

- Compact valve
- Angle valve set
- Straight valve set

Side connection

- Angle valve set
- Straight valve set
- Angle corner valve set

All radiator valves are only suitable for two-pipe heating systems.



Also available in black matt

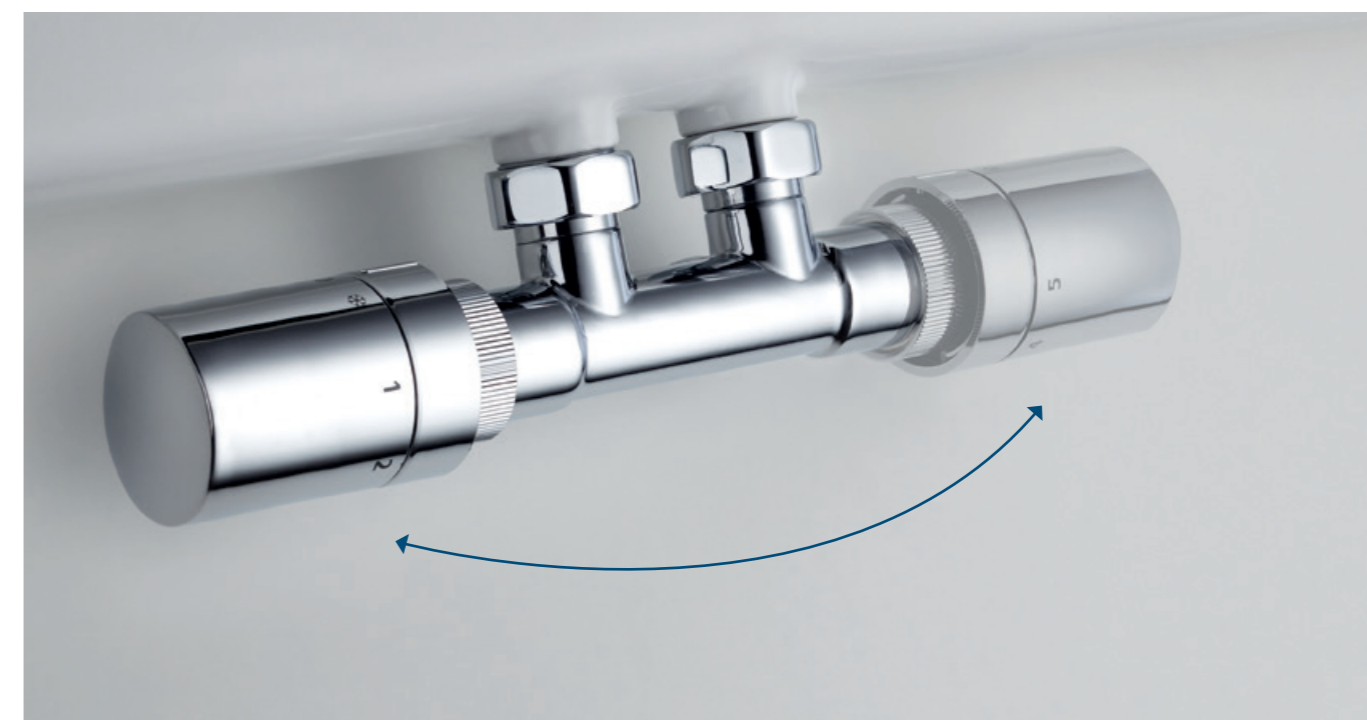

Flexible centre connection fittings

Two centre connection fittings offer increased flexibility during installation. Variable screw inserts allow the thermostatic head and the "flow" to be rotated so that they can be used on the left or right.

Connection and thermostatic fitting not included in the scope of delivery. The connection sets can be found from page 138 onwards. Subject to design and model changes. Technical specifications without guarantee. All dimensions are subject to a tolerance of ± 2 mm.

CENTRE CONNECTION WALL / CORNER VALVE SET

Consisting of fitting and thermostatic head (valve can be preset, thermostatic head can be limited), can be installed on both sides (change flow / return), integrated return screw connection (can be shut off).

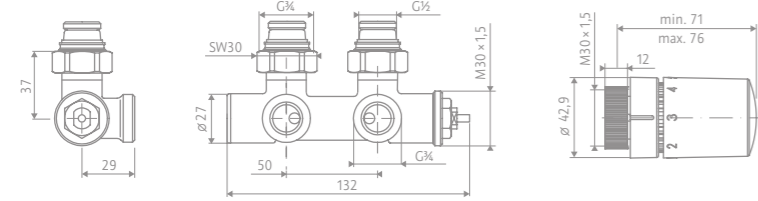

Article no.	Chrome	Black matt
890829	139,-	166,-

Please indicate desired colour.

All HSK radiator valves are only suitable for two-pipe heating systems.

CENTRE CONNECTION FLOOR / VALVE SET PASS-THROUGH

Consisting of fitting and thermostatic head (valve can be preset, thermostatic head can be limited), can be installed on both sides (change flow / return), integrated return screw connection (can be shut off).

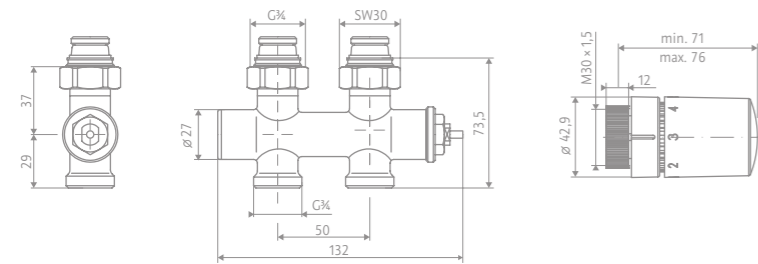

Article no.	Chrome	Black matt
890832	139,-	166,-

Please indicate desired colour.

All HSK radiator valves are only suitable for two-pipe heating systems.

MIXED MODE SET

Consisting of flow valve angle-corner, with thermostatic head (valve can be preset, thermostatic head can be limited) and special return valve for heating element (can be shut off).

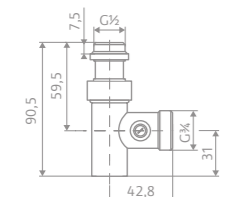

Special return valve

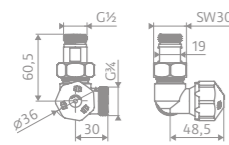

Flow valve, version left

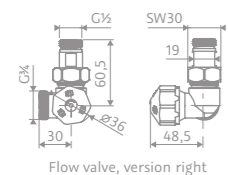

Flow valve, version right

Version left



890836	166,-
---------------	-------

Version right

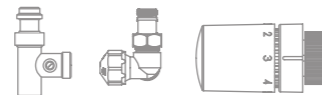

890837	166,-
---------------	-------

The mixed operation set can only be combined with heating element 1 and heating element 2.

All HSK radiator valves are only suitable for two-pipe heating systems.

COMPACT VENTIL



Consisting of fitting with design cover and thermostatic head (valve can be preset, thermostatic head can be limited), can be used as a corner or straight-through variant, flow side can be exchanged, integrated return screw connection (can be shut off).

Dimensions with design panel

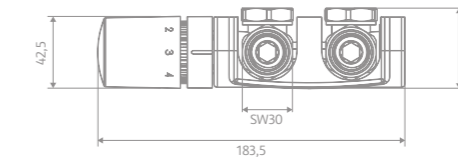

Dimensions without design panel

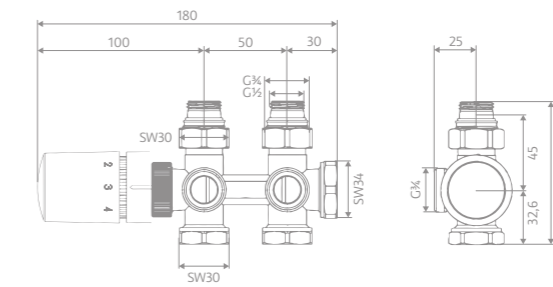

Article no.	Chrome	White	Black matt
890840	139,-	139,-	139,-

Please indicate desired colour.

All HSK radiator valves are only suitable for two-pipe heating systems.

COMPRESSION FITTING

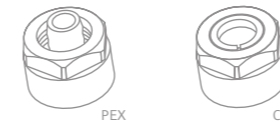

Set for copper pipes (2 pieces 15 x 1 Cu)

Article no.	Chrome	Black matt
890011	16,-	20,-

Set for PEX pipes (2 pieces 16 x 2 Pex)

890012	18,-	22,-
---------------	------	------

Please indicate desired colour.

Standard compression fitting for copper or PEX pipes. Ideally matched to HSK standard fittings (G3/4 Euro cone).



Electric operation



Mixed operation

(Can only be combined with heating element 1 and heating element 2)

Designer radiators in electric and mixed operation

In addition to connection to the central heating system, many designer radiators offer the option of flexible and localised heating – either in pure electric mode or in so-called mixed mode.

All that is required for electrical operation is a power connection via the socket and a heating element. We recommend filling the radiator with a special water-glycol mixture.

In mixed mode, the radiator is connected to the central heating system and the immersion heater. This combines the advantages of both operating modes.

The Semprio, Yenga, Yenga Light, Yenga room divider, Line Plus, Line, Line Pro, Image and Atelier Highline ranges are suitable for electric and mixed operation.

GLYCOL



For purely electric operation
Bottle capacity 1.5 litres

Fill the radiator 95 % full with a water-glycol mixture.
The glycol content must not make up more than 15 % of the total filling volume.

Article no.	Price
890002	29,-

HEATING ROD 1*



Protection class IP55
Cable length 1.20 m, colour white

In accordance with the Ecodesign Directive, we would like to point out that this product is intended exclusively for towel radiators. This product is not suitable as a main heating appliance.

Power in watts	Article no.	White
300	890300	115,-
600	890600	128,-
900	890900	136,-

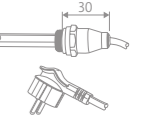

HEATING ROD 2*



Protection class IPX4, with power regulation
Cable length 1.20 m, colour white

In accordance with the Ecodesign Directive, we would like to point out that this product is intended exclusively for towel radiators. This product is not suitable as a main heating appliance.

Power in watts	Article no.	White
300	891300	181,-
600	891600	192,-
900	891900	220,-

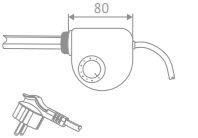

HEATING ROD 3 LED*



Protection class IP44, LED technology, timer function (2/4/6/8 h), frost guard, 4 heating levels, overheating protection, coiled cable length 0.66 m (extendable to 1.5 m)

Available in white and silver.

In accordance with the Ecodesign Directive, we would like to point out that this product is intended exclusively for towel radiators. This product is not suitable as a main heating appliance.

The heating element cannot be combined with the mixed mode set.
The combination with a timer is not possible for technical reasons.

Power in watts	Article no.	White	Silver
300	892300	265,-	278,-
600	892600	288,-	300,-
900	892900	310,-	323,-

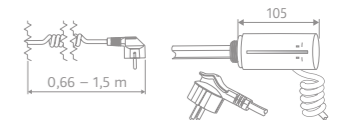

HEATING ROD 4 WITH REMOTE CONTROL*



Protection class heating rod IPX5, remote control IP30
Intelligent heating element with adjustable daily/weekly programme, frost guard, coiled cable length 0.5 m (extendable to 1.5 m)

Heating rod available in white and silver, remote control in white.

The heating element cannot be combined with the mixed mode set.
The heating element and remote control must be located in the same room.
The remote control is battery-operated.

Power in watts	Article no.	White	Silver	Black
300	894300	310,-	354,-	354,-
600	894600	332,-	377,-	377,-
800	894900	354,-	399,-	399,-

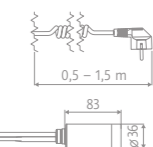

All heating rods come with a two-pin plug. Please purchase UK adapter separately.
For technical reasons, the heating of the water-glycol filling causes operating noises during electrical operation.



Creative wall cladding

RENODECO

Set accents and conjure up a whole new atmosphere in your bathroom.

RenoDeco, the seamless wall cladding for an unusual bathroom design in partial renovations and new builds.



RENODECO | Creative wall cladding



High-quality

RenoDeco is a hard-wearing, scratch-resistant aluminium composite material with an easy-care surface. This wall covering is therefore ideal for wet areas – in the shower or behind the washbasin and WC.

Seamless

Where reliability and easy maintenance are important, RenoDeco is the right choice. The high-quality, waterproof material enables large areas of entire wall surfaces or individual functional areas to be covered – without any joints.

Decorative

Exclusive high-gloss surfaces bring brilliance and depth to the bathroom, while high-quality textured surfaces offer characteristic embossing of natural materials. The silk-matt surfaces achieve even more exclusivity with their elegant, matt look and slightly silky shimmer.

Customised

In addition to the extensive decor selection, you can also bring your own motifs and memories into your bathroom. With the customisable RenoDeco photo printing, there are no limits to the design.



Reno Deco wall cladding Larch, natural light (538).
Shower cubicle see page 44.

RENODECO

The finishing touch

Silk-matt, high-gloss, textured

RenoDeco not only impresses with its individual, fresh look, but also with its hygienic properties. The water- and scratch-resistant material and the high-quality surface finish also prevent dirt, mould and limescale from settling. Depending on the style and furnishings, you can choose between the three surfaces. Alternatively, they can be combined just as beautifully and effectively.

7 plus points that make the difference!

HIGH-GRADE, RUGGED LAYERED STRUCTURE THANKS TO SURFACE FINISH

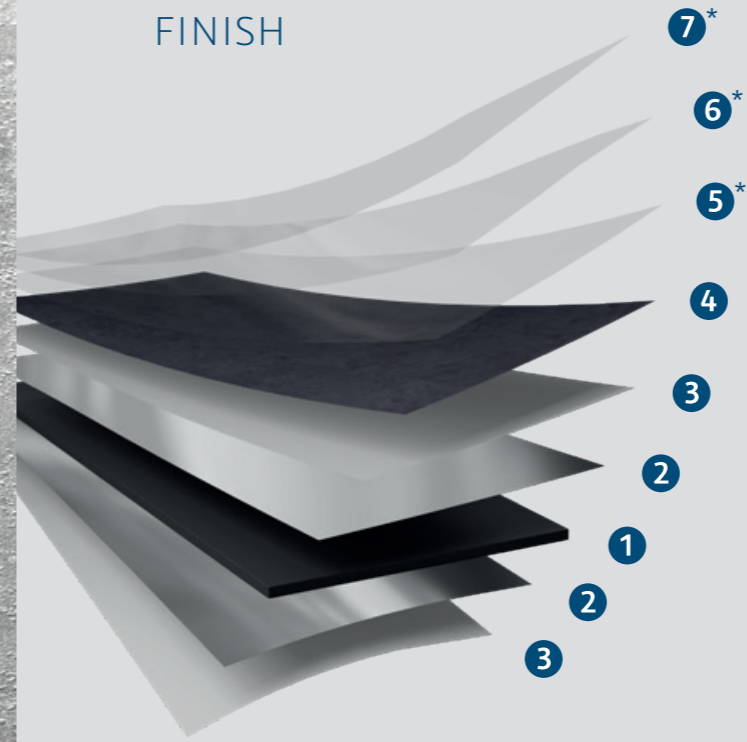

7. Surface finish (*only with textured decors)

Offers striking embossing of natural materials for a genuine tactile experience

6. Top coating

Hard-wearing top paint coating for a perfect surface finish

*High-gloss and silk-matt finishes are composed of two highly abrasion-resistant paint layers

5. Basecoat

Highly abrasion-resistant paint coating

*High-gloss and silk-matt finishes are composed of three highly abrasion-resistant paint layers

4. Digital print

Six-colour printing for motives that tell a story

3. Primer

The job of the primer is to maximise the colour display and enable optimum adhesion.

2. Aluminium cover layer

HSK uses a high-quality, 0.3 mm aluminium cover layer instead of the commonly used 0.15 - 0.2 mm aluminium cover layers

1. Panel core

The core is made of premium LDPE polyethylene

Benefits

- Various designs with textured, high-gloss or silk-matt surfaces
- Three panel formats available to provide seamless cladding of larger wall surfaces in the blink of an eye
- Robust, classy surface finish for a long life
- 3 mm material thickness – requires very little additional wall texture
- Ample decor range with stone, wood, concrete, fine plaster, metal, tile, and uni-decors, plus custom prints with custom photos or motives out of the HSK image database
- Straightforward, easy to clean
- Can be worked and installed directly on site with standard tools

Properties

- Hygienically seamless, easy maintenance, water-resistant
- Durable, resistant and scratch-proof
- Colour-stable, food-safe and temperature-resistant up to +80°C
- Lightweight: 3.8 kg/m²
- Fire category B2 according to DIN 4102-1
- A+ classification according to French regulations for VOC emissions (emission-free)
- Perfect imitation of natural materials (stone, wood, etc.) thanks to tactile, textured surfaces
- Shaped design for manual edging of creative wall cladding with textured surface

Perfect hygiene thanks to the lotus effect

Thanks to the refined surfaces of the RenoDeco creative wall cladding, there is a strong beading behaviour. Water runs off the silk-matt and high-gloss surfaces almost without leaving any residue, while only drops of water remain on the hydrophobic surface of the textured paint. This guarantees easy maintenance of the wall panelling.



Video
Perfect hygiene

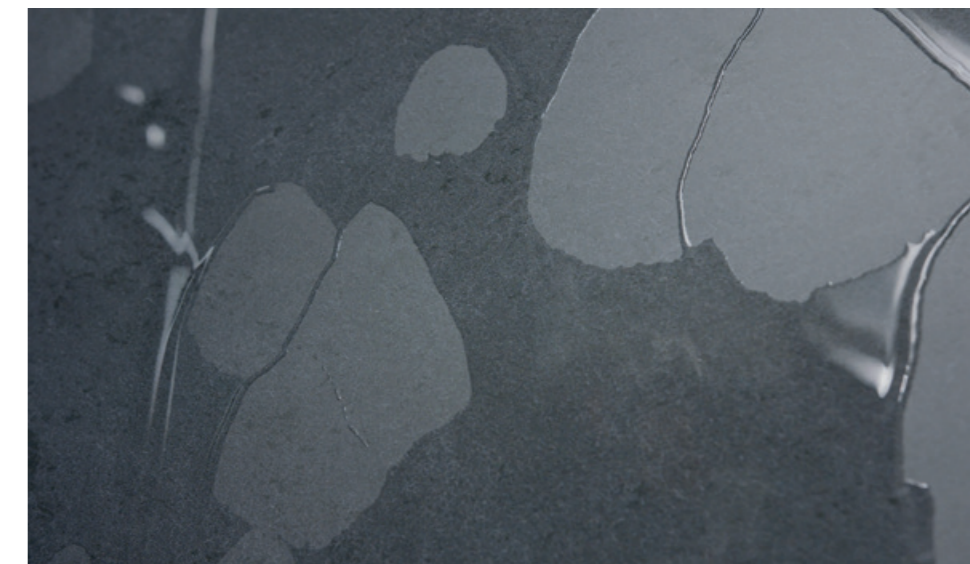



You can find the RenoDeco configurator online at: individual.renodeco.de

Versatile designs

Velvety silk-matt, elegant high-gloss, strikingly textured

Exclusive RenoDeco high-gloss decors bring brilliance to the individual dream bathroom. The multi-layered lacquer texture ensures a sophisticated lustre with depth effect. The high-quality textured surfaces are almost indistinguishable from natural materials. The silk-matt surfaces, which are velvety soft to the touch and offer a high-quality, matt look with a silky shimmer, add even more exclusivity to the bathroom. The customised print is highly expressive – velvety silk-matt, elegant high-gloss or strikingly textured.

Aluminium composite panel	Dimensions in cm	Article no.	Price
High-gloss surface	100 × 210*	942000	359,-
	100 × 255	940000	399,-
	150 × 255	940200	598,-
High-gloss surface with photo printing, individual	100 × 255	940400	596,-
	150 × 255	940600	814,-
Uni high-gloss surface	100 × 210*	942000	359,-
	100 × 255	940000	399,-
	150 × 255	940200	598,-

HIGH-GLOSS

Fine stone decors

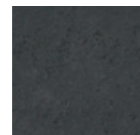

Fine stone, graphite grey (701)



Fine stone, ash grey (702)

Sandstone decors

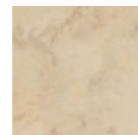

Sandstone, terra beige (704)

Natural stone decors



Marble, white grey (703)



Marble, classico white (773)



Marble, carrara white (783)

Uni decors



Uni, arctic white (761)



Uni, crema beige (769)

Individual printing



Photo printing, individual

* Only available for selected decors





You can find the RenoDeco configurator online at: individual.renodeco.de



Exposed concrete, cemento grey (881)



AFTER

Exposed concrete, cemento grey (881) and Uni, crema beige high-gloss (769)

Aluminium composite panel

	Dimensions in cm	Article no.	Price
Silk-matt surface	100 × 210*	942000	359,-
	100 × 255	940000	399,-
	150 × 255	940200	598,-
Silk-matt surface with photo printing, individual	100 × 255	940400	596,-
	150 × 255	940600	814,-
Uni silk-matt surface	100 × 210*	942000	359,-
	100 × 255	940000	399,-
	150 × 255	940200	598,-

SILK-MATT

Fine stone decors

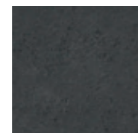

Fine stone, graphite grey (801)



Fine stone, ash grey (802)



Fine stone, vertino beige (851)



Exposed concrete, cemento grey (881)

Terrazzo decor



Terrazzo, anthracite (843)

Natural stone decors

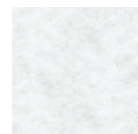

Marble, white grey (803)



Marble, carrara black (829)



Marble, carrara white (883)

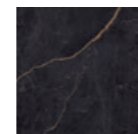

Marble, copper anthracite (841)

Uni decors



Uni, arctic white (861)



Uni, crema beige (869)

Natural stone decors



Marble, jura-greige (844)



Marble, perlato anthracite (842)



Natural stone, calco beige (852)



Marble, pura grey (880)

Individual printing



Photo printing, individual

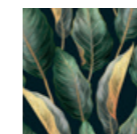

Tropical leaves, gold-green (850)



BEFORE

* Only available for selected decors



You can find the RenoDeco configurator online at: individual.renodeco.de

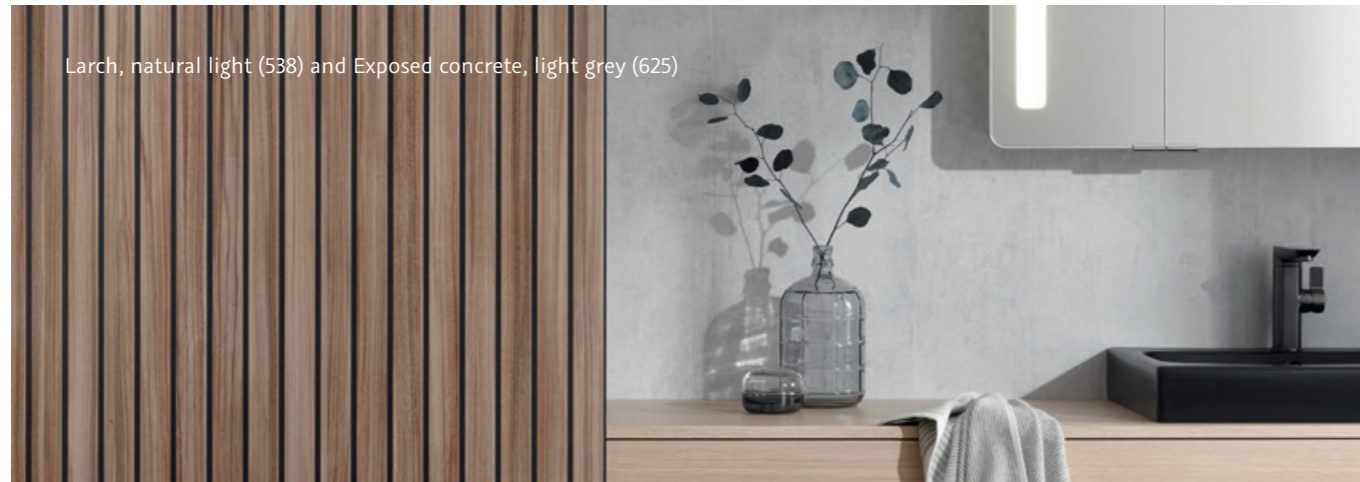

Aluminium composite panel

	Dimensions in cm	Article no.	Price
Textured surface	100 × 210*	942000	312,-
	100 × 255	940000	324,-
	150 × 255	940200	492,-
Textured surface with photo printing, individual	100 × 255	940400	531,-
	150 × 255	940600	703,-

TEXTURE

Fine stone decors



Fine stone, vertino beige (551)

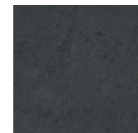

Fine stone, graphite grey (601)



Fine stone, ash grey (602)



Fine stone, stucco white (619)

Natural stone decors



Natural stone, slate grey (550)



Natural stone, calco beige (552)



Marble, white grey (603)

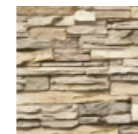

Natural stone, champagne (606)

Wood decor



Larch, natural light (538)



Wild oak, rustic (543)

Plaster decor



Fine plaster, greige (540)

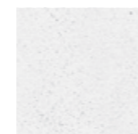

Fine plaster, white (659)

Sandstone decor

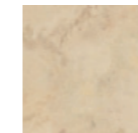

Sandstone, terra beige (604)

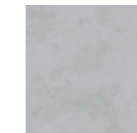

Sandstone, terra grey (615)

Concrete decor

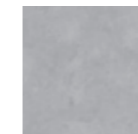

Exposed concrete, cemento grey (537)



Exposed concrete, light grey (625)

Metal decor

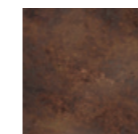

Metal, rust red (611)

Individual printing



Photo printing, individual



* Only available for selected decors



Corner profile outside flush-mounted, chrome finish



Flush end profile, black matt

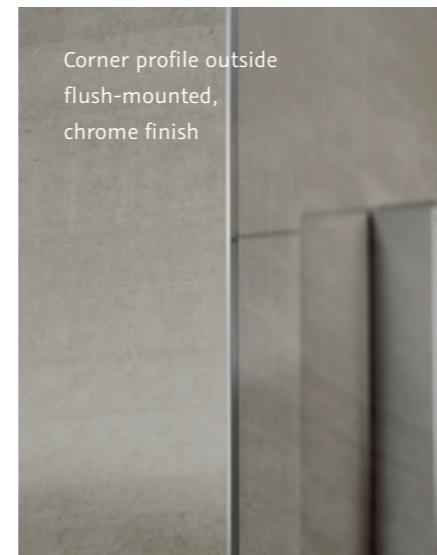

Corner profile outside flush-mounted, chrome finish



Corner profile inside, aluminium silver matt

Everything in order

Perfect connections with aluminium profiles

The RenoDeco creative wall cladding can be joined seamlessly and reliably using slim aluminium profiles – whether around corners or on the surface. The flush, angular or optionally rounded profile provides a neat panel finish. The 3D corner provides a professional finish for three surfaces on an external corner, as with a pre-wall installation.

Profile colours

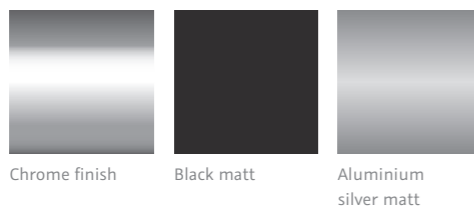

Chrome finish

Black matt

Aluminium silver matt

Profiles



Type of profile
Corner profile outside straight
ca. 22 × 22 mm

Length in cm	Article no.	Aluminium silver matt	Chrome finish	Black matt
255	930011	46,-	56,-	56,-
255	930012	46,-	56,-	56,-
255	930002	46,-	56,-	56,-
255	930003	46,-	56,-	56,-
255	930015	46,-	56,-	56,-
209	930110	80,-	-	-
254	930010	92,-	-	-
255	930004	46,-	56,-	56,-
255	930009	46,-	56,-	56,-



Corner profile outside flush-mounted
ca. 23 × 27 mm



Corner profile inside
ca. 23 × 23 mm



Connection profile
ca. 33 × 6 mm



Flush connection profile
ca. 45 × 5,2 mm



Invisible joint profile
ca. 80 × 2,5 mm



Straight end profile
ca. 17 × 6 mm



Flush end profile
ca. 23 × 5,2 mm

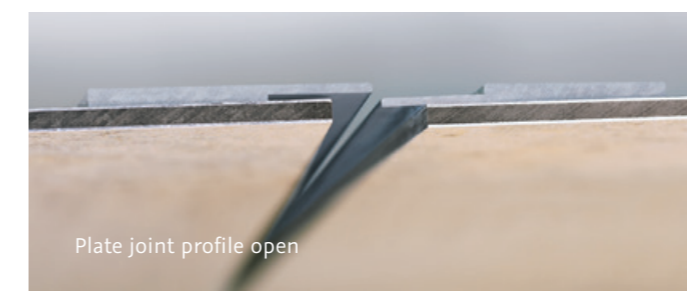

Plate joint profile open

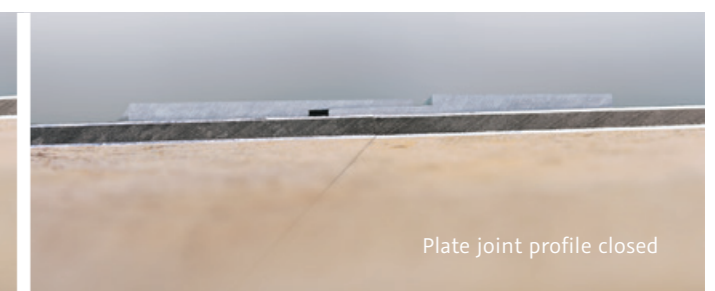

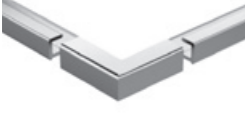
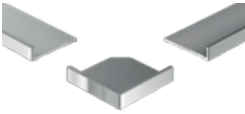



Plate joint profile closed

Profiles	Type of profile	Length in cm	Article no.	Aluminium silver matt	Chrome finish	Black matt
	3D corner outside straight For pre-wall installations (approx. 23 × 23 mm) To be combined with 3 × corner profile outside straight (Article no. 930011)	2.3 × 2.3	930014	16,-	16,-	16,-
	Outside corner straight approx. 18 × 18 mm To be combined with 2 × straight end profile (Article no. 930004)	1.8 × 1.8	930008	16,-	16,-	16,-
 <small>2D solution</small>	Outside corner flush approx. 27.5 × 27.5 mm To be combined with 2 × flush end profile (Article no. 930009) or 3 × corner profile outside flush-mounted (Article no. 930012) for the realisation of a 3D solution for pre-wall installations	2.75 × 2.75	930013	16,-	16,-	16,-
 <small>3D solution</small>						

Accessories

Mounting kit



Features

For gluing RenoDeco creative wall cladding

Set content

- Cartridge of transparent adhesive incl. tip
- 10 m PE adhesive tape, 40 × 2 mm
- 2 × shims
- Silicone wedges

Product information

- Quantity required for installation:
100 × 210 cm | 1 × mounting kit
100 × 255 cm | 1 × mounting kit
150 × 255 cm | 2 × mounting kit

Article no.

Price

930100 48,-

Silicone set

930150 211,-

Set content

- Box (PU) with 20 cartridges of installation silicone, 310 ml each
- Incl. silicone tips

1-component special glue



1-component special glue, set 1

940110 90,-

1-component special glue, set 2

940115 134,-

Set content

- Set 1: 4 × foil bags, incl. silicone tip (for battery press), spatula and wedges
Sufficient to bond one RenoDeco creative wall cladding each in 100 × 210 cm or 100 × 255 cm.
- Set 2: 6 × foil bags, incl. silicone tip (for battery press), spatula and wedges
Sufficient to bond one RenoDeco creative wall cladding in 150 × 255 cm.

Product information

- For surface bonding of RenoDeco creative wall cladding
- Ready to use in a film bag
- Ideal for portioning
- 580 ml container



Optionally available with silk-matt, high-gloss or textured surface

RenoDeco individual printing

There are no limits to your design ideas with RenoDeco

The extensive decor range picks up on current living trends and thus offers a wide range of options for giving the bathroom a modern, natural or imaginative touch. Only the integration of personal memories can be even more individual and original. The solution: RenoDeco allows you to add your own digital photo motifs to the wall. No matter which motif – there are no limits to your creativity. For example, bring the impressive rock formations of the Dolomites into your shower or immerse yourself in a lively underwater world with depth effect.

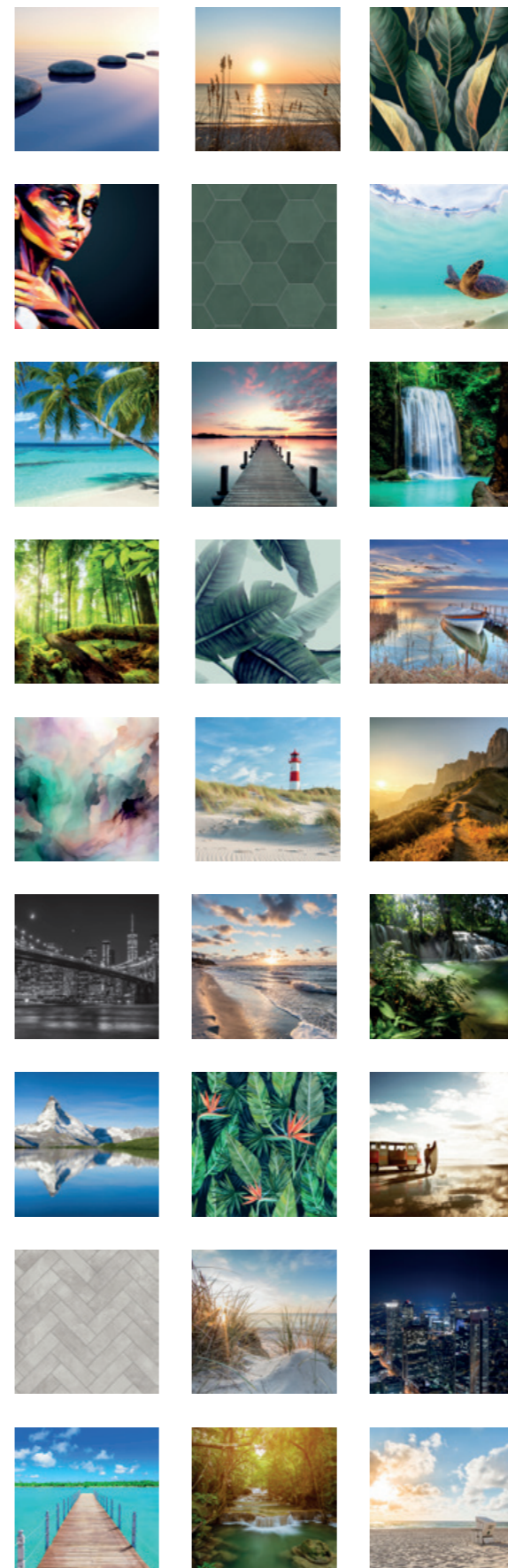

Many customised decors are available in the photo gallery and are updated on an ongoing basis.

CONFIGURE YOUR OWN BATHROOM LANDSCAPE

Quick and easy

Upload your personalised motif with the help of the easy-to-use configurator. In addition many great motifs in colour or black and white to choose from in the photo gallery. ready. Let yourself be inspired for your personal bathroom dream. You can find the RenoDeco configurator online at: individual.renodeco.de

Scan the QR code and be creative



HSK

BATHROOM EXPERTS

HSK Duschkabinenbau KG
Zum Hohlen Morgen 22
59939 Olsberg
Germany

Tel. +49 2962 97903-0
Fax +49 2962 6570
info@hsk-duschkabinenbau.de

Scott Bower
HSK UK and Ireland Business Manager
Mob. +44 079 61681501
Scott@hskshowerdoors.co.uk



RRP in £ ex VAT



Technical data without guarantee. Subject to changes. Version 06/2024. X10491

www.hsk.de/en/gb