

---

CREATING  
PERFECT  
HARMONY™

# HARMONY COLLECTIONS TECHNICAL

UK - NOVEMBER 2024



BROWSE OUR  
**WATERFALL**  
LOOKBOOK

ORO ETO ILI AYO

FLAIRSHOWERS.COM



SINCE  
1952

flair  
—

OVER **70** YEARS

Founded in County Cavan in 1952, Flair Showers have built up a trusted reputation as a specialist in the production of quality shower doors, wetrooms and bathscreens. Our reputation has stood the test of time, making us the oldest manufacturer of our kind in Ireland. We are proud to be a brand of choice for customers internationally.

With an unwavering commitment to customer care, Flair combine lifelong knowledge and expertise with advanced production techniques. We can accommodate a great variety of bathroom styles with an extensive product portfolio. Our mission is to inspire through meaningful designs that bring a new sense of enrichment to the bathroom and enjoyment to our customers. As you explore the Harmony Collections catalogue, we hope you are captivated by every detail.

**The perfect blend of function and form. Designed for life.**





## AWARD WINNING PRODUCT DESIGNS

Flair's unrelenting passion for innovation has achieved International recognition in the form of numerous design award accolades.

### **GOOD DESIGN AWARD® (CHICAGO)**

Founded in 1950 by architects Eero Saarinen, Charles and Ray Eames and Edgar Kaufmann, **GOOD DESIGN®** is the world's oldest Design Awards program. It is organised annually by The Chicago Athenaeum Museum of Architecture and Design. It recognises the work of manufacturers who have undertaken the design challenge to produce product of the most outstanding design globally.

### **RED DOT DESIGN AWARD (GERMANY)**

The **Red Dot** label is recognised as a warranty of design excellence. It is awarded to entrants who demonstrate an innovative spirit with product of the highest quality, form and function gaining this design awards honour.

### **iF DESIGN AWARD (GERMANY)**

The **iF DESIGN AWARD** recognises exceptionally well-designed products. Since 1953, an esteemed jury of International design experts have awarded this symbol to product that is user focused, ergonomic and efficient in its design.



# CONTENTS



06



48



88



126

---

GEMSTONE  
SHOWER TRAYS

205

---

SHOWER  
TRAYS

214

---

ANTI-SLIP  
SHOWER TRAYS

216

---

ULTRA SLIM  
SHOWER TRAYS

218



## DESIGN AWARDS

Flair are proud to have received three design accolades in recognition of the ORO shower door collection.

The **Good Design Award**, **RedDot Award**, and **iF Design Award** are seals of global design excellence and a testimony to our passion for product quality and innovation.



## PATENTED MAGNETIC GUIDE

The patented Magnetic Guide System is the first of the kind in the industry. It ensures the smoothest of motion for each sliding door as it glides along the bottom rail.



EXPLORE  
ORO

ORO

FRAMELESS &  
ULTRA FRAMELESS 8mm  
SHOWER ENCLOSURE  
COLLECTION

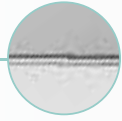

SILVER

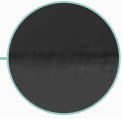

MATTE BLACK

# FINISHES

S - Silver  
B - Matte Black



# THE ORO<sup>®</sup> COLLECTION

## **ORO - the epitome of grace & beauty.**

With a graceful aesthetic, the award winning ORO collection is a union of design innovation and functional perfection. This signature collection sets the standard in frameless shower door design.

The hand crafted ORO door handles are one of a kind and distinctly individual. The patented magnetic guide system provides a smooth and effortless gliding action for each sliding door. Elegance shines through the curved profile and hinge detailing.

Each ORO detail is carefully considered to enhance your experience every day.



# IDEA CONCEPT PROTOTYPE ORO



## VISIONARY DETAILS



2 METRES HIGH



CONCEALED INTERIOR  
FIXATION POINTS



8mm TOUGHENED  
SAFETY GLASS TO EN12150



INNOVATIVE  
ULTRA CLEAR SEALS



CLEARVUE IS A HYDROPHOBIC  
GLASS COATING THAT RESISTS  
THE BUILD UP OF LIMESCALE AND  
GRIME ON THE GLASS SURFACE



SUITABLE FOR SHOWER  
TRAY OR WETROOM  
FLOOR INSTALLATION



UNIQUELY CRAFTED  
CHROME PLATED HANDLE



LIFETIME  
GUARANTEE

# THE ORO® COLLECTION

SILVER & BLACK OPTIONS

SLIDING  
DOOR

16

SLIDING DOOR  
WITH TWO  
INLINE PANELS

18

SLIDING  
QUADRANT  
DOOR

20

SLIDING OFFSET  
QUADRANT  
DOOR

22

HINGED  
QUADRANT  
DOOR

24

HINGED OFFSET  
QUADRANT  
DOOR

26

BIFOLD  
DOOR

28

HINGE  
DOOR

30

HINGE DOOR  
WITH  
INLINE PANEL

32

HINGE &  
INLINE DOOR

34

HINGE & INLINE  
DOOR WITH  
INLINE PANEL

36

## THE ORO® ULTRA FRAMELESS COLLECTION

BIFOLD DOOR /  
ULTRA FRAMELESS

38

HINGE DOOR /  
ULTRA FRAMELESS

40

HINGE & INLINE /  
ULTRA FRAMELESS

42

---

# VISIONARY INNOVATIONS

COUNTERSUNK INTERIOR HINGES  
WITH FLUSH TO GLASS FINISH



CURVED HINGE  
DETAILING



SIGNATURE  
HANDLE  
DESIGN



UNIQUELY CRAFTED  
BI-FOLD HANDLE



PATENTED MAGNETIC  
GUIDE SYSTEM



MINIMALIST BOTTOM  
DOOR GUIDE

---

# FUNCTIONAL INNOVATIONS

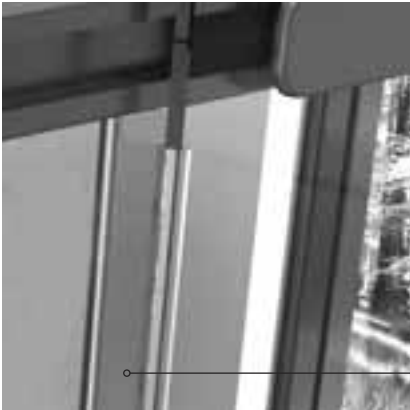

ULTRA  
CLEAR  
DOOR  
SEALS

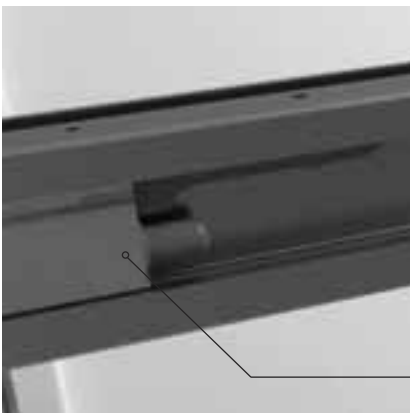

CUSHION  
CLOSE  
DAMPENER  
SYSTEM



CURVED  
RADIUS  
DETAILING  
THROUGHOUT







SLIDING DOOR (LEFT HAND)  
WITH SEMI FRAMED SIDE PANEL - SILVER

*Note: Sliding Door may also be installed to close onto Side Panel, please check door handing before ordering.*



SLIDING DOOR  
(LEFT HAND) IN ALCOVE -  
MATTE BLACK



# SLIDING DOOR

SILVER

MATTE BLACK

A delightful choice, the ORO Sliding Door glides along with smooth perfection. The patented magnetic guide on the bottom of the door is the first of its kind on the market. 8mm toughened safety glass offers a tactile feeling of strength and quality.

The **floating top rail design** is a signature characteristic of the ORO range. With a **seamless interior cover cap**, the top rail also cleverly conceals the roller system. The finishing touch is the **unique handle design** – beautifully formed and a pleasure to use.

## DOOR SIZE OPTIONS

PRODUCT SIZE (mm)	ADJUSTMENT SIZE		ACCESS (mm)	CODE	CODE
	MIN (mm)	MAX (mm)		SILVER	MATTE BLACK
1100 - Left Hand	1060	1100	480	OROSA110LSC	–
1100 - Right Hand	1060	1100	480	OROSA110RSC	–
1200 - Left Hand	1160	1200	580	OROSA120LSC	OROSA120LBC
1200 - Right Hand	1160	1200	580	OROSA120RSC	OROSA120RBC
1400 - Left Hand	1360	1400	580	OROSA140LSC	OROSA140LBC
1400 - Right Hand	1360	1400	580	OROSA140RSC	OROSA140RBC
1500 - Left Hand	1460	1500	580	OROSA150LSC	OROSA150LBC
1500 - Right Hand	1460	1500	580	OROSA150RSC	OROSA150RBC
1600 - Left Hand	1560	1600	580	OROSA160LSC	–
1600 - Right Hand	1560	1600	580	OROSA160RSC	–

## SEMI FRAMED SIDE PANEL OPTIONS (INCLUDES CORNER PROFILE)

PRODUCT SIZE (mm)	ADJUSTMENT SIZE		CODE	CODE
	MIN (mm)	MAX (mm)	SILVER	MATTE BLACK
700	670	690	OROSP70SC	OROSP70BC
760	730	750	OROSP76SC	OROSP76BC
800	770	790	OROSP80SC	OROSP80BC
900	870	890	OROSP90SC	OROSP90BC
1000	970	990	OROSPI00SC	–
1200	1170	1190	OROSPI20SC	–

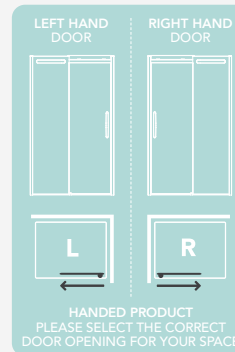

## ACCESSORIES

PRODUCT DESCRIPTION	CODE	CODE
	SILVER	MATTE BLACK
20mm Compensating Wall Profile	OROCB20SC	OROCB20BC



# SLIDING DOOR WITH TWO INLINE PANELS

SILVER

MATTE BLACK

The Sliding Door with two inline panels provides a sleek, contemporary look while maximizing space.

The patented magnetic guide system is designed to guarantee the smoothest motion as the door glides around the bottom rail.

The sliding door with two inline panels can be installed in an alcove or with a frameless side panel option and is the perfect choice for a large, luxurious showering zone.

## DOOR SIZE OPTIONS

PRODUCT SIZE (mm)	ADJUSTMENT SIZE		ACCESS (mm)	CODE	CODE
	MIN (mm)	MAX (mm)		SILVER	MATTE BLACK
1200 - Left Hand	1160	1200	412	OROSA2IL120LSC	OROSA2IL120LBC
1200 - Right Hand	1160	1200	412	OROSA2IL120RSC	OROSA2IL120RBC
1400 - Left Hand	1360	1400	493	OROSA2IL140LSC	OROSA2IL140LBC
1400 - Right Hand	1360	1400	493	OROSA2IL140RSC	OROSA2IL140RBC
1500 - Left Hand	1460	1500	542	OROSA2IL150LSC	OROSA2IL150LBC
1500 - Right Hand	1460	1500	542	OROSA2IL150RSC	OROSA2IL150RBC
1600 - Left Hand	1560	1600	542	OROSA2IL160LSC	OROSA2IL160LBC
1600 - Right Hand	1560	1600	542	OROSA2IL160RSC	OROSA2IL160RBC
1700 - Left Hand	1660	1700	614	OROSA2IL170LSC	OROSA2IL170LBC
1700 - Right Hand	1660	1700	614	OROSA2IL170RSC	OROSA2IL170RBC
1800 - Left Hand	1760	1800	614	OROSA2IL180LSC	OROSA2IL180LBC
1800 - Right Hand	1760	1800	614	OROSA2IL180RSC	OROSA2IL180RBC
1900 - Left Hand	1860	1900	614	OROSA2IL190LSC	—
1900 - Right Hand	1860	1900	614	OROSA2IL190RSC	—
2000 - Left Hand	1960	2000	614	OROSA2IL200LSC	OROSA2IL200LBC
2000 - Right Hand	1960	2000	614	OROSA2IL200RSC	OROSA2IL200RBC

## FRAMELESS SIDE PANEL OPTIONS \*To suit sliding door with two inline panels only

PRODUCT SIZE (mm)	ADJUSTMENT SIZE		CODE	CODE
	MIN (mm)	MAX (mm)	SILVER	MATTE BLACK
700 (SA2IL specific)	660	680	OROSA2ILSP70SC	OROSA2ILSP70BC
800 (SA2IL specific)	760	780	OROSA2ILSP80SC	OROSA2ILSP80BC
900 (SA2IL specific)	860	880	OROSA2ILSP90SC	OROSA2ILSP90BC
1000 (SA2IL specific)	960	980	OROSA2ILSP100SC	OROSA2ILSP100BC
1200 (SA2IL specific)	1160	1180	OROSA2ILSP120SC	OROSA2ILSP120BC

Note - Two side panels can be made used to make a three sided enclosure.



8mm  
TOUGHENED SAFETY GLASS



2000mm  
HEIGHT

OVERALL



40mm  
PROFILE ADJUSTMENT



10mm  
ULTRA LOW BOTTOM RAIL



CLEARVUE  
GLASS COATING



SEAMLESS  
INTERIOR  
COVER STRIPS



ULTRA CLEAR  
SEALS



CUSHION CLOSE  
DAMPENER  
MECHANISM



PATENTED  
MAGNETIC  
GUIDE SYSTEM



AVAILABLE IN  
SILVER &  
MATTE BLACK



LIFETIME  
GUARANTEE

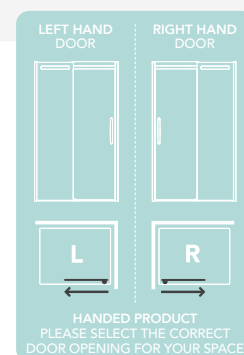



RIGHT HAND SLIDING DOOR WITH TWO INLINE PANELS AND FRAMELESS SIDE PANEL\* - SILVER



LEFT HAND SLIDING DOOR WITH TWO INLINE PANELS IN ALCOVE - SILVER



RIGHT HAND SLIDING DOOR WITH TWO INLINE PANELS AND TWO TWO FRAMELESS SIDE PANELS\* - SILVER

# SLIDING QUADRANT DOOR

SILVER

MATTE BLACK

Creative engineering has shaped the unique ORO Sliding Quadrant. The top floating rail design ingeniously encloses the roller system to give the door a sleek polished look. Practically speaking, the concealed rollers ensure reduced cleaning time.

Functional distinction continues with the **patented magnetic guide system** – this design innovation guarantees the smoothest motion as the door glides around the bottom rail. The final detail is the **crafted handle design**, befitting for the overall elegance of this door.

## DOOR SIZE OPTIONS

PRODUCT ADJUSTMENT SIZE SIZE (mm)*MIN (mm)	ACCESS CODE MAX (mm) (mm)			SILVER	MATTE BLACK
900 - Left Hand	870 890	480		OROSQ90LSC	OROSQ90LBC
900 - Right Hand	870 890	480		OROSQ90RSC	OROSQ90RBC
1000 - Left Hand <b>NEW</b>	970 990	480		OROSQ100LSC	OROSQ100LBC
1000 - Right Hand <b>NEW</b>	970 990	480		OROSQ100RSC	OROSQ100RBC

## ACCESSORIES

PRODUCT DESCRIPTION	CODE SILVER	CODE MATTE BLACK
	20mm Compensating Wall Profile	OROCB20SC

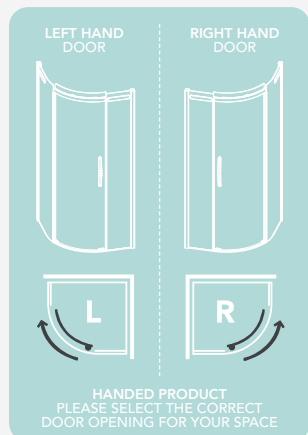

- 8mm** TOUGHENED SAFETY GLASS
- 2000mm** HEIGHT
- 20mm** PROFILE ADJUSTMENT
- 10mm** ULTRA LOW BOTTOM RAIL
- CRAFTED HANDLE DESIGN
- ULTRA CLEAR SEALS
- AVAILABLE IN SILVER & MATTE BLACK
- PATENTED MAGNETIC GUIDE SYSTEM
- CUSHION CLOSE DAMPENER MECHANISM
- CLEARVUE GLASS COATING
- LIFETIME GUARANTEE





SLIDING QUADRANT (RIGHT HAND) - MATTE BLACK



SLIDING QUADRANT  
(RIGHT HAND) - SILVER



SLIDING OFFSET QUADRANT (RIGHT HAND) - SILVER  
(to suit right hand offset quadrant shower tray)



SLIDING OFFSET QUADRANT (RIGHT HAND) - MATTE BLACK  
(to suit right hand offset quadrant shower tray)

# SLIDING OFFSET QUADRANT DOOR

SILVER

MATTE BLACK

Generously proportioned, the ORO Sliding Offset Quadrant is designed to impress in your bathroom. The signature floating rail design cleverly encloses the rollers to give the door a sleek appearance.

Design excellence continues with the **patented magnetic guide system** ensuring the smoothest of motion as the door glides around the bottom rail. The **crafted chrome handles** have perfect symmetry, in line with the overall elegance of the door.

## DOOR SIZE OPTIONS

PRODUCT SIZE (mm)	ADJUSTMENT SIZE		ACCESS (mm)	CODE	CODE
	MIN (mm)	MAX (mm)		SILVER	MATTE BLACK
1000 x 800 - Left Hand	770-970	790-990	480	OROSQ80X100LSC	—
1000 x 800 - Right Hand	770-970	790-990	480	OROSQ80X100RSC	—
1000 x 900 - Left Hand	870-970	890-990	480	OROSQ90X100LSC	—
1000 x 900 - Right Hand	870-970	890-990	480	OROSQ90X100RSC	—
1200 x 800 - Left Hand	770-1170	790-1190	480	OROSQ80X120LSC	OROSQ80X120LBC
1200 x 800 - Right Hand	770-1170	790-1190	480	OROSQ80X120RSC	OROSQ80X120RBC
1200 x 900 - Left Hand	870-1170	890-1190	480	OROSQ90X120LSC	OROSQ90X120LBC
1200 x 900 - Right Hand	870-1170	890-1190	480	OROSQ90X120RSC	OROSQ90X120RBC

## ACCESSORIES

PRODUCT DESCRIPTION	CODE SILVER	CODE MATTE BLACK
20mm Compensating Wall Profile	OROCB20SC	OROCB20BC

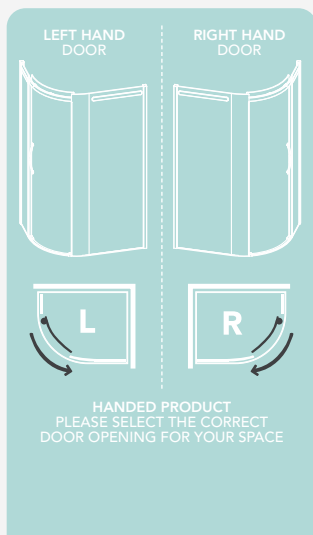

8mm TOUGHENED SAFETY GLASS	2000mm HEIGHT	20mm PROFILE ADJUSTMENT	10mm ULTRA LOW BOTTOM RAIL
CRAFTED HANDLE DESIGN	ULTRA CLEAR SEALS	PATENTED MAGNETIC GUIDE SYSTEM	SEAMLESS INTERIOR COVER STRIPS
CUSHION CLOSE DAMPENER MECHANISM	CLEARVUE GLASS COATING	AVAILABLE IN SILVER & MATTE BLACK	LIFETIME GUARANTEE

# HINGED QUADRANT DOOR

SILVER

MATTE BLACK

A hallmark of elegance, the ORO Hinged Quadrant will add a touch of class to your bathroom.

The frameless curved glass is supported by 2 stainless steel stabilising bars that blend seamlessly into the door silhouette. Flush to glass interior **counter sunk hinges** allows you to easily wipe the shower glass clean. Precise in its action, this curved hinge door is secured by **ultra clear magnetic seals** that deliver the perfect positive close action every time.

## DOOR SIZE OPTIONS

PRODUCT SIZE (mm)	ADJUSTMENT SIZE		ACCESS (mm)	CODE SILVER	CODE MATTE BLACK
	MIN (mm)	MAX (mm)			
900 - Left Hand	870	890	570	OROHQ90LSC	OROHQ90LBC
900 - Right Hand	870	890	570	OROHQ90RSC	OROHQ90RBC
1000 - Left Hand	970	990	570	OROHQ100LSC	OROHQ100LBC
1000 - Right Hand	970	990	570	OROHQ100RSC	OROHQ100RBC

## ACCESSORIES

PRODUCT DESCRIPTION	CODE SILVER	CODE MATTE BLACK
20mm Compensating Wall Profile	OROCB20SC	OROCB20BC

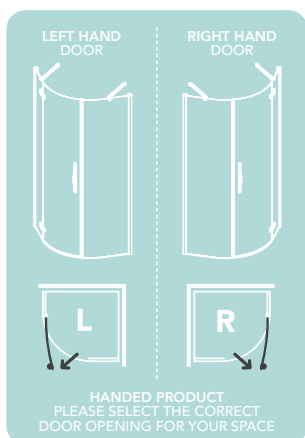

- 8mm TOUGHENED SAFETY GLASS
- 2000mm HEIGHT
- 20mm PROFILE ADJUSTMENT
- COUNTERSUNK INTERIOR HINGES
- 10mm ULTRA LOW BOTTOM RAIL
- CRAFTED HANDLE DESIGN
- ULTRA CLEAR SEALS
- SEAMLESS INTERIOR COVER STRIPS
- STAINLESS STEEL ANGLED STABILISING BARS
- CLEARVUE GLASS COATING
- AVAILABLE IN SILVER & MATTE BLACK
- LIFETIME GUARANTEE







HINGED QUADRANT (LEFT HAND) - MATTE BLACK



HINGED QUADRANT (RIGHT HAND) - SILVER



HINGED OFFSET QUADRANT (RIGHT HAND) - SILVER  
(to suit right hand offset quadrant shower tray)



HINGED OFFSET QUADRANT  
(RIGHT HAND) - MATTE BLACK  
(to suit right hand offset quadrant shower tray)

# HINGED OFFSET QUADRANT DOOR

SILVER

MATTE BLACK

Setting the standard in frameless design, the ORO Offset Hinged Quadrant is a shower door of sheer beauty and elegance for your bathroom. The curved frameless glass is supported by 2 minimalist stainless steel stabilising bars. Flush to glass interior counter sunk hinges allow you to easily wipe the shower glass clean.

Precise in its action, the curved hinge door is secured by ultra clear magnetic seals that give the perfect close on the shower enclosure.



CRAFTED HANDLE DESIGN



STAINLESS STEEL STABILISING BAR WITH CONCEALED FIXINGS

## DOOR SIZE OPTIONS

PRODUCT SIZE (mm)	ADJUSTMENT SIZE		ACCESS (mm)	CODE	CODE
	MIN (mm)	MAX (mm)		SILVER	MATTE BLACK
1000 x 800 - Left Hand	770-970	790-990	570	OROHQ80X100LSC	—
1000 x 800 - Right Hand	770-970	790-990	570	OROHQ80X100RSC	—
1000 x 900 - Left Hand	870-970	890-990	570	OROHQ90X100LSC	—
1000 x 900 - Right Hand	870-970	890-990	570	OROHQ90X100RSC	—
1200 x 800 - Left Hand	770-1170	790-1190	570	OROHQ80X120LSC	OROHQ80X120LBC
1200 x 800 - Right Hand	770-1170	790-1190	570	OROHQ80X120RSC	OROHQ80X120RBC
1200 x 900 - Left Hand	870-1170	890-1190	570	OROHQ90X120LSC	OROHQ90X120LBC
1200 x 900 - Right Hand	870-1170	890-1190	570	OROHQ90X120RSC	OROHQ90X120RBC

## ACCESSORIES

PRODUCT DESCRIPTION	CODE SILVER	CODE MATTE BLACK
20mm Compensating Wall Profile	OROCB20SC	OROCB20BC

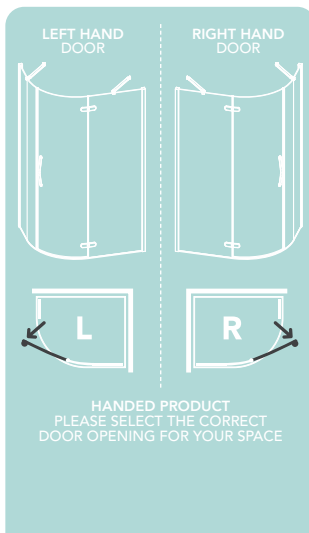

- 8mm TOUGHENED SAFETY GLASS
- 2000mm HEIGHT
- 20mm PROFILE ADJUSTMENT
- COUNTERSUNK INTERIOR HINGES
- CRAFTED HANDLE DESIGN
- ULTRA CLEAR SEALS
- SEAMLESS INTERIOR COVER STRIPS
- 10mm ULTRA LOW BOTTOM RAIL
- STAINLESS STEEL ANGLED STABILISING BARS
- CLEARVUE GLASS COATING
- AVAILABLE IN SILVER & MATTE BLACK
- LIFETIME GUARANTEE

# BIFOLD DOOR

SILVER MATTE BLACK

The ingenious design of the ORO Bifold Door makes it a firm favourite amongst this 8mm shower door range.

The innovative 180 degree hinge mechanism enables the door to open inwards and outwards, offering you total flexibility. A self stop hinge action prevents the door glass extending into contact with the shower wall or door hinges. The bifold hinge is meticulously engineered giving this frameless door exceptional stability. The signature ORO handle design adds the finishing touch to this bijoux beauty.

## DOOR SIZE OPTIONS

PRODUCT SIZE (mm)	ADJUSTMENT SIZE (mm)		ACCESS (mm)	CODE SILVER	CODE MATTE BLACK
	MIN	MAX			
700	660	700	483	OROBF70SC	-
760	720	760	538	OROBF76SC	-
800	760	800	575	OROBF80SC	OROBF80BC
900	860	900	668	OROBF90SC	OROBF90BC
1000	960	1000	759	OROBF100SC	OROBF100BC

## SEMI FRAMED SIDE PANEL OPTIONS (INCLUDES CORNER PROFILE)

PRODUCT SIZE (mm)	ADJUSTMENT SIZE (mm)		CODE SILVER	CODE MATTE BLACK
	MIN	MAX		
700	670	690	OROSP70SC	OROSP70BC
760	730	750	OROSP76SC	OROSP76BC
800	770	790	OROSP80SC	OROSP80BC
900	870	890	OROSP90SC	OROSP90BC
1000	970	990	OROSP100SC	-
1200	1170	1190	OROSP120SC	-

## ACCESSORIES

PRODUCT CODE SIZE (mm)	CODE SILVER	CODE MATTE BLACK
20mm Compensating Wall Profile	OROCB20SC	OROCB20BC
Raised Stabilising Bar 1050mmS-ORO105HSSB	S-ORO105HSSB	S-ORO105HSSBMB

Note - Stabilising bar must be purchased with the bifold door and semi framed side panel with polished silver corner profile.

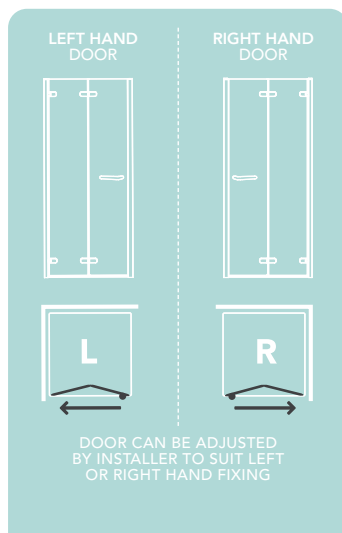

UNIVERSAL - SUITS LEFT OR RIGHT HAND OPENING





BIFOLD DOOR (LEFT HAND) IN ALCOVE - MATTE BLACK

8mm  
TOUGHENED  
SAFETY  
GLASS

2000mm  
HEIGHT

OVERALL  
40mm  
PROFILE  
ADJUSTMENT

10mm  
ULTRA LOW  
BOTTOM RAIL

ULTRA CLEAR  
SEALS

SEAMLESS  
INTERIOR  
COVER STRIPS

UNIVERSAL  
LEFT OR RIGHT  
HAND OPENING

CLEARVUE  
GLASS COATING

AVAILABLE IN  
SILVER &  
MATTE BLACK

LIFETIME  
GUARANTEE

# HINGE DOOR

SILVER

MATTE BLACK

Experience perfection with the 8mm ORO hinge door. Ideal for smaller spaces, this frameless door features curved radius detailing throughout. Interior fixation points are discreetly concealed by an innovative cover cap design. The countersunk interior hinges allow you to wipe the shower glass clean with ease.

Ultra clear magnetic seals give the hinge door a reassuring close action. The finishing touch is the crafted chrome handles – shaped to give a tactile feeling of smooth perfection.

## DOOR SIZE OPTIONS

PRODUCT SIZE (mm)	ADJUSTMENT SIZE		ACCESS (mm)	CODE SILVER	CODE MATTE BLACK
	MIN (mm)	MAX (mm)			
800	760	800	660	OROHD80SC	OROHD80BC
900	860	900	760	OROHD90SC	OROHD90BC
1000	960	1000	860	OROHD100SC	–

## SEMI FRAMED SIDE PANEL OPTIONS (INCLUDES CORNER PROFILE)

PRODUCT SIZE (mm)	ADJUSTMENT SIZE		CODE SILVER	CODE MATTE BLACK
	MIN (mm)	MAX (mm)		
700	670	690	OROSP70SC	OROSP70BC
760	730	750	OROSP76SC	OROSP76BC
800	770	790	OROSP80SC	OROSP80BC
900	870	890	OROSP90SC	OROSP90BC
1000	970	990	OROSP100SC	–
1200	1170	1190	OROSP120SC	–

## ACCESSORIES

PRODUCT CODE	CODE SILVER	CODE MATTE BLACK
20mm Compensating Wall Profile	OROCB20SC	OROCB20BC
Raised Stabilising Bar 1050mmS-ORO105SSBS-ORO105SSBMB		

Note - Stabilising bar must be purchased with the with the hinge door and semi framed side panel with polished silver corner profile.

HINGE DOOR (LEFT HAND) IN ALCOVE - MATTE BLACK



## UNIVERSAL - SUITS LEFT OR RIGHT HAND OPENING

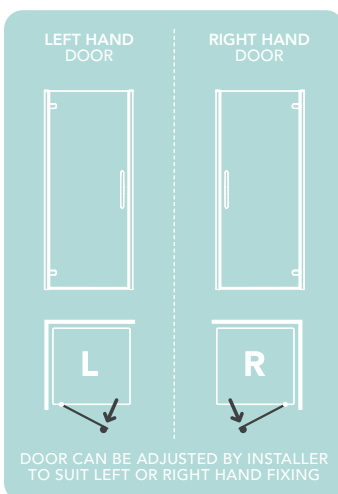

STAINLESS STEEL STRAIGHT STABILISING BAR

8mm TOUGHENED SAFETY GLASS

2000mm HEIGHT

OVERALL 40mm PROFILE ADJUSTMENT

10mm ULTRA LOW BOTTOM RAIL

CLEARVUE GLASS COATING

AVAILABLE IN SILVER & MATTE BLACK

CRAFTED HANDLE DESIGN

ULTRA CLEAR SEALS

SEAMLESS INTERIOR COVER STRIPS

UNIVERSAL LEFT OR RIGHT HAND OPENING

LIFETIME GUARANTEE



HINGE DOOR (LEFT HAND) WITH SEMI FRAMED SIDE PANEL - SILVER

# INLINE PANEL TO SUIT HINGE DOOR

SILVER

MATTE BLACK

The ORO hinge door installed with an inline panel is a practical yet elegant option for the bathroom.

The inline panels offer a great degree of flexibility, with a wide variety of sizes available. This sleek frameless shower door design is suitable for alcove/ recess installation only.

## INLINE PANEL OPTIONS

PRODUCT CODE SIZE (mm)	CODE SILVER	CODE MATTE BLACK
100 (No Stabilising Bar Required)	OROIL10SC	–
200 (No Stabilising Bar Required)	OROIL20SC	–
300 (450mm Stabilising Bar Included)	OROIL30SC	OROIL30BC
400 (450mm Stabilising Bar Included)	OROIL40SC	OROIL40BC
500 (450mm Stabilising Bar Included)	OROIL50SC	–
600 (450mm Stabilising Bar Included)	OROIL60SC	–











## HINGE DOOR OPTIONS

PRODUCT SIZE (mm)	ADJUSTMENT MIN (mm)	ADJUSTMENT MAX (mm)	ACCESS (mm)	CODE SILVER	CODE MATTE BLACK
800	760	800	660	OROHD80SC	OROHD80BC
900	860	900	760	OROHD90SC	OROHD90BC
1000	960	1000	860	OROHD100SC	–

## BOTTOM BARRIER BAR – TO SUIT HINGE DOOR WITH INLINE PANEL APPLICATION

PRODUCT CODE SIZE (mm)	CODE SILVER	CODE MATTE BLACK
Bottom Barrier Bar   600mm	OROILBB-BFHDS	OROILBB-BFHDB

Note - Inline panels only suitable for alcove or recess application (not compatible with side panels)

 8mm TOUGHENED SAFETY GLASS	 2000mm HEIGHT	 40mm OVERALL PROFILE ADJUSTMENT	 10mm ULTRA LOW BOTTOM RAIL	 CLEARVUE GLASS COATING	 AVAILABLE IN SILVER & MATTE BLACK
 CRAFTED HANDLE DESIGN	 ULTRA CLEAR SEALS	 SEAMLESS INTERIOR COVER STRIPS	 UNIVERSAL LEFT OR RIGHT HAND OPENING	 LIFETIME GUARANTEE	







HINGE DOOR WITH INLINE PANEL IN ALCOVE - SILVER



HINGE & INLINE DOOR (RIGHT HAND) WITH SEMI FRAMED SIDE PANEL - MATTE BLACK



HINGE & INLINE DOOR (LEFT HAND) IN ALCOVE - SILVER

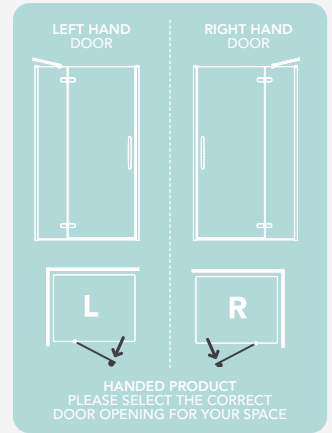

### HINGE & INLINE OPEN POSITION MEASUREMENTS

DOOR SIZE	FIXED INLINE PANEL SIZE	DOOR OPEN EXTERNAL PROTRUSION*
1100mm	350mm	770mm
1200mm	400mm	770mm
1400mm	600mm	770mm
1600mm	750mm	770mm

\*Door opens to 90° angle.

**8mm**  
TOUGHENED SAFETY GLASS

**2000mm**  
HEIGHT

OVERALL  
**40mm**  
PROFILE ADJUSTMENT

**10mm**  
ULTRA LOW BOTTOM RAIL

CLEARVUE  
GLASS COATING

AVAILABLE IN  
SILVER &  
MATTE BLACK

CRAFTED  
HANDLE DESIGN

ULTRA CLEAR  
SEALS

SEAMLESS  
INTERIOR  
COVER STRIPS

UNIVERSAL  
LEFT OR RIGHT  
HAND OPENING

LIFETIME  
GUARANTEE

# HINGE & INLINE DOOR

SILVER

MATTE BLACK

Striking in its appearance, the ORO Hinge and Inline door is a statement piece for your bathroom.

The **gently curved hinges** have a countersunk interior design and can be wiped clean with ease. The **T-bar stabiliser** has concealed fixings and its sleek construction blends subtly into the products profile. Ultra clear magnetic seals giving a superior close action. The finishing touch is the **crafted chrome handles**, their perfect symmetry complementing the overall elegance of the door.

## DOOR SIZE OPTIONS

PRODUCT SIZE (mm)	ADJUSTMENT SIZE		ACCESS (mm)	CODE SILVER	CODE MATTE BLACK
	MIN (mm)	MAX (mm)			
1100 - Left Hand	1060	1100	740	OROHD110LSC	–
1100 - Right Hand	1060	1100	740	OROHD110RSC	–
1200 - Left Hand	1160	1200	740	OROHD120LSC	OROHD120LBC
1200 - Right Hand	1160	1200	740	OROHD120RSC	OROHD120RBC
1400 - Left Hand	1360	1400	740	OROHD140LSC	–
1400 - Right Hand	1360	1400	740	OROHD140RSC	–
1600 - Left Hand	1560	1600	740	OROHD160LSC	–
1600 - Right Hand	1560	1600	740	OROHD160RSC	–

Angled stabilising bar included with each door.

## SEMI FRAMED SIDE PANEL OPTIONS (INCLUDES CORNER PROFILE)

PRODUCT SIZE (mm)	ADJUSTMENT SIZE		CODE SILVER	CODE MATTE BLACK
	MIN (mm)	MAX (mm)		
700	670	690	OROSP70SC	OROSP70BC
760	730	750	OROSP76SC	OROSP76BC
800	770	790	OROSP80SC	OROSP80BC
900	870	890	OROSP90SC	OROSP90BC
1000	970	990	OROSPI00SC	–
1200	1170	1190	OROSPI20SC	–

## ACCESSORIES

PRODUCT CODE SIZE (mm) SILVER	CODE MATTE BLACK		
20mm Compensating Wall Profile		OROCB20SC	OROCB20BC
Straight Stabilising Bar 1600mm with T Piece		S-ORO160SSB+TB	S-ORO160SSBMB+TB

Note - Stabilising bar must be purchased with the hinge and inline door and semi framed side panel. Stabilising bar is standard 1600mm and can be resized to suit all door sizes.

# INLINE PANEL TO SUIT HINGE & INLINE DOOR

SILVER

MATTE BLACK

The ORO hinge & Inline door installed with an inline panel achieves a luxurious, spacious feel whilst not compromising on functionality.

With an emphasis on frameless aesthetics, the curved hinges are countersunk on the interior allowing for effortless cleaning of the shower glass. The 8mm toughened safety glass stands at 2 metres tall and boasts Clearvue hydrophobic coating, making this shower door the perfect blend of form and function.

## INLINE PANEL OPTIONS

PRODUCT CODE SIZE (mm) SILVER	CODE MATTE BLACK		
100 (No Stabilising Bar Required) OROIL10SC		–	
200 (No Stabilising Bar Required) OROIL20SC		–	
300 (450mm Stabilising Bar Included) OROIL30SC		OROIL30BC	
400 (450mm Stabilising Bar Included)		OROIL40SC	OROIL40BC
500 (450mm Stabilising Bar Included) OROIL50SC		–	
600 (450mm Stabilising Bar Included)		OROIL60SC	–











## HINGE AND INLINE DOOR OPTIONS

PRODUCT SIZE (mm)	ADJUSTMENT SIZE			ACCESS (mm)	CODE SILVER	CODE MATTE BLACK
	MIN (mm)	MAX (mm)				
1100 - Left Hand	1060	1100	740		OROHD110LSC	–
1100 - Right Hand	1060	1100	740		OROHD110RSC	–
1200 - Left Hand	1160	1200	740		OROHD120LSC	OROHD120LBC
1200 - Right Hand	1160	1200	740		OROHD120RSC	OROHD120RBC

## BOTTOM BARRIER BAR – TO SUIT HINGE AND INLINE DOOR WITH INLINE PANEL APPLICATION

PRODUCT CODE SIZE (mm) SILVER	CODE MATTE BLACK		
Bottom Barrier Bar 2200mm OROILBB-HDILS			OROILBB-HDILB

Note - Inline panels only suitable for alcove or recess application (not compatible with side panels)

 8mm TOUGHENED SAFETY GLASS	 2000mm HEIGHT	 OVERALL 40mm PROFILE ADJUSTMENT	 10mm ULTRA LOW BOTTOM RAIL	 CLEARVUE GLASS COATING	 AVAILABLE IN SILVER & MATTE BLACK
 CRAFTED HANDLE DESIGN	 ULTRA CLEAR SEALS	 SEAMLESS INTERIOR COVER STRIPS	 UNIVERSAL LEFT OR RIGHT HAND OPENING	 LIFETIME GUARANTEE	





HINGE & INLINE DOOR WITH INLINE PANEL IN ALCOVE - SILVER

# BIFOLD DOOR WITH ULTRA FRAMELESS CORNER SIDE PANEL

SILVER

MATTE BLACK

The ORO Bifold and ultra frameless corner side panel is a truly versatile shower door choice. Designed to open both inwards and outwards, the self stop hinge mechanism prevents the bifold door from folding into contact with the glass panels. The **raised stabilising bar** is engineered to accompany the **frameless corner side panel** and with its extra height, allows the door to fold inwards without restriction.

## STEP 1 - SELECT SIZE OF ULTRA FRAMELESS CORNER SIDE PANEL

PRODUCT SIZE (mm)	ADJUSTMENT SIZE CODE		CODE SILVER	CODE MATTE BLACK
	MIN (mm)	MAX (mm)		
700	660	680	OROCSP70SC	—
760	720	740	OROCSP76SC	—
800	760	780	OROCSP80SC	OROCSP80BC
900	860	880	OROCSP90SC	OROCSP90BC
1000	960	980	OROCSP100SC	—

## STEP 2 - SELECT SIZE OF DOOR

PRODUCT SIZE (mm)	ADJUSTMENT SIZE		ACCESS (mm)	CODE SILVER	CODE MATTE BLACK
	MIN (mm)	MAX (mm)			
700	660	700	483	OROBF70SC	—
760	720	760	538	OROBF76SC	—
800	760	800	575	OROBF80SC	OROBF80BC
900	860	900	668	OROBF90SC	OROBF90BC
1000	960	1000	759	OROBF100SC	OROBF100BC

## STEP 3 - CHOOSE CORNER INLINE PANEL KIT SIZE

PRODUCT CODE	SIZE (mm)	CODE SILVER	CODE MATTE BLACK
200	OROKIT2	—	—
300	OROKIT3	OROKIT3B	—
400	OROKIT4	OROKIT4B	—

### NOTE - BIFOLD DOOR SIZE PLUS CORNER INLINE PANEL SIZE WILL TOTAL TO THE WIDTH OF YOUR SHOWER TRAY.

Each corner inline panel kit includes the following components:  
 Inline panel, bottom barrier bar and stabilising bar with fixing brackets.  
 Ultra clear seal or 3M tape option supplied for corner inline panel fixation.

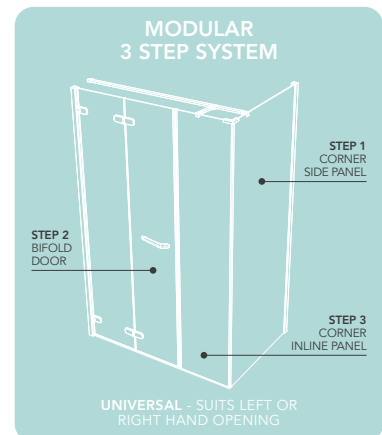



BIFOLD DOOR (LEFT HAND) WITH  
ULTRA FRAMELESS CORNER SIDE PANEL - MATTE BLACK



BIFOLD DOOR  
(LEFT HAND) WITH  
ULTRA FRAMELESS  
CORNER SIDE  
PANEL - SILVER

# HINGE DOOR WITH ULTRA FRAMELESS CORNER SIDE PANEL

SILVER MATTE BLACK

The ORO Hinge Door and ultra frameless corner side panel radiates style and contemporary elegance.

This **corner side panel system** is modular, giving you flexibility with your door and inline panel sizing to suit your shower tray. Minimally designed but with durability in mind, the corner side panel is supported by a **sleek chrome stabilising bar**.

## STEP 1 - SELECT SIZE OF ULTRA FRAMELESS CORNER SIDE PANEL

PRODUCT SIZE (mm)	ADJUSTMENT SIZE CODE		CODE SILVER	CODE MATTE BLACK
	MIN (mm)	MAX (mm)		
700	660	680	OROCSP70SC	—
760	720	740	OROCSP76SC	—
800	760	780	OROCSP80SC	OROCSP80BC
900	860	880	OROCSP90SC	OROCSP90BC
1000	960	980	OROCSP100SC	—

## STEP 2 - SELECT SIZE OF DOOR

PRODUCT SIZE (mm)	ADJUSTMENT SIZE		ACCESS (mm)	CODE SILVER	CODE MATTE BLACK
	MIN (mm)	MAX (mm)			
800	760	800	660	OROHD80SC	OROHD80BC
900	860	900	760	OROHD90SC	OROHD90BC
1000	960	1000	860	OROHD100SC	—

## STEP 3 - CHOOSE CORNER INLINE PANEL KIT SIZE

PRODUCT CODE SIZE (mm)	CODE SILVER	CODE MATTE BLACK	CODE SILVER	CODE MATTE BLACK
200	OROKIT2	—	—	—
300	OROKIT3	OROKIT3B	—	—
400	OROKIT4	OROKIT4B	—	—

**NOTE - HINGE DOOR SIZE PLUS CORNER INLINE PANEL SIZE WILL TOTAL TO THE WIDTH OF YOUR SHOWER TRAY.**

Each corner inline panel kit includes the following components:  
 inline panel, bottom barrier bar and stabilising bar with fixing brackets.  
 Ultra clear seal or 3M tape option supplied for corner inline panel fixation.

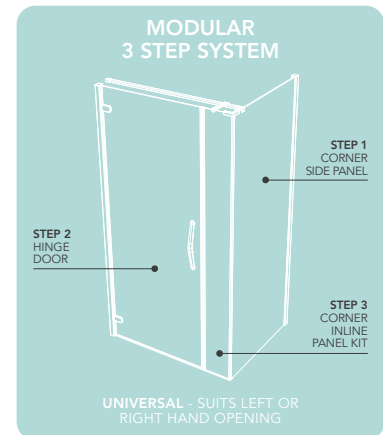





HINGE DOOR (LEFT HAND) WITH  
ULTRA FRAMELESS CORNER SIDE PANEL - SILVER



HINGE DOOR (RIGHT HAND)  
WITH ULTRA FRAMELESS CORNER  
SIDE PANEL - MATTE BLACK

# HINGE AND INLINE DOOR WITH ULTRA FRAMELESS CORNER SIDE PANEL

SILVER

MATTE BLACK

Setting the standard in frameless design, the ORO Hinge and Inline door with ultra frameless corner side panel will make a real style statement in your bathroom.

A generously proportioned shower enclosure, this modular design is ideal for larger showering spaces. With durability in mind, the corner side panel is supported by a minimalist chrome stabilising bar.

## STEP 1 - SELECT SIZE OF ULTRA FRAMELESS CORNER SIDE PANEL

PRODUCT SIZE (mm)	ADJUSTMENT SIZE		CODE	
	MIN (mm)	MAX (mm)		
700	660	680	OROCSP70SC	—
760	720	740	OROCSP76SC	—
800	760	780	OROCSP80SC	OROCSP80BC
900	860	880	OROCSP90SC	OROCSP90BC
1000	960	980	OROCSP100SC	—

## STEP 2 - SELECT SIZE OF DOOR

PRODUCT SIZE (mm)	ADJUSTMENT SIZE			ACCESS (mm)	CODE SILVER	CODE MATTE BLACK
	MIN (mm)	MAX (mm)				
1100 - Left Hand	1060	1100	740		OROHD110LSC	—
1100 - Right Hand	1060	1100	740		OROHD110RSC	—
1200 - Left Hand	1160	1200	740		OROHD120LSC	OROHD120LBC
1200 - Right Hand	1160	1200	740		OROHD120RSC	OROHD120RBC

## STEP 3 - CHOOSE CORNER INLINE PANEL KIT SIZE

PRODUCT SIZE (mm)	CODE SILVER	CODE MATTE BLACK
	100	OROKIT5
200	OROKIT6	—
300	OROKIT7	OROKIT7B
400	OROKIT8	OROKIT8B

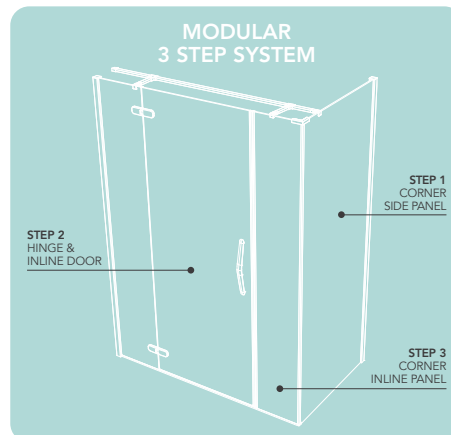
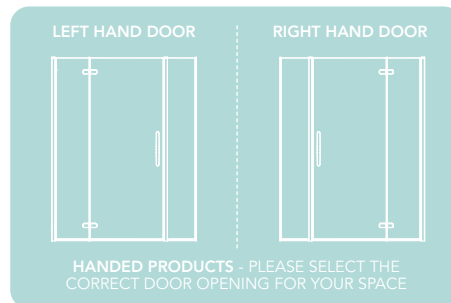

**NOTE - HINGE AND INLINE DOOR SIZE PLUS CORNER INLINE PANEL SIZE WILL TOTAL TO THE WIDTH OF YOUR SHOWER TRAY.**

\*Tolerance of 20mm in the inline panel measurement reflecting the 20mm profile adjustment.

Each corner inline panel kit includes the following components:  
 inline panel, bottom barrier bar and stabilising bar with fixing brackets.  
 Ultra clear seal or 3M tape option supplied for corner inline panel fixation.

HINGE AND INLINE DOOR (LEFT HAND) WITH  
ULTRA FRAMELESS CORNER SIDE PANEL - MATTE BLACK



HINGE AND INLINE DOOR  
(RIGHT HAND)  
WITH ULTRA FRAMELESS  
CORNER SIDE PANEL - MATTE BLACK

8mm  
TOUGHENED  
SAFETY  
GLASS

2000mm  
HEIGHT

20mm  
CORNER  
SIDE PANEL  
ADJUSTMENT

20mm  
DOOR  
ADJUSTMENT

10mm  
ULTRA LOW  
BOTTOM RAIL

AVAILABLE IN  
SILVER &  
MATTE BLACK

CRAFTED  
HANDLE DESIGN

ULTRA CLEAR  
SEALS

SEAMLESS  
INTERIOR  
COVER STRIPS

SUITABLE FOR  
SHOWER TRAY  
INSTALLATION  
ONLY

CLEARVUE  
GLASS COATING

LIFETIME  
GUARANTEE

# ORO<sup>®</sup> DOOR STYLES & HANDED DOOR GUIDE

## SLIDING DOOR

Please select carefully the ORO Sliding Door that is the correct hand opening for your space.

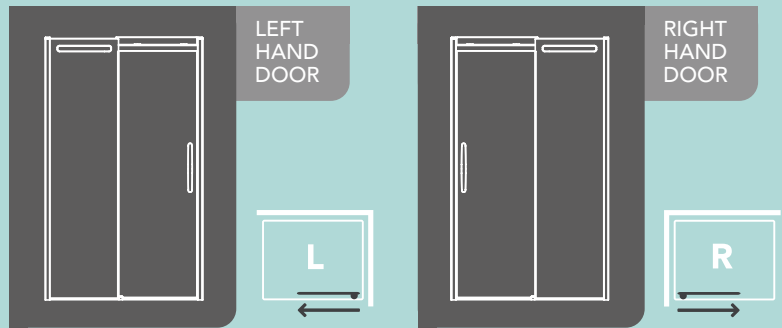

## SLIDING QUADRANT DOOR

Please select carefully the ORO Sliding Quadrant that is the correct hand opening for your space.

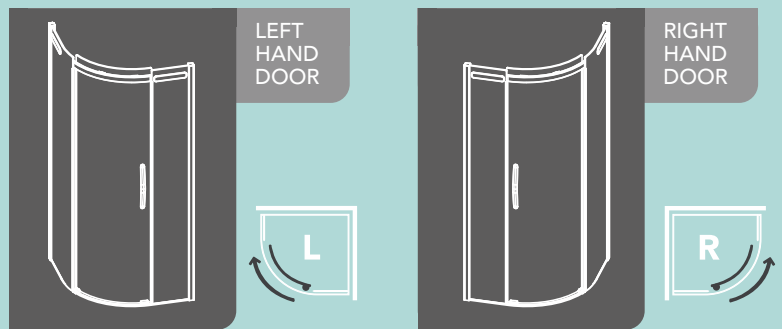

## SLIDING OFFSET QUADRANT DOOR

Please select carefully the ORO Sliding Offset Quadrant that is the correct shape for your offset shower tray.

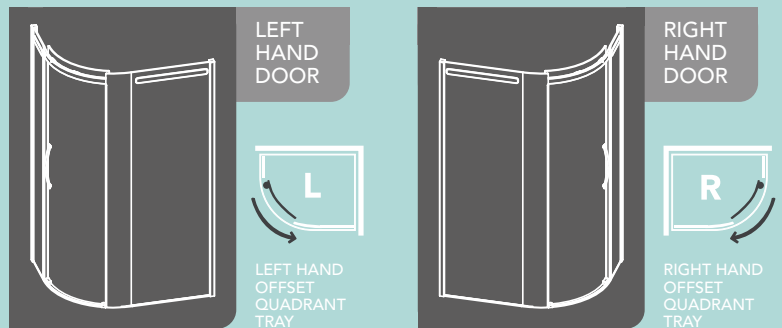

## HINGED QUADRANT DOOR

Please select carefully the ORO Hinged Quadrant that is the correct hand opening for your space.

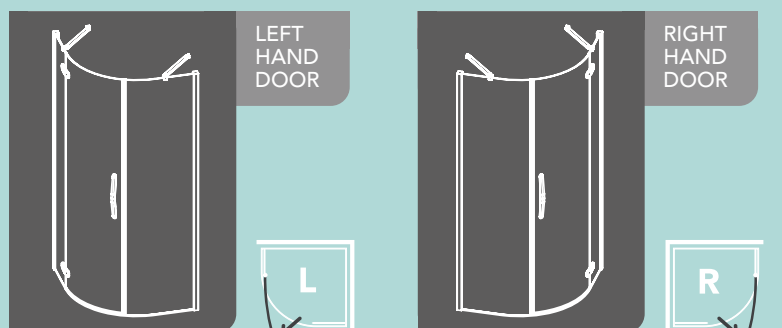

## HINGED OFFSET QUADRANT DOOR

Please select carefully the ORO Hinged Offset Quadrant that is the correct shape for your offset shower tray.

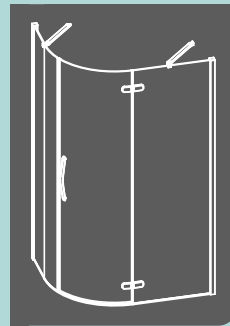

LEFT HAND DOOR



LEFT HAND OFFSET QUADRANT TRAY

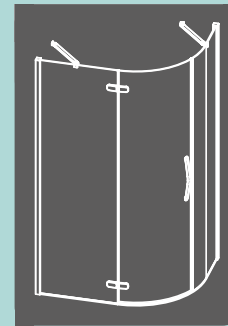

RIGHT HAND DOOR



RIGHT HAND OFFSET QUADRANT TRAY

## BIFOLD DOOR

The ORO Bifold Door is universal, so it can be adapted at installation to suit either left or right hand installation.

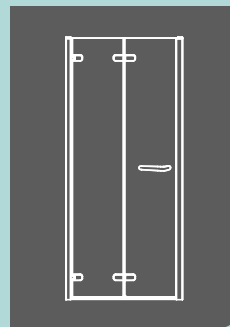

LEFT HAND INSTALLATION

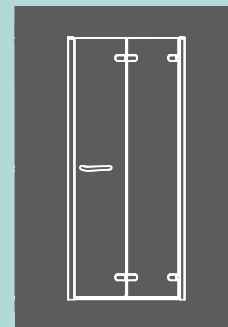

RIGHT HAND INSTALLATION



## HINGED DOOR

The ORO Hinged Door is universal, so it can be adapted at installation to suit either left or right hand installation.

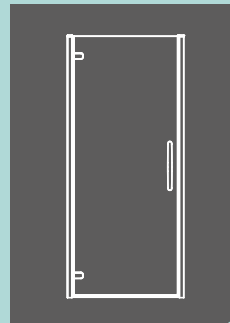

LEFT HAND INSTALLATION

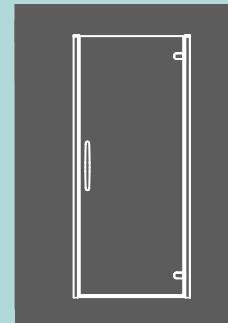

RIGHT HAND INSTALLATION



## HINGED AND INLINE DOOR

Please select carefully the ORO Hinge and Inline Door that is the correct hand opening for your space.

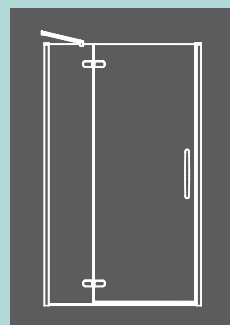

LEFT HAND DOOR

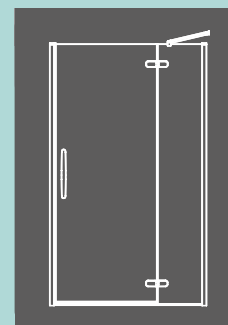

RIGHT HAND DOOR



# ORO<sup>®</sup> WATER RETENTION GUIDE

ORO Sliding Doors have an award winning design that reduces the need for invasive seals or large bottom rails allowing the customer a unique frameless showering experience.

As standard, ORO Sliding Doors come with a minimalist bottom barrier bar that does not include the use of an invasive seal or large bottom rail as part of the frameless design.

The ORO enclosure range is tested and certified for water retention in accordance with EN14428 where conventional showering practices are used and the product has been fitted in accordance with the Flair Fitting Instructions.

However, in unconventional showering practices, to further improve water retention and minimise any water escaping from the shower enclosure we have designed additional water retention solutions for optional use by customers.

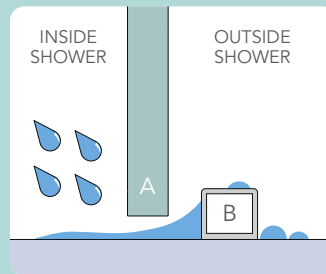

A - Sliding Door Glass  
B - Minimal Barrier Bar



## OPTION 1 THRESHOLD SEAL

The ORO Threshold seal is a minimal 15mm high silver profile with a discreet clear seal that can be easily fitted on top of the barrier bar during or after installation.

The Threshold seal will provide an increased level of water retention and protect against large surges of water escaping from the shower area. ORO Threshold seals are readily available from Flair Showers and can be ordered using the below product codes.

### Product Codes:

S-OROSA110TSS, S-OROSA120TSS,  
S-OROSA140-160TSS, S-OROSQTSS

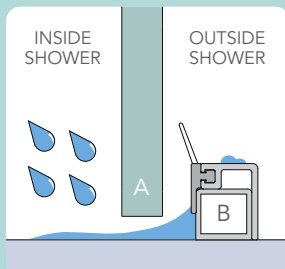

A - Sliding Door Glass  
B - Minimal Barrier Bar  
I - Threshold Seal



## OPTION 2 THRESHOLD BARRIER BAR

The ORO Threshold Barrier Bar is a larger 27mm high barrier bar which can be easily fitted on top of the barrier bar during or after installation.

The Threshold Barrier Bar offers the highest level of water retention available in the ORO Frameless Sliding Door's design. ORO Threshold Barrier Bars are readily available from Flair Showers and can be ordered using the below product codes.

### Product Codes:

S-OROSA110TBS, S-OROSA120TBS,  
S-OROSA140-160TBS, S-OROSQTBS

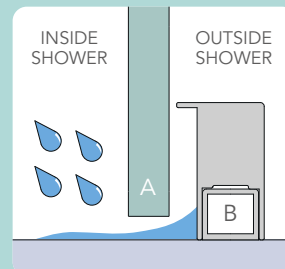

A - Sliding Door Glass  
B - Minimal Barrier Bar  
2 - Threshold Bar



# ORO<sup>®</sup> ALTERNATIVE HANDLES

An alternative choice of ORO handle design is now available. Created to deliver a sleek and contemporary aesthetic, these additional handle options are available in a Polished Chrome or Matte Black finish.

For ORO Range see pages 16-43.

## PRODUCT SIZE CODE

ORO Alternative Handle - Chrome (compatible with all ORO doors except bifold)	S-OROHLE2
ORO Alternative Handle - Matte Black (compatible with all ORO doors except bifold)	S-OROHLE2B
ORO Alternative Handle for Bifold - Chrome	S-ETO-OROHLE1
ORO Alternative Handle for Bifold - Matte Black	S-ETO-OROHLE1B



# ETO<sup>®</sup> ALTERNATIVE HANDLES

An alternative choice of ETO handle design is now available. Created to deliver a sleek and contemporary aesthetic, these additional handle options are available in a Polished Chrome, Matte Black or Brushed Brass finish.

For ETO Range see pages 60-93.

## PRODUCT SIZE CODE

ETO Alternative Handle - Chrome	S-ETO-OROHLE1
ETO Alternative Handle - Matte Black	S-ETO-OROHLE1B
ETO Alternative Handle - Brushed Brass	S-ETO-OROHLE1BRB





## DESIGN AWARD

Flair are proud to have received the **Good Design** Award accolade in recognition of the ETO shower door collection.

The **Good Design** Award is a seal of global design excellence and a testimony to our passion for product quality and innovation.



## PATENTED CLICK FIT ASSEMBLY SYSTEM



This screw free assembly mechanism revolutionises the way ETO shower doors are fitted, reducing assembly time dramatically for installers.



EXPLORE  
ETO





ETO

FRAMED 8mm  
SHOWER ENCLOSURE  
COLLECTION



# FINISHES

S - Silver  
B - Matte Black  
BRN - Brushed Nickel  
BRB - Brushed Brass  
BRZC - Brushed Bronze

\* Available Winter 2024.

# THE ETO<sup>®</sup> COLLECTION

## **Experience elegant practicality with ETO.**

Crafted to seamlessly integrate into your daily routine, the ETO shower door collection combines robust design with clever functional innovations.

The uniquely shaped handle is beautifully precise and features a cleverly integrated towel hook. Softly curved hinges with a countersunk finish and a slim profile design create a refined shower door aesthetic.

The stylish yet functional simplicity of the ETO collection embodies Design with Purpose, a concept which lies at the heart of this collection.



ETO INFOLD DOOR  
WITH SIDE PANEL

# THE ETO<sup>®</sup> COLLECTION

INFOLD  
DOOR

60

HINGE  
DOOR

64

HINGE &  
INLINE DOOR

68

SLIDING  
DOOR

72

ONE DOOR QUADRANT  
AND OFFSET QUADRANT

76

TWO DOOR  
QUADRANT

82

TWO DOOR  
OFFSET  
QUADRANT

84

CORNER  
ENTRY

86

---

# VISIONARY INNOVATIONS

MAGNETIC INFOLD  
LINKAGE SYSTEM



UNIQUELY CRAFTED  
ETO HANDLE  
WITH INTEGRATED  
ROBE HOOK

SOFTLY CURVED  
ETO HINGE DESIGN



COUNTER SUNK  
INTERIOR HINGES



ULTRA SLIM PROFILE  
AND COVER CAP DESIGN

# FUNCTIONAL DETAILS



2 METRES  
HIGH



VISUALLY ATTRACTIVE  
ULTRA CLEAR DOOR SEALS



8MM TOUGHENED  
SAFETY GLASS THICKNESS,  
CERTIFIED TO EN12150



SEAMLESS INTERIOR  
COVER STRIPS CONCEAL ALL  
FIXATION POINTS INTERNALLY



20MM ADJUSTMENT ON  
EACH WALL PROFILE



ULTRA SLIM COVER CAP  
DESIGN FOR A SLEEK AND  
MODERN DOOR AESTHETIC



PRECISELY CRAFTED SOLID CHROME  
PLATED ETO HANDLES THAT FEATURE  
AN INTEGRATED ROBE HOOK DESIGN



INNOVATIVE PRESS FIT SEAL DESIGN  
FOR EASE OF INSTALLATION



CLEARVUE IS A HYDROPHOBIC  
GLASS COATING THAT RESISTS  
THE BUILD UP OF LIMESCALE AND  
GRIME ON THE GLASS SURFACE



PRE ASSEMBLED DOOR FRAME  
ON INFOLD & HINGE DOOR -  
FOR EASE OF INSTALLATION



A MAGNETIZED PISTON DOOR  
CLOSE MECHANISM GIVES ETO  
SLIDING DOORS A CONTROLLED  
AND GENTLE CLOSE ACTION



SUITABLE FOR INSTALLATION  
WITH SIDE PANELS



COUNTERSUNK INTERIOR  
HINGES ON ALL HINGE DOORS  
WITH A FLUSH TO GLASS FINISH  
FOR EASE OF CLEANING



SUITABLE FOR INSTALLATION ON  
SHOWER TRAY OR WETROOM FLOOR



SUPERIOR DOUBLE WHEEL  
ROLLERS WITH A STAINLESS  
STEEL WHEEL BEARING AND  
WHEEL BRACKET COMPOSITION -  
QUICK RELEASE DESIGN



ALL ETO DOOR STYLES ARE  
FULLY REVERSIBLE FOR LEFT OR  
RIGHT HAND INSTALLATION



LIFETIME  
GUARANTEE



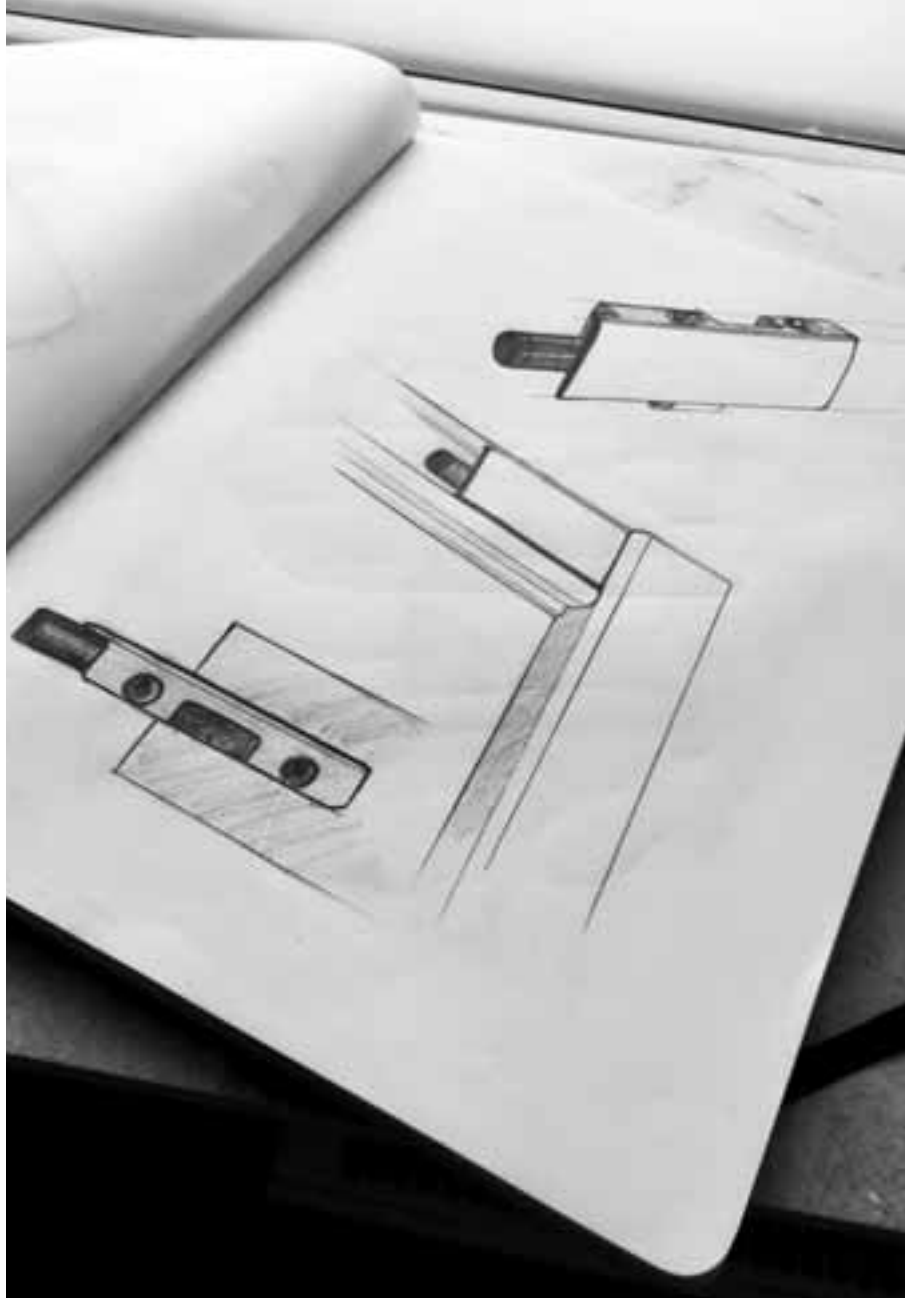

---

# DESIGN WITH PURPOSE



## MAGNETIC INFOLD LINKAGE SYSTEM

The ETO Infold door features a pioneering magnetic linkage system which ensures the smoothest of motion as the door functions. The solid metal linkage arm is bonded directly to the glass and provides for an ultra minimalist infold door aesthetic. This innovative design removes the need for magnetic seals, giving a beautifully seamless glass edge on the door.

## MAGNETIC CUSHION CLOSE DOOR SYSTEM

A concealed piston door close system gives ETO sliding doors a controlled and gentle close action. Double rollers with stainless steel ball bearings and a stainless steel wheel bracket design deliver an effortless sliding experience as the door glides along the magnetised rail.



## PATENTED CLICK FIT ASSEMBLY SYSTEM

With our installers in mind, Flair have designed ETO with a patented "Click Fit" Assembly System.

This revolutionary assembly mechanism is screw free and ensures each door can be installed easily and securely.

The tapered dovetail joint locks securely into position, giving a seamless connection between the vertical and horizontal profiles. This pioneering installation system ensures maximum structural integrity within every door and makes ETO the shower door of choice for the busiest of bathrooms.

(European Application No 19170695.1)



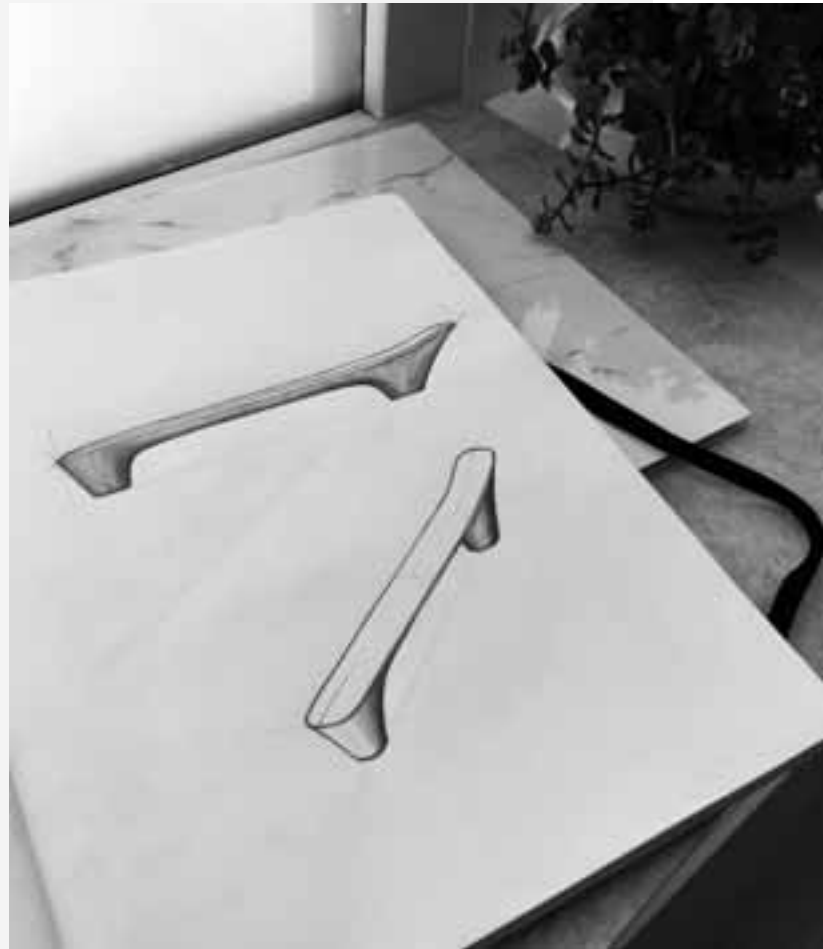

IDEA  
CONCEPT  
PROTOTYPE  
ETO

# INFOLD DOOR

SILVER

MATTE BLACK

The ETO Infold is the perfect blend of elegance with practical functionality.

This outward opening door protrudes minimally into the bathroom, saving on space. The unique Infold door design also affords generous access to the shower.

The ETO Infold features a pioneering magnetic linkage system which gives the door a perfectly smooth gliding action. This innovative design removes the need for magnetic seals on the glass, giving a beautifully seamless glass edge to the door.

As is standard across the ETO range, the Infold door is constructed from 8mm toughened safety glass with ClearVue hydrophobic coating. All interior fixings are fully concealed, making this shower enclosure as delightful internally as externally.

## DOOR SIZE OPTIONS

PRODUCT SIZE (mm)	ADJUSTMENT SIZE		ACCESS (mm)	CODE SILVER	CODE MATTE BLACK
	MIN (mm)	MAX (mm)			
700	650	690	496	ETOIF70SC	ETOIF70BC
760	710	750	556	ETOIF76SC	ETOIF76BC
800	750	790	596	ETOIF80SC	ETOIF80BC
900	850	890	696	ETOIF90SC	ETOIF90BC
1000	950	990	796	ETOIF100SC	ETOIF100BC

## SEMI FRAMED SIDE PANEL OPTIONS *(Includes Corner Profile)*

PRODUCT SIZE (mm)	ADJUSTMENT SIZE		CODE SILVER	CODE MATTE BLACK
	MIN (mm)	MAX (mm)		
700	660	680	ETOSP70SC	ETOSP70BC
760	720	740	ETOSP76SC	ETOSP76BC
800	760	780	ETOSP80SC	ETOSP80BC
900	860	880	ETOSP90SC	ETOSP90BC
1000	960	980	ETOSP100SC	ETOSP100BC
1100	1060	1080	ETOSP110SC	–
1200	1160	1180	ETOSP120SC	ETOSP120BC

**NOTE** – An ETO Infold installed with a side panel must be installed with the 10mm compensating profile supplied.

PRODUCT SIZE	CODE SILVER	CODE MATTE BLACK
10mm Compensating Wall Profile*	ETOCB10SC	ETOCB10BC
25mm Compensating Wall Profile	ETOCB25SC	ETOCB25BC

Infold Door is also suitable to be installed with an Inline Panel - For size options, please see below.  
\*10mm Compensating Wall Profile included with side panel

## INLINE PANEL OPTIONS

PRODUCT SIZE (mm)	CODE SILVER	CODE MATTE BLACK
150	ETOIL15SC	ETOIL15BC
200	ETOIL20SC	ETOIL20BC
300	ETOIL30SC	ETOIL30BC
400	ETOIL40SC	ETOIL40BC
450	ETOIL45SC	ETOIL45BC
500	ETOIL50SC	ETOIL50BC

**NOTE** – An ETO Inline Panel can be installed on each or both sides on the door with a compensating wall profile supplied.

### INFOLD - DOOR OPEN POSITION MEASUREMENTS

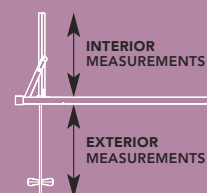

INFOLD DOOR SIZE	INTERIOR MEASUREMENT	EXTERIOR MEASUREMENT
700mm	250mm	292mm
760mm	250mm	352mm
800mm	250mm	392mm
900mm	357mm	386mm
1000mm	357mm	486mm

INFOLD DOOR WITH SIDE PANEL - MATTE BLACK





INFOLD DOOR IN  
ALCOVE - SILVER

- |   |   |  |  |  |   |  |
|---|---|--|--|--|---|--|
|  <p><b>2000mm</b><br/>HEIGHT</p>         |  <p><b>8mm</b><br/>TOUGHENED<br/>SAFETY<br/>GLASS</p>      |  <p><b>20mm</b><br/>PROFILE<br/>ADJUSTMENT</p>        |  <p><b>CRAFTED<br/>HANDLE DESIGN</b></p>                  |  <p><b>CLEARVUE<br/>GLASS COATING</b></p> |  <p><b>ULTRA CLEAR<br/>SEALS</b></p>           |  <p><b>SILVER &amp; BLACK<br/>OPTIONS<br/>AVAILABLE<br/>*SELECTED DOOR<br/>STYLES</b></p> |
|  <p><b>PRESS FIT<br/>SEAL DESIGN</b></p> |  <p><b>ULTRA SLIM<br/>CHROME PLATED<br/>COVER CAPS</b></p> |  <p><b>SEAMLESS<br/>INTERIOR<br/>COVER STRIPS</b></p> |  <p><b>SHOWER TRAY<br/>OR WETROOM<br/>APPLICATION</b></p> |  <p><b>REVERSIBLE</b></p>                 |  <p><b>PRE-ASSEMBLED<br/>PROFILE FRAME</b></p> |  <p><b>LIFETIME<br/>GUARANTEE</b></p>   |

## ETO BRUSHED COLLECTION

# INFOLD DOOR

BRUSHED BRASS

BRUSHED NICKEL

BRUSHED BRONZE

The ETO Infold is the perfect blend of elegance with practical functionality.

This outward opening door protrudes minimally into the bathroom, saving on space. The unique Infold door design also affords generous access to the shower:

The ETO Infold features a pioneering magnetic linkage system which gives the door a perfectly smooth gliding action. This innovative design removes the need for magnetic seals on the glass, giving a beautifully seamless glass edge to the door.

As is standard across the ETO range, the Infold door is constructed from 8mm toughened safety glass with ClearVue hydrophobic coating. All interior fixings are fully concealed, making this shower enclosure as delightful internally as externally.

## DOOR SIZE OPTIONS

PRODUCT SIZE (mm)	ADJUSTMENT SIZE		ACCESS (mm)	CODE	CODE	CODE
	MIN (mm)	MAX (mm)		BRUSHED BRASS	BRUSHED NICKEL	BRUSHED BRONZE
800	750	790	596	ETOIF80BRBC	ETOIF80BRNC	ETOIF80BRZC
900	850	890	696	ETOIF90BRBC	ETOIF90BRNC	ETOIF90BRZC
1000	950	990	796	ETOIF100BRBC	ETOIF100BRNC	ETOIF100BRZC

## SEMI FRAMED SIDE PANEL OPTIONS *(Includes Corner Profile)*

PRODUCT SIZE (mm)	ADJUSTMENT SIZE		CODE	CODE	CODE
	MIN (mm)	MAX (mm)	BRUSHED BRASS	BRUSHED NICKEL	BRUSHED BRONZE
700	660	680	ETOSP70BRBC	ETOSP70BRNC	ETOSP70BRZC
800	760	780	ETOSP80BRBC	ETOSP80BRNC	ETOSP80BRZC
900	860	880	ETOSP90BRBC	ETOSP90BRNC	ETOSP90BRZC
1000	960	980	ETOSP100BRBC	–	–

**NOTE** – An ETO Infold installed with a side panel must be installed with the 10mm compensating profile supplied.

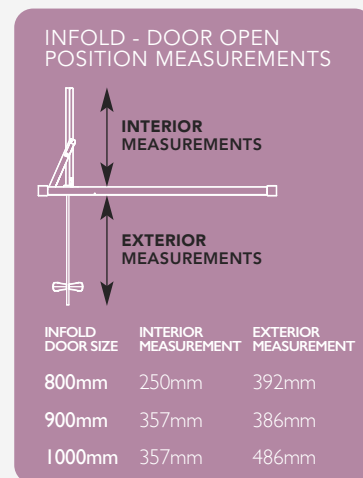

## COMPENSATING PROFILE OPTIONS

PRODUCT SIZE (mm)	CODE	CODE	CODE
	BRUSHED BRASS	BRUSHED NICKEL	BRUSHED BRONZE
10mm Compensating Wall Profile*	ETOCB10BRB	–	–
25mm Compensating Wall Profile	ETOCB25BRB	ETOCB25BRN	ETOCB25BRZ

Infold Door is also suitable to be installed with an Inline Panel - For size options, please see below.

\*10mm Compensating Wall Profile included with side panel.

## INLINE PANEL OPTIONS

PRODUCT SIZE (mm)	CODE	CODE	CODE
	BRUSHED BRASS	BRUSHED NICKEL	BRUSHED BRONZE
300	ETOIL30BRBC	ETOIL30BRNC	ETOIL30BRZC
400	ETOIL40BRBC	ETOIL40BRNC	ETOIL40BRZC

**NOTE** – An ETO Inline Panel can be installed on each or both sides on the Infold Door with compensating profile supplied.



INFOLD DOOR  
WITH SIDE PANEL -  
BRUSHED NICKEL



INFOLD DOOR  
WITH SIDE PANEL -  
BRUSHED BRONZE

**2000mm**  
HEIGHT

**8mm**  
TOUGHENED  
SAFETY  
GLASS

**20mm**  
PROFILE  
ADJUSTMENT

**11**  
CRAFTED  
HANDLE DESIGN

**CLEARVUE**  
GLASS COATING

**ULTRA CLEAR**  
SEALS

**PRESS FIT**  
SEAL DESIGN

**ULTRA SLIM**  
CHROME PLATED  
COVER CAPS

**SEAMLESS**  
INTERIOR  
COVER STRIPS

**SHOWER TRAY**  
OR WETROOM  
APPLICATION

**REVERSIBLE**

**PRE-ASSEMBLED**  
PROFILE FRAME

**LIFETIME**  
GUARANTEE

# HINGE DOOR

SILVER

MATTE BLACK

The stylish yet functional simplicity of the ETO Hinge door makes it the ideal choice for today's contemporary bathroom.

This 2 metre high door is supported by two precisely curved hinges that boast a flush to glass interior finish which allow for ease of cleaning. 8mm toughened safety glass is coated with ClearVue hydrophobic coating to resist the build up of unwanted grime and limescale.

The ETO Hinge door can be fitted independently in an alcove setting or with a dedicated ETO side panel of choice.

## DOOR SIZE OPTIONS

PRODUCT SIZE (mm)	ADJUSTMENT SIZE		ACCESS (mm)	CODE	CODE
	MIN (mm)	MAX (mm)		SILVER	MATTE BLACK
800	750	790	646	ETOHD80SC	ETOHD80BC
900	850	890	746	ETOHD90SC	ETOHD90BC
1000	950	990	846	ETOHD100SC	—

## SEMI FRAMED SIDE PANEL OPTIONS *(Includes Corner Profile)*

PRODUCT SIZE (mm)	ADJUSTMENT SIZE		CODE	CODE
	MIN (mm)	MAX (mm)	SILVER	MATTE BLACK
700	660	680	ETOSP70SC	ETOSP70BC
760	720	740	ETOSP76SC	ETOSP76BC
800	760	780	ETOSP80SC	ETOSP80BC
900	860	880	ETOSP90SC	ETOSP90BC
1000	960	980	ETOSP100SC	ETOSP100BC
1100	1060	1080	ETOSP110SC	—
1200	1160	1180	ETOSP120SC	ETOSP120BC

**NOTE** – An ETO Hinge Door installed with a side panel must be installed with the 10mm compensating profile supplied.

PRODUCT SIZE	CODE	CODE
	SILVER	MATTE BLACK
10mm Compensating Wall Profile*	ETOCB10SC	ETOCB10BC
25mm Compensating Wall Profile	ETOCB25SC	ETOCB25BC

Hinge Door is also suitable to be installed with an Inline Panel - For size options, please see below.  
\*10mm Compensating Wall Profile included with side panel

## INLINE PANEL OPTIONS

PRODUCT SIZE (mm)	CODE	CODE
	SILVER	MATTE BLACK
150	ETOIL15SC	ETOIL15BC
200	ETOIL20SC	ETOIL20BC
300	ETOIL30SC	ETOIL30BC
400	ETOIL40SC	ETOIL40BC
450	ETOIL45SC	ETOIL45BC
500	ETOIL50SC	ETOIL50BC

**NOTE** – An ETO Inline Panel can be installed on each or both sides on the door with a compensating wall profile supplied.



HINGE DOOR WITH SEMI FRAMED SIDE PANEL - SILVER





HINGE DOOR WITH INLINE PANEL -  
MATTE BLACK

-  **2000mm**  
HEIGHT
-  **8mm**  
TOUGHENED  
SAFETY  
GLASS
-  **20mm**  
PROFILE  
ADJUSTMENT
-  **CRAFTED**  
HANDLE DESIGN
-  **CLEARVUE**  
GLASS COATING
-  **ULTRA CLEAR**  
SEALS
-  **PRE-ASSEMBLED**  
PROFILE FRAME
-  **SILVER & BLACK**  
OPTIONS  
AVAILABLE  
\*SELECTED DOOR  
STYLES
-  **PRESS FIT**  
SEAL DESIGN
-  **ULTRA SLIM**  
CHROME PLATED  
COVER CAPS
-  **SEAMLESS**  
INTERIOR  
COVER STRIPS
-  **SHOWER TRAY**  
OR WETROOM  
APPLICATION
-  **REVERSIBLE**
-  **COUNTERSUNK**  
INTERIOR  
HINGES
-  **LIFETIME**  
GUARANTEE



HINGE DOOR WITH SEMI FRAMED  
SIDE PANEL - BRUSHED BRASS

- |   |   |  |  |  |  |  |
|---|---|--|--|--|--|--|
|  <p><b>2000mm</b><br/>HEIGHT</p>         |  <p><b>8mm</b><br/>TOUGHENED<br/>SAFETY<br/>GLASS</p>      |  <p><b>20mm</b><br/>PROFILE<br/>ADJUSTMENT</p>        |  <p><b>CRAFTED<br/>HANDLE DESIGN</b></p>                  |  <p><b>CLEARVUE<br/>GLASS COATING</b></p> |  <p><b>ULTRA CLEAR<br/>SEALS</b></p>  |  <p><b>MAGNETIC<br/>CUSHION CLOSE<br/>DOOR SYSTEM</b></p> |
|  <p><b>PRESS FIT<br/>SEAL DESIGN</b></p> |  <p><b>ULTRA SLIM<br/>CHROME PLATED<br/>COVER CAPS</b></p> |  <p><b>SEAMLESS<br/>INTERIOR<br/>COVER STRIPS</b></p> |  <p><b>SHOWER TRAY<br/>OR WETROOM<br/>APPLICATION</b></p> |  <p><b>REVERSIBLE</b></p>                 |  <p><b>LIFETIME<br/>GUARANTEE</b></p> |  |

## ETO BRUSHED COLLECTION

# HINGE DOOR

BRUSHED BRASS

BRUSHED NICKEL

BRUSHED BRONZE

The stylish yet functional simplicity of the ETO Hinge door makes it the ideal choice for today's contemporary bathroom.

This 2 metre high door is supported by two precisely curved hinges that boast a flush to glass interior finish which allow for ease of cleaning. 8mm toughened safety glass is coated with ClearVue hydrophobic coating to resist the build up of unwanted grime and limescale.

The ETO Hinge door can be fitted independently in an alcove setting or with a dedicated ETO side panel of choice.

## DOOR SIZE OPTIONS

PRODUCT SIZE (mm)	ADJUSTMENT SIZE		ACCESS (mm)	CODE	CODE	CODE
	MIN (mm)	MAX (mm)		BRUSHED BRASS	BRUSHED NICKEL	BRUSHED BRONZE
800	750	790	596	ETOHD80BRBC	ETOHD80BRNC	ETOHD80BRZC
900	850	890	646	ETOHD90BRBC	ETOHD90BRNC	ETOHD90BRZC
1000	950	990	846	ETOHD100BRBC	ETOHD100BRNC	ETOHD100BRZC

## SEMI FRAMED SIDE PANEL OPTIONS *(Includes Corner Profile)*

PRODUCT SIZE (mm)	ADJUSTMENT SIZE		CODE	CODE	CODE
	MIN (mm)	MAX (mm)	BRUSHED BRASS	BRUSHED NICKEL	BRUSHED BRONZE
700	660	680	ETOSP70BRBC	ETOSP70BRNC	ETOSP70BRZC
800	760	780	ETOSP80BRBC	ETOSP80BRNC	ETOSP80BRZC
900	860	880	ETOSP90BRBC	ETOSP90BRNC	ETOSP90BRZC
1000	960	980	ETOSP100BRBC	–	–

**NOTE** – An ETO Hinge Door installed with a side panel must be installed with the 10mm compensating profile supplied.

## COMPENSATING PROFILE OPTIONS

PRODUCT SIZE (mm)	ADJUSTMENT SIZE		CODE	CODE	CODE
	MIN (mm)	MAX (mm)	BRUSHED BRASS	BRUSHED NICKEL	BRUSHED BRONZE
10mm Compensating Wall Profile*			ETOCB10BRB	–	–
25mm Compensating Wall Profile			ETOCB25BRB	ETOCB25BRN	ETOCB25BRZ

Hinge Door is also suitable to be installed with an Inline Panel - For size options, please see below.

\*10mm Compensating Wall Profile included with side panel.

## INLINE PANEL OPTIONS

PRODUCT SIZE (mm)	CODE	CODE	CODE
	BRUSHED BRASS	BRUSHED NICKEL	BRUSHED BRONZE
300	ETOIL30BRBC	ETOIL30BRNC	ETOIL30BRZC
400	ETOIL40BRBC	ETOIL40BRNC	ETOIL40BRZC

Note – An ETO Inline Panel can be installed on each or both sides on the Hinge Door with compensating profile supplied.





HINGE & INLINE DOOR WITH SEMI FRAMED SIDE PANEL - SILVER



HINGE AND INLINE DOOR WITH INLINE PANEL - MATTE BLACK

SOFTLY CURVED  
ETO HINGE  
DESIGN WITH  
COUNTERSUNK  
INTERIOR FINISH



- 2000mm HEIGHT
- 8mm TOUGHENED SAFETY GLASS
- 20mm PROFILE ADJUSTMENT
- CRAFTED HANDLE DESIGN
- CLEARVUE GLASS COATING
- ULTRA CLEAR SEALS
- COUNTERSUNK INTERIOR HINGES
- PRESS FIT SEAL DESIGN
- ULTRA SLIM CHROME PLATED COVER CAPS
- SEAMLESS INTERIOR COVER STRIPS
- SHOWER TRAY OR WETROOM APPLICATION
- REVERSIBLE
- SILVER & BLACK OPTIONS AVAILABLE \*SELECTED DOOR STYLES
- LIFETIME GUARANTEE

# HINGE & INLINE DOOR

SILVER

MATTE BLACK

The impressive ETO Hinge and Inline door is the perfect option for those larger luxurious bathroom spaces.

The flawless semi framed profiles give this door a robust feel, whilst the crafted ETO handle provides optimal functionality with its integrated towel hook design.

Designed with purpose, the softly curved hinges are countersunk into the glass and their flush interior finish allows for ease of cleaning. As is standard across the ETO range, this door comes with ClearVue glass coating which repels grime and limescale build up.

## DOOR SIZE OPTIONS

PRODUCT SIZE (mm)	ADJUSTMENT SIZE		ACCESS (mm)	CODE	CODE
	MIN (mm)	MAX (mm)		SILVER	MATTE BLACK
1100	1050	1090	725	ETOHD110SC	–
1200	1150	1190	725	ETOHD120SC	ETOHD120BC
1300	1250	1290	725	ETOHD130SC	–
1400	1350	1390	725	ETOHD140SC	ETOHD140BC
1500	1450	1490	725	ETOHD150SC	–
1600	1550	1590	725	ETOHD160SC	–

## SEMI FRAMED SIDE PANEL OPTIONS *(Includes Corner Profile)*

PRODUCT SIZE (mm)	ADJUSTMENT SIZE		CODE	CODE
	MIN (mm)	MAX (mm)	SILVER	MATTE BLACK
700	660	680	ETOSP70SC	ETOSP70BC
760	720	740	ETOSP76SC	ETOSP76BC
800	760	780	ETOSP80SC	ETOSP80BC
900	860	880	ETOSP90SC	ETOSP90BC
1000	960	980	ETOSP100SC	ETOSP100BC
1100	1060	1080	ETOSP110SC	–
1200	1160	1180	ETOSP120SC	ETOSP120BC



**NOTE** – An ETO Hinge & Inline Door installed with a side panel must be installed with the 10mm compensating profile supplied.

PRODUCT SIZE	CODE	CODE
	SILVER	MATTE BLACK
10mm Compensating Wall Profile*	ETOCB10SC	ETOCB10BC
25mm Compensating Wall Profile	ETOCB25SC	ETOCB25BC

Hinge & Inline Door is also suitable to be installed with an Inline Panel - For size options, please see below.

\*10mm Compensating Wall Profile included with side panel

## INLINE PANEL OPTIONS

PRODUCT SIZE (mm)	CODE	CODE
	SILVER	MATTE BLACK
150	ETOIL15SC	ETOIL15BC
200	ETOIL20SC	ETOIL20BC
300	ETOIL30SC	ETOIL30BC
400	ETOIL40SC	ETOIL40BC
450	ETOIL45SC	ETOIL45BC
500	ETOIL50SC	ETOIL50BC

**NOTE** – An ETO Inline Panel can be installed on each or both sides on the door with a compensating wall profile supplied.

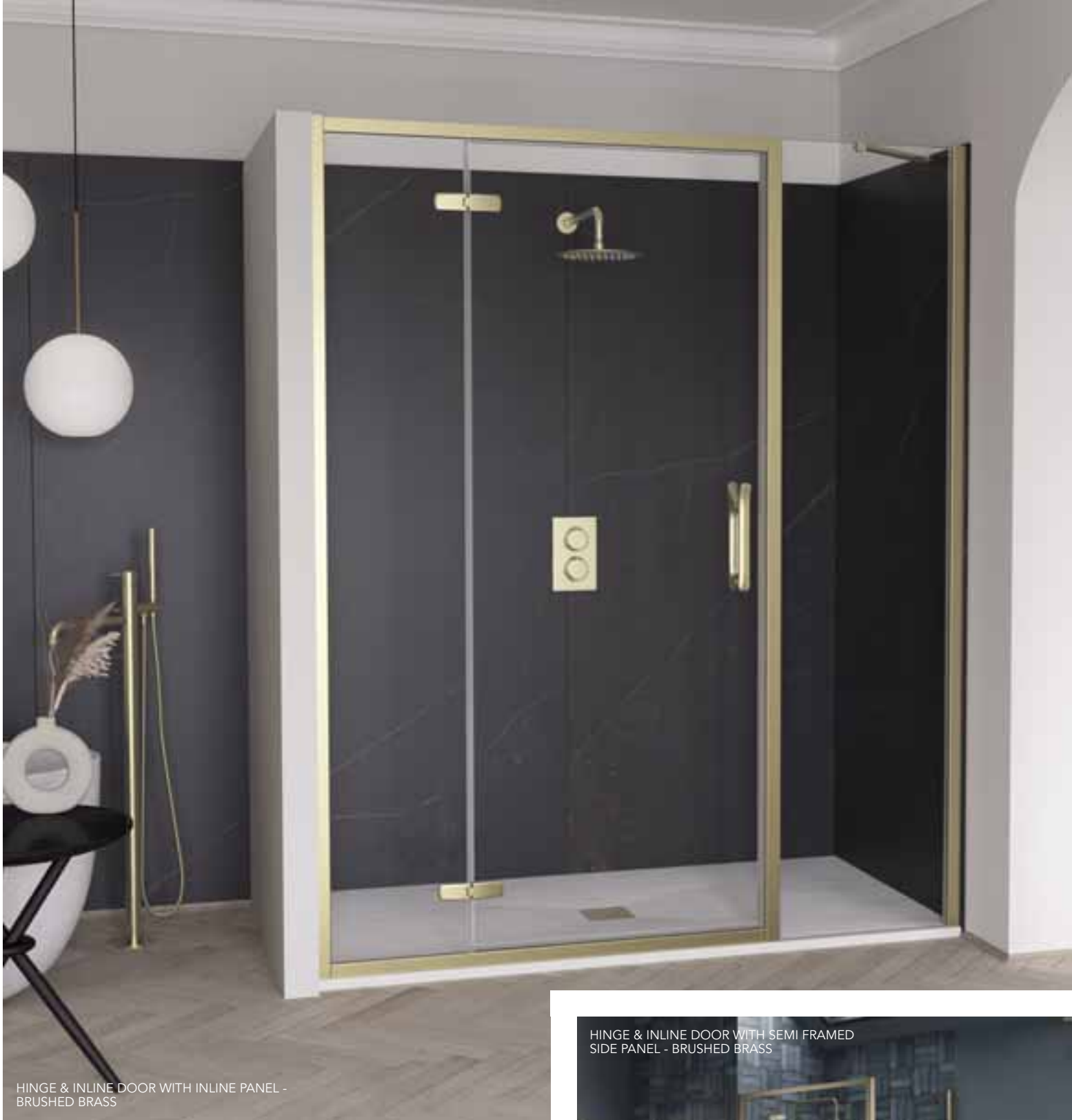

HINGE & INLINE DOOR WITH INLINE PANEL - BRUSHED BRASS

HINGE & INLINE DOOR WITH SEMI FRAMED SIDE PANEL - BRUSHED BRASS

**The impressive ETO Hinge and Inline door is the perfect option for those larger luxurious bathroom spaces.**

The flawless semi framed profiles give this door a robust feel, whilst the crafted ETO handle provides optimal functionality with its integrated towel hook design.

Designed with purpose, the softly curved hinges are countersunk into the glass and their flush interior finish allows for ease of cleaning. As is standard across the ETO range, this door comes with ClearVue glass coating which repels grime and limescale build up.

## ETO BRUSHED COLLECTION

# HINGE & INLINE DOOR

BRUSHED BRASS

BRUSHED NICKEL

BRUSHED BRONZE



### DOOR SIZE OPTIONS

PRODUCT SIZE (mm)	ADJUSTMENT SIZE		ACCESS (mm)	CODE	CODE	CODE
	MIN (mm)	MAX (mm)		BRUSHED BRASS	BRUSHED NICKEL	BRUSHED BRONZE
1200	1150	1190	725	ETOHD120BRBC	ETOHD120BRNC	ETOHD120BRZC
1400	1350	1390	725	ETOHD140BRBC	ETOHD140BRNC	ETOHD140BRZC

### SEMI FRAMED SIDE PANEL OPTIONS *(Includes Corner Profile)*

PRODUCT SIZE (mm)	ADJUSTMENT SIZE		CODE	CODE	CODE
	MIN (mm)	MAX (mm)	BRUSHED BRASS	BRUSHED NICKEL	BRUSHED BRONZE
700	660	680	ETOSP70BRBC	ETOSP70BRNC	ETOSP70BRZC
800	760	780	ETOSP80BRBC	ETOSP80BRNC	ETOSP80BRZC
900	860	880	ETOSP90BRBC	ETOSP90BRNC	ETOSP90BRZC
1000	960	980	ETOSP100BRBC	–	–

**NOTE** – An ETO Hinge & Inline Door installed with a side panel must be installed with the 10mm compensating profile supplied.

### COMPENSATING PROFILE OPTIONS

PRODUCT SIZE (mm)	CODE	CODE	CODE
	BRUSHED BRASS	BRUSHED NICKEL	BRUSHED BRONZE
10mm Compensating Wall Profile*	ETOCB10BRB	–	–
25mm Compensating Wall Profile	ETOCB25BRB	ETOCB25BRN	ETOCB25BRZ

Hinge & Inline Door is also suitable to be installed with an Inline Panel - For size options, please see below.

\*10mm Compensating Wall Profile included with side panel.

### INLINE PANEL OPTIONS

PRODUCT SIZE (mm)	CODE	CODE	CODE
	BRUSHED BRASS	BRUSHED NICKEL	BRUSHED BRONZE
300	ETOIL30BRBC	ETOIL30BRNC	ETOIL30BRZC
400	ETOIL40BRBC	ETOIL40BRNC	ETOIL40BRZC

Note – An ETO Inline Panel can be installed on each or both sides on the Hinge Door with compensating profile supplied.



# SLIDING DOOR

SILVER

MATTE BLACK

## DOOR SIZE OPTIONS

PRODUCT SIZE (mm)	ADJUSTMENT SIZE		ACCESS (mm)	CODE	CODE
	MIN (mm)	MAX (mm)		SILVER	MATTE BLACK
1000	950	990	370	ETOSA100SC	–
1100	1050	1090	420	ETOSA110SC	ETOSA110BC
1200	1150	1190	470	ETOSA120SC	ETOSA120BC
1300	1250	1290	520	ETOSA130SC	–
1400	1350	1390	520	ETOSA140SC	ETOSA140BC
1500	1450	1490	570	ETOSA150SC	ETOSA150BC
1600	1550	1590	570	ETOSA160SC	–
1700	1650	1690	570	ETOSA170SC	–
1800	1750	1790	570	ETOSA180SC	–



SLIDING DOOR WITH SEMI FRAMED SIDE PANEL - MATTE BLACK

## SEMI FRAMED SIDE PANEL OPTIONS *(Includes Corner Profile)*

PRODUCT SIZE (mm)	ADJUSTMENT SIZE		CODE	CODE
	MIN (mm)	MAX (mm)	SILVER	MATTE BLACK
700	660	680	ETOSP70SC	ETOSP70BC
760	720	740	ETOSP76SC	ETOSP76BC
800	760	780	ETOSP80SC	ETOSP80BC
900	860	880	ETOSP90SC	ETOSP90BC
1000	960	980	ETOSP100SC	ETOSP100BC
1100	1060	1080	ETOSP110SC	–
1200	1160	1180	ETOSP120SC	ETOSP120BC

**NOTE** – An ETO Sliding door installed with a side panel must be installed with the 10mm compensating profile supplied.

## NEW - FRAMELESS SIDE PANELS *(Suitable only for Sliding Door)*

PRODUCT SIZE (mm)	ADJUSTMENT SIZE		CODE	CODE
	MIN (mm)	MAX (mm)	SILVER	MATTE BLACK
700	660	680	ETOFSP70SC	ETOFSP70BC
760	720	740	ETOFSP76SC	ETOFSP76BC
800	760	780	ETOFSP80SC	ETOFSP80BC
900	860	880	ETOFSP90SC	ETOFSP90BC
1000	960	980	ETOFSP100SC	ETOFSP100BC
1200	1160	1180	ETOFSP120SC	ETOFSP120BC

PRODUCT SIZE	CODE	CODE
	SILVER	MATTE BLACK
10mm Compensating Wall Profile*	ETOCB10SC	ETOCB10BC
25mm Compensating Wall Profile	ETOCB25SC	ETOCB25BC

Sliding Door is also suitable to be installed with an Inline Panel - For size options, please see below.  
\*10mm Compensating Wall Profile included with side panel



SLIDING DOOR IN ALCOVE - SILVER

## INLINE PANEL OPTIONS

PRODUCT SIZE (mm)	CODE	CODE
	SILVER	MATTE BLACK
150	ETOIL15SC	ETOIL15BC
200	ETOIL20SC	ETOIL20BC
300	ETOIL30SC	ETOIL30BC
400	ETOIL40SC	ETOIL40BC
450	ETOIL45SC	ETOIL45BC
500	ETOIL50SC	ETOIL50BC

**NOTE** – An ETO Inline Panel can be installed on each or both sides on the door with a compensating wall profile supplied.



With minimalist profiles surrounding 8mm toughened safety glass, the ETO Sliding Door is designed with long lasting durability in mind.

The sliding door glass is guided by stainless steel wheel brackets which provide an effortlessly smooth experience. The magnetic cushion close mechanism ensures a controlled and gentle action as the door opens and closes.

The curvature of the crafted ETO handle feels beautifully precise in hand, whilst also doubling up on functionality with its integrated towel hook design.



SLIDING DOOR WITH FRAMELESS SIDE PANEL - SILVER

<p><b>2000mm</b> HEIGHT</p>	<p><b>8mm</b> TOUGHENED SAFETY GLASS</p>	<p><b>20mm</b> PROFILE ADJUSTMENT</p>	<p>CRAFTED HANDLE DESIGN</p>	<p>CLEARVUE GLASS COATING</p>	<p>ULTRA CLEAR SEALS</p>	<p>MAGNETIC CUSHION CLOSE DOOR SYSTEM</p>	<p>SILVER &amp; BLACK OPTIONS AVAILABLE *SELECTED DOOR STYLES</p>
<p>PRESS FIT SEAL DESIGN</p>	<p>ULTRA SLIM CHROME PLATED COVER CAPS</p>	<p>SEAMLESS INTERIOR COVER STRIPS</p>	<p>SHOWER TRAY OR WETROOM APPLICATION</p>	<p>REVERSIBLE</p>	<p>LIFETIME GUARANTEE</p>	<p><b>CLICK FIT</b> ASSEMBLY SYSTEM PATENTED</p>	

## ETO BRUSHED COLLECTION

# SLIDING DOOR

BRUSHED BRASS

BRUSHED NICKEL

BRUSHED BRONZE

With minimalist profiles surrounding 8mm toughened safety glass, the ETO Sliding is designed with long lasting durability in mind.

The sliding door glass is guided by stainless steel wheel brackets which provide an effortlessly smooth experience. The magnetic cushion close mechanism ensures a controlled and gentle action as the door opens and closes.

The curvature of the crafted ETO handle feels beautifully precise in hand, whilst also doubling up on functionality with its integrated towel hook design.



## DOOR SIZE OPTIONS

PRODUCT SIZE (mm)	ADJUSTMENT SIZE		ACCESS (mm)	CODE	CODE	CODE
	MIN (mm)	MAX (mm)		BRUSHED BRASS	BRUSHED NICKEL	BRUSHED BRONZE
1100	1050	1090	420	ETOSA110BRBC	ETOSA110BRNC	–
1200	1150	1190	470	ETOSA120BRBC	ETOSA120BRNC	ETOSA120BRZC
1400	1350	1390	520	ETOSA140BRBC	ETOSA140BRNC	ETOSA140BRZC
1500	1450	1490	570	ETOSA150BRBC	ETOSA150BRNC	ETOSA150BRZC

## SEMI FRAMED SIDE PANEL OPTIONS *(Includes Corner Profile)*

PRODUCT SIZE (mm)	ADJUSTMENT SIZE		CODE	CODE	CODE
	MIN (mm)	MAX (mm)	BRUSHED BRASS	BRUSHED NICKEL	BRUSHED BRONZE
700	660	680	ETOSP70BRBC	ETOSP70BRNC	ETOSP70BRZC
800	760	780	ETOSP80BRBC	ETOSP80BRNC	ETOSP80BRZC
900	860	880	ETOSP90BRBC	ETOSP90BRNC	ETOSP90BRZC
1000	960	980	ETOSP100BRBC	–	–

**NOTE** – An ETO Sliding Door installed with a side panel must be installed with the 10mm compensating profile supplied.

## COMPENSATING PROFILE OPTIONS

PRODUCT SIZE (mm)	ADJUSTMENT SIZE		CODE	CODE	CODE
	MIN (mm)	MAX (mm)	BRUSHED BRASS	BRUSHED NICKEL	BRUSHED BRONZE
10mm Compensating Wall Profile*			ETOCB10BRB	–	–
25mm Compensating Wall Profile			ETOCB25BRB	ETOCB25BRN	ETOCB25BRZ

Sliding Door is also suitable to be installed with an Inline Panel - For size options, please see below.

\*10mm Compensating Wall Profile included with side panel.

## INLINE PANEL OPTIONS

PRODUCT SIZE (mm)	CODE	CODE	CODE
	BRUSHED BRASS	BRUSHED NICKEL	BRUSHED BRONZE
300	ETOIL30BRBC	ETOIL30BRNC	ETOIL30BRZC
400	ETOIL40BRBC	ETOIL40BRNC	ETOIL40BRZC

**NOTE** – An ETO Inline Panel can be installed on each or both sides on the Infold Door with compensating profile supplied.

SLIDING DOOR WITH SIDE PANEL - BRUSHED NICKEL



SLIDING DOOR IN ALCOVE - BRUSHED NICKEL



SLIDING DOOR WITH SIDE PANEL - BRUSHED BRONZE

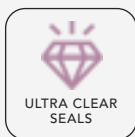

# ONE DOOR QUADRANT

SILVER

MATTE BLACK

The ETO One Door Quadrant is perfectly shaped to make the most out of a corner bathroom space.

Ideal for any bathroom, the innovative magnetic cushion close feature ensures a smooth rolling door action on this quadrant. The double wheel rollers have a stainless steel composition for longevity and their quick release design allow for ease of cleaning.

ClearVue hydrophobic coating on the 8mm toughened safety glass resists the build up of grime and limescale on the glass surface. The centrally positioned door opening provides easy access to the shower space and is considerate of furniture positioning within the bathroom.

## DOOR SIZE OPTIONS

PRODUCT SIZE (mm)	ADJUSTMENT SIZE		ACCESS (mm)	CODE	CODE
	MIN (mm)	MAX (mm)		SILVER	MATTE BLACK
800	770	790	440	ETOOCQ80SC	-
900	870	890	484	ETOOCQ90SC	ETOOCQ90BC
1000	970	990	484	ETOOCQ100SC	ETOOCQ100BC



QUICK RELEASE ROLLER DESIGN



CRAFTED ETO HANDLE WITH INTEGRATED ROBE HOOK FEATURE



 2000mm HEIGHT	 8mm TOUGHENED SAFETY GLASS	 20mm PROFILE ADJUSTMENT	 CRAFTED HANDLE DESIGN	 CLEARVUE GLASS COATING	 ULTRA CLEAR SEALS	 MAGNETIC CUSHION CLOSE DOOR SYSTEM
 PRESS FIT SEAL DESIGN	 ULTRA SLIM CHROME PLATED COVER CAPS	 SEAMLESS INTERIOR COVER STRIPS	 SHOWER TRAY OR WETROOM APPLICATION	 REVERSIBLE	 SILVER & BLACK OPTIONS AVAILABLE *SELECTED DOOR STYLES	 LIFETIME GUARANTEE



ONE DOOR QUADRANT - SILVER



ONE DOOR  
QUADRANT  
MATTE  
BLACK

# ONE DOOR OFFSET QUADRANT

SILVER

MATTE BLACK

The ETO One Door Offset Quadrant is perfectly shaped to make the most out of a corner bathroom space.

Ideal for larger bathrooms, the innovative magnetic cushion close feature ensures a smooth rolling door action on this offset quadrant. The double wheel rollers have a stainless steel composition for longevity and their quick release design allow for ease of cleaning.

ClearVue hydrophobic coating on the 8mm toughened safety glass resists the build up of grime and limescale on the glass surface. The centrally positioned door opening provides easy access to the shower space and is considerate of furniture positioning within the bathroom.

## DOOR SIZE OPTIONS

PRODUCT SIZE (mm)	ADJUSTMENT SIZE		ACCESS (mm)	CODE	CODE
	MIN (mm)	MAX (mm)		SILVER	MATTE BLACK
<b>1000 x 800</b> Long Side Opening	770-970	790-990	440	ETOOCQ100X80SCL	ETOOCQ100X80BCL
<b>1200 x 800</b> Long Side Opening	770-1170	790-1190	440	ETOOCQ120X80SCL	ETOOCQ120X80BCL
<b>1200 x 900</b> Long Side Opening	870-1170	890-1190	484	ETOOCQ120X90SCL	ETOOCQ120X90BCL



QUICK RELEASE ROLLER DESIGN



CRAFTED ETO HANDLE WITH INTEGRATED ROBE HOOK FEATURE



 <b>2000mm</b> HEIGHT	 <b>8mm</b> TOUGHENED SAFETY GLASS	 <b>20mm</b> PROFILE ADJUSTMENT	 CRAFTED HANDLE DESIGN	 CLEARVUE GLASS COATING	 ULTRA CLEAR SEALS	 MAGNETIC CUSHION CLOSE DOOR SYSTEM
 PRESS FIT SEAL DESIGN	 ULTRA SLIM CHROME PLATED COVER CAPS	 SEAMLESS INTERIOR COVER STRIPS	 SHOWER TRAY OR WETROOM APPLICATION	 REVERSIBLE	 SILVER & BLACK OPTIONS AVAILABLE *SELECTED DOOR STYLES	 LIFETIME GUARANTEE



ONE DOOR OFFSET QUADRANT - MATTE BLACK



ONE DOOR OFFSET QUADRANT - SILVER

## ETO BRUSHED COLLECTION

# ONE DOOR QUADRANT & OFFSET QUADRANT

BRUSHED BRASS

BRUSHED NICKEL

BRUSHED BRONZE

The ETO One Door Quadrant and Offset Quadrant are perfectly shaped to make the most out of a corner bathroom space.

Ideal for larger bathrooms, the innovative magnetic cushion close feature ensures a smooth rolling door action on this offset quadrant. The double wheel rollers have a stainless steel composition for longevity and their quick release design allow for ease of cleaning.

ClearVue hydrophobic coating on the 8mm toughened safety glass resists the build up of grime and limescale on the glass surface. The centrally positioned door opening provides easy access to the shower space and is considerate of furniture positioning within the bathroom.

## DOOR SIZE OPTIONS

PRODUCT SIZE (mm)	ADJUSTMENT SIZE		ACCESS (mm)	CODE	CODE	CODE
	MIN (mm)	MAX (mm)		BRUSHED BRASS	BRUSHED NICKEL	BRUSHED BRONZE
900	870	890	484	ETOOCQ90BRBC	ETOOCQ90BRNC	ETOOCQ90BRZC
1000x800*	770-970	790-990	440	ETOOCQ100X80BRBCL	-	-
1200x800*	770-790	1170-1190	440	ETOOCQ120X80BRBCL	ETOOCQ120X80BRNCL	ETOOCQ120X80BRZCL
1200x900*	870-1170	890-1190	484	ETOOCQ120X90BRBCL	ETOOCQ120X90BRNCL	ETOOCQ120X90BRZCL

\*Long Side Opening



CRAFTED ETO HANDLE WITH INTEGRATED ROBE HOOK FEATURE







ONE DOOR OFFSET QUADRANT - BRUSHED BRONZE



ONE DOOR QUADRANT - BRUSHED BRASS



TWO DOOR QUADRANT - SILVER

# TWO DOOR QUADRANT

SILVER

Perfect for the every day, the gently curved detailing of this stylish Two Door Quadrant exudes contemporary elegance.

The magnetic cushion close door system brings both sliding doors to a controlled and gentle stop. The 8mm curved glass features ClearVue glass coating which repels against grime and limescale.

Superior quality double wheel rollers have a quick release design and are supported by stainless steel components, promising functional longevity in the busy bathroom environment.

## DOOR SIZE OPTIONS

PRODUCT SIZE (mm)	ADJUSTMENT SIZE		ACCESS (mm)	CODE - SILVER
	MIN (mm)	MAX (mm)		
900	870	890	528	ETOCQ90SC



SUPERIOR DOUBLE WHEEL ROLLER SYSTEM



CRAFTED ETO HANDLE WITH INTEGRATED ROBE HOOK FEATURE



# TWO DOOR OFFSET QUADRANT

SILVER

With generous proportions, the ETO Two Door Offset Quadrant is a much favoured corner shower door choice for many discerning homeowners.

The magnetic cushion close door system brings this door to a controlled and gentle stop. The impressive 8mm curved glass features ClearVue hydrophobic coating which repels against grime and limescale.

The sleek yet sturdy metal profiles give this door a robust feel while its gently curved detailing captures the essence of contemporary elegance.

## DOOR SIZE OPTIONS

PRODUCT SIZE (mm)	ADJUSTMENT SIZE MIN (mm)	MAX (mm)	(mm)	ACCESS SILVER
1100 x 800	770 - 1070	790 - 1090	458	ETOCQ80X110SC
1100 x 900	870 - 1070	890 - 1090	528	ETOCQ90X110SC
1200 x 800	770 - 1170	790 - 1190	458	ETOCQ80X120SC
1200 x 900	870 - 1170	890 - 1190	528	ETOCQ90X120SC



QUICK RELEASE  
BOTTOM ROLLERS



MAGNETIC CUSHION  
CLOSE DOOR SYSTEM

**NOTE** – Dedicated 1100 x 800mm and 1100 x 900mm offset quadrant slimline shower trays now available.



 2000mm HEIGHT	 8mm TOUGHENED SAFETY GLASS	 20mm PROFILE ADJUSTMENT	 CRAFTED HANDLE DESIGN	 CLEARVUE GLASS COATING	 ULTRA CLEAR SEALS	
 PRESS FIT SEAL DESIGN	 ULTRA SLIM CHROME PLATED COVER CAPS	 SEAMLESS INTERIOR COVER STRIPS	 SHOWER TRAY OR WETROOM APPLICATION	 REVERSIBLE	 MAGNETIC CUSHION CLOSE DOOR SYSTEM	 LIFETIME GUARANTEE





TWO DOOR OFFSET QUADRANT - SILVER



CORNER ENTRY - SILVER

# CORNER ENTRY

SILVER

The ETO Corner Entry boasts contemporary clean lines and a sturdy semi frameless design. The two door corner sliding configuration make the corner entry an ideal choice for the bathroom where space is limited.

The flush finish on the corner brackets provides for a truly seamless door aesthetic. Quick release double rollers ensure ease of cleaning while the magnetic cushion close system brings this door to a controlled and gentle stop.

Superior magnetic seals ensure watertightness and give a positive close action when both doors are drawn together.

## DOOR SIZE OPTIONS

PRODUCT SIZE (mm)	ADJUSTMENT SIZE		ACCESS (mm)	CODE - SILVER
	MIN (mm)	MAX (mm)		
800	770	790	392	ETOCE80SC
900	870	890	462	ETOCE90SC



ETO CORNER ENTRY HANDLE DESIGN



SLEEK FLUSH CORNER BRACKET DESIGN



**CLICK FIT**  
ASSEMBLY SYSTEM  
PATENT PENDING





## DESIGN AWARD

Flair are proud to have received the **Good Design** Award accolade in recognition of the ILI shower door collection.

The **Good Design** Award is a seal of global design excellence and a testimony to our passion for product quality and innovation.



## PATENTED CLICK FIT ASSEMBLY SYSTEM



This screw free assembly mechanism revolutionises the way ILI shower doors are fitted, reducing assembly time dramatically for installers.



EXPLORE  
ILI



ILI

FRAMED 6mm  
SHOWER ENCLOSURE  
COLLECTION

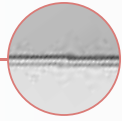

SILVER\*

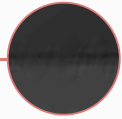

MATTE BLACK

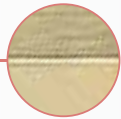

BRUSHED BRASS

# FINISHES

S - Silver\*  
B - Matte Black  
BRB - Brushed Brass

\* Baby IJI available in Silver only..

# THE ILI<sup>®</sup> COLLECTION

**Embrace everyday adventure with ILI.**

ILI is a fusion of original style and practical affordability. Crafted from 6mm glass, the unique handle features a cleverly integrated towel hook. The minimalist profiles and neatly curved hinges give simple, clean lines to the door aesthetic.

Each sliding door features a silent wheel track system while clearvue coating ensuring the shower door glass remains sparkling clean.

---

# ILI<sup>®</sup> VISIONARY INNOVATIONS

DOUBLE WHEEL  
ROLLERS GLIDE  
ALONG AN  
INNOVATIVE  
SILENT WHEEL  
TRACK SYSTEM





UNIQUELY CRAFTED ILI HANDLE  
WITH INTEGRATED ROBE HOOK



EXTERIOR HINGE VIEW



INTERIOR HINGE VIEW

SOFTLY CURVED  
ILI HINGE DESIGN

---

TECHNICAL  
INNOVATIONS



PATENTED  
CLICK FIT SYSTEM



ULTRA CLEAR  
PVC BOTTOM SEAL



SILENT WHEEL  
TRACK

# ILI<sup>®</sup> FUNCTIONAL DETAILS



1950MM HIGH  
SHOWER DOORS



VISUALLY ATTRACTIVE  
ULTRA CLEAR PVC DOOR SEALS



6MM TOUGHENED  
SAFETY GLASS THICKNESS,  
CERTIFIED TO EN12150



SEAMLESS INTERIOR  
COVER STRIPS CONCEAL ALL  
FIXATION POINTS INTERNALLY



25MM ADJUSTMENT ON  
EACH WALL PROFILE



INNOVATIVE PRESS FIT SEAL DESIGN  
FOR EASE OF INSTALLATION



PRECISELY CRAFTED SOLID CHROME  
PLATED ILI HANDLES THAT FEATURE  
AN INTEGRATED ROBE HOOK DESIGN



PRE ASSEMBLED DOOR FRAME  
ON BIFOLD & HINGE DOOR -  
FOR EASE OF INSTALLATION



CLEARVUE IS A HYDROPHOBIC  
GLASS COATING THAT RESISTS  
THE BUILD UP OF LIMESCALE AND  
GRIME ON THE GLASS SURFACE



SUITABLE FOR INSTALLATION  
WITH SIDE PANELS



SILENT WHEEL  
ROLLER MECHANISM



ULTRA SLIM COVER CAP  
DESIGN FOR A SLEEK AND  
MODERN DOOR AESTHETIC



SUPERIOR QUICK RELEASE  
DOUBLE WHEEL ROLLERS WITH  
STAINLESS STEEL BEARINGS



LIFETIME  
GUARANTEE



ALL ILI DOOR STYLES ARE  
FULLY REVERSIBLE FOR LEFT OR  
RIGHT HAND INSTALLATION



SUITABLE FOR  
WETROOM AND  
SHOWER TRAY  
INSTALLATION



---

# DESIGN WITH PURPOSE



## PATENTED CLICK FIT ASSEMBLY SYSTEM

With our installers in mind, Flair have designed ILLI with a patented "Click Fit" Assembly System.

This revolutionary assembly mechanism is screw free and ensures each door can be installed easily and securely.

The tapered dovetail joint locks securely into position, giving a seamless connection between the vertical and horizontal profiles. This pioneering installation system ensures maximum structural integrity within every door and makes ILLI the shower door of choice for the busiest of bathrooms.

(European Patent No 3730017)

## MAGNETIC BIFOLD SYSTEM

The ILLI Bifold door features an aesthetically pleasing functional magnetic system which ensure the smoothest of motion as the door functions. The beautifully curved hinge aligns with the design of ILLI.

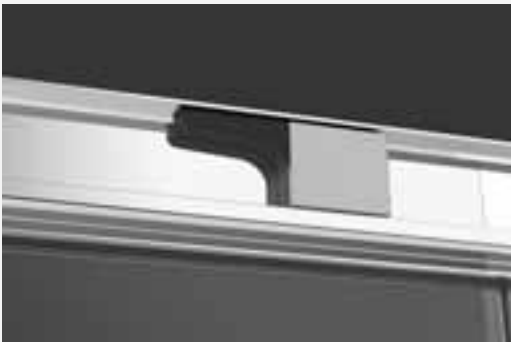

## CONCEALED LONG DOOR STOP

A concealed long door stop system gives ILLI sliding doors a controlled and gentle closing action. Double rollers with stainless steel ball bearings deliver an effortless sliding experience as the door glides along an innovative silent wheel track system.





IDEA  
CONCEPT  
PROTOTYPE  
ILI



ILI SLIDING DOOR WITH FRAMELESS SIDE PANEL - SILVER



# THE ILI<sup>®</sup> COLLECTION

BIFOLD  
DOOR

100

SLIDING  
DOOR

104

HINGE  
DOOR

108

ONE DOOR  
SLIDING  
QUADRANT &  
OFFSET  
QUADRANT

110

ONE DOOR  
HINGED  
QUADRANT &  
OFFSET  
QUADRANT

114

---

## SILVER 1800MM HEIGHT OPTIONS

BABY ILI  
COLLECTION  
1800MM

119

# BIFOLD DOOR

SILVER

MATTE BLACK

The space saving Ili Bifold door is perfect for use in smaller bathrooms or where space is restricted.

With flexibility in mind, the door opens inwards to create optimal access. The innovative magnetic bifold hinge creates seamless functionality as the door opens and closes. As is standard across the Ili collection, the bifold door comes with a reassuring lifetime guarantee for the ultimate peace of mind.

## DOOR SIZE OPTIONS

PRODUCT SIZE (mm)	ADJUSTMENT SIZE		ACCESS (mm)	CODE SILVER	CODE MATTE BLACK
	MIN (mm)	MAX (mm)			
700mm	650mm	700mm	472mm	ILIBF70SC	ILIBF70BC
760mm	710mm	760mm	472mm	ILIBF76SC	ILIBF76BC
800mm	750mm	800mm	512mm	ILIBF80SC	ILIBF80BC
850mm	800mm	850mm	521mm	ILIBF85SC	-
900mm	850mm	900mm	571mm	ILIBF90SC	ILIBF90BC
1000mm	950mm	1000mm	671mm	ILIBF100SC	ILIBF100BC

### BIFOLD - DOOR OPEN POSITION MEASUREMENTS

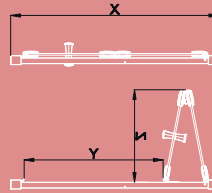

















BIFOLD DOOR SIZE	X SIZE	Y SIZE	Z SIZE
700mm	650-700	472mm	313mm
760mm	710-760mm	472mm	313mm
800mm	750-800mm	512mm	333mm
850mm	800-850mm	521mm	354mm
900mm	850-900mm	571mm	379mm
1000mm	950-1000mm	671mm	431mm

## SEMI FRAMED SIDE PANEL OPTIONS *(Includes Corner Profile)*

PRODUCT SIZE (mm)	ADJUSTMENT SIZE		CODE SILVER	CODE MATTE BLACK
	MIN (mm)	MAX (mm)		
700mm	665mm	690mm	ILISP70SC	ILISP70BC
760mm	725mm	750mm	ILISP76SC	ILISP76BC
800mm	765mm	790mm	ILISP80SC	ILISP80BC
900mm	865mm	890mm	ILISP90SC	ILISP90BC
1000mm	965mm	990mm	ILISP100SC	ILISP100BC

## COMPENSATING BAR

PRODUCT DESCRIPTION	CODE SILVER	CODE MATTE BLACK
25mm Compensating Wall Profile	ILICB25SC	ILICB25BC

 1950mm HEIGHT	 6mm TOUGHENED SAFETY GLASS	 25mm PROFILE ADJUSTMENT	 CLEARVUE GLASS COATING	 ANODISED ALUMINIUM PROFILES	 REVERSIBLE	 25MM WALL PROFILE EXTENSION AVAILABLE	 CHROME PLATED HANDLE
 ULTRA CLEAR PVC SEALS	 CHROME PLATED ABS COVER CAPS	 SEAMLESS INTERIOR COVER STRIPS	 PRE-ASSEMBLED DOOR FRAME ON BIFOLD AND HINGE DOOR	 SUITABLE FOR SHOWER TRAY OR WETROOM INSTALLATION	 SPACE SAVING SOLUTION	 MAGNETIC CLOSURE	 LIFETIME GUARANTEE



BIFOLD DOOR WITH SEMI FRAMED SIDE PANEL - SILVER



MAGNETIC BIFOLD HINGE

BIFOLD DOOR IN ALCOVE - MATTE BLACK

# BIFOLD DOOR

BRUSHED BRASS

The space saving Ili Bifold door is perfect for use in smaller bathrooms or where space is restricted.

With flexibility in mind, the door opens inwards to create optimal access. The innovative magnetic bifold hinge creates seamless functionality as the door opens and closes. As is standard across the Ili collection, the bifold door comes with a reassuring lifetime guarantee for the ultimate peace of mind.

## DOOR SIZE OPTIONS

PRODUCT DESCRIPTION	ADJUSTMENT SIZE		ACCESS	CODE BRUSHED BRASS
	MIN	MAX		
800mm	750mm	800mm	512mm	ILIBF80BRBC
900mm	850mm	900mm	571mm	ILIBF90BRBC
1000mm	950mm	1000mm	671mm	ILIBF100BRBC

## SEMI FRAMED SIDE PANEL OPTIONS *(Includes Corner Profile)*

PRODUCT DESCRIPTION	ADJUSTMENT SIZE		CODE BRUSHED BRASS
	MIN	MAX	
700mm	665mm	690mm	ILISP70BRBC
800mm	765mm	790mm	ILISP80BRBC
900mm	865mm	890mm	ILISP90BRBC

## COMPENSATING BAR

PRODUCT DESCRIPTION	COLOUR	CODE BRUSHED BRASS
Compensating Bar 25mm	Brushed Brass	ILICB25BRBC

### BIFOLD - DOOR OPEN POSITION MEASUREMENTS

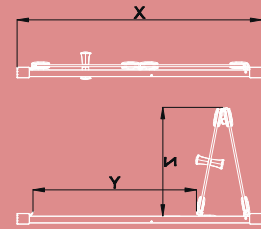

BIFOLD DOOR SIZE	X SIZE	Y SIZE	Z SIZE
800mm	750-800mm	512mm	333mm
900mm	850-900mm	571mm	379mm
1000mm	950-1000mm	671mm	431mm

1950mm HEIGHT	6mm TOUGHENED SAFETY GLASS	25mm PROFILE ADJUSTMENT	CLEARVUE GLASS COATING	ANODISED ALUMINIUM PROFILES	REVERSIBLE	25MM WALL PROFILE EXTENSION AVAILABLE	CHROME PLATED HANDLE
ULTRA CLEAR PVC SEALS	CHROME PLATED ABS COVER CAPS	SEAMLESS INTERIOR COVER STRIPS	PRE-ASSEMBLED DOOR FRAME ON BIFOLD AND HINGE DOOR	SUITABLE FOR SHOWER TRAY OR WETROOM INSTALLATION	SPACE SAVING SOLUTION	MAGNETIC CLOSURE	LIFETIME GUARANTEE



BIFOLD DOOR  
ALCOVE INSTALLATION

BIFOLD DOOR  
WITH SIDE PANEL

# SLIDING DOOR

SILVER

MATTE BLACK

The ILI Sliding Door features a unique silent wheel track system that delivers a gently controlled opening and closing action. The 6mm toughened safety glass is framed with ultra slim profiles to give the door a clean, contemporary aesthetic.

With 9 different sizes to choose from, including an ingenious 1250mm option, the ILI Sliding Door is ideal for a wide variety of applications.

## DOOR SIZE OPTIONS

PRODUCT SIZE (mm)	ADJUSTMENT SIZE		ACCESS (mm)	CODE	CODE
	MIN (mm)	MAX (mm)		SILVER	MATTE BLACK
1000mm	950mm	1000mm	370mm	ILISA100SC	ILISA100BC
1100mm	1050mm	1100mm	420mm	ILISA110SC	ILISA110BC
1200mm	1150mm	1200mm	470mm	ILISA120SC	ILISA120BC
1250mm	1200mm	1250mm	495mm	ILISA125SC	-
1300mm	1250mm	1300mm	520mm	ILISA130SC	-
1400mm	1350mm	1400mm	570mm	ILISA140SC	ILISA140BC
1500mm	1450mm	1500mm	570mm	ILISA150SC	ILISA150BC
1600mm	1550mm	1600mm	570mm	ILISA160SC	ILISA160BC
1700mm	1650mm	1700mm	570mm	ILISA170SC	ILISA170BC

## SEMI FRAMED SIDE PANEL OPTIONS *(Includes Corner Profile)*

PRODUCT SIZE (mm)	ADJUSTMENT SIZE		CODE	CODE
	MIN (mm)	MAX (mm)	SILVER	MATTE BLACK
700mm	665mm	690mm	ILISP70SC	ILISP70BC
760mm	725mm	750mm	ILISP76SC	ILISP76BC
800mm	765mm	790mm	ILISP80SC	ILISP80BC
900mm	865mm	890mm	ILISP90SC	ILISP90BC
1000mm	965mm	990mm	ILISP100SC	ILISP100BC

## NEW - FRAMELESS SIDE PANELS *(Suitable only for Sliding Door)*

PRODUCT SIZE (mm)	ADJUSTMENT SIZE		CODE	CODE
	MIN (mm)	MAX (mm)	SILVER	MATTE BLACK
700mm	665mm	690mm	ILIFSP70SC	ILIFSP70BC
760mm	725mm	750mm	ILIFSP76SC	ILIFSP76BC
800mm	765mm	790mm	ILIFSP80SC	ILIFSP80BC
900mm	865mm	890mm	ILIFSP90SC	ILIFSP90BC
1000mm	965mm	990mm	ILIFSP100SC	ILIFSP100BC

## COMPENSATING BAR

PRODUCT DESCRIPTION	CODE	CODE
	SILVER	MATTE BLACK
25mm Compensating Wall Profile	ILICB25SC	ILICB25BC



SLIDING DOOR WITH SEMI FRAMED SIDE PANEL - MATTE BLACK



















SLIDING DOOR IN ALCOVE - SILVER





SLIDING DOOR WITH  
FRAMELESS SIDE PANEL - SILVER

-  **1950mm**  
HEIGHT
-  **6mm**  
TOUGHENED  
SAFETY  
GLASS
-  **25mm**  
PROFILE  
ADJUSTMENT
-  **CHROME PLATED  
HANDLE**
-  **CLEARVUE  
GLASS COATING**
-  **ANODISED  
ALUMINIUM  
PROFILES**
-  **REVERSIBLE**
-  **SILENT WHEEL  
ROLLER  
MECHANISM**
-  **PRESS FIT  
SEAL DESIGN**
-  **ULTRA CLEAR  
PVC SEALS**
-  **CHROME  
PLATED ABS  
COVER CAPS**
-  **SEAMLESS  
INTERIOR  
COVER STRIPS**
-  **QUICK RELEASE  
DOUBLE WHEEL  
ROLLERS**
-  **SUITABLE FOR  
SHOWER TRAY  
OR WETROOM  
INSTALLATION**
-  **25MM WALL  
PROFILE  
EXTENSION  
AVAILABLE**
-  **LIFETIME  
GUARANTEE**
-  **CLICK FIT  
ASSEMBLY  
SYSTEM  
PATENTED**

# SLIDING DOOR

## BRUSHED BRASS

The ILI Sliding Door features a unique silent wheel track system that delivers a gently controlled opening and closing action. The 6mm toughened safety glass is framed with ultra slim profiles to give the door a clean, contemporary aesthetic.

With 6 different sizes to choose from, the ILI Sliding Door is ideal for a wide variety of applications.

### DOOR SIZE OPTIONS

PRODUCT DESCRIPTION	ADJUSTMENT SIZE		ACCESS	CODE BRUSHED BRASS
	MIN	MAX		
1000mm	950mm	1000mm	370mm	ILISA100BRBC
1100mm	1050mm	1100mm	420mm	ILISA110BRBC
1200mm	1150mm	1200mm	470mm	ILISA120BRBC
1400mm	1350mm	1400mm	570mm	ILISA140BRBC
1500mm	1450mm	1500mm	570mm	ILISA150BRBC
1700mm	1650mm	1700mm	570mm	ILISA170BRBC

### SEMI FRAMED SIDE PANEL OPTIONS *(Includes Corner Profile)*

PRODUCT DESCRIPTION	ADJUSTMENT SIZE		CODE BRUSHED BRASS
	MIN	MAX	
700mm	665mm	690mm	ILISP70BRBC
800mm	765mm	790mm	ILISP80BRBC
900mm	865mm	890mm	ILISP90BRBC

### COMPENSATING BAR

PRODUCT DESCRIPTION	COLOUR	CODE BRUSHED BRASS
Compensating Bar 25mm	Brushed Brass	ILICB25BRBC



 1950mm HEIGHT	 6mm TOUGHENED SAFETY GLASS	 25mm PROFILE ADJUSTMENT	 CHROME PLATED HANDLE	 CLEARVUE GLASS COATING	 ANODISED ALUMINIUM PROFILES	 REVERSIBLE	 SILENT WHEEL ROLLER MECHANISM	 PRESS FIT SEAL DESIGN
 ULTRA CLEAR PVC SEALS	 CHROME PLATED ABS COVER CAPS	 SEAMLESS INTERIOR COVER STRIPS	 QUICK RELEASE DOUBLE WHEEL ROLLERS	 SUITABLE FOR SHOWER TRAY OR WETROOM INSTALLATION	 25MM WALL PROFILE EXTENSION AVAILABLE	 LIFETIME GUARANTEE	 CLICK FIT ASSEMBLY SYSTEM PATENTED	

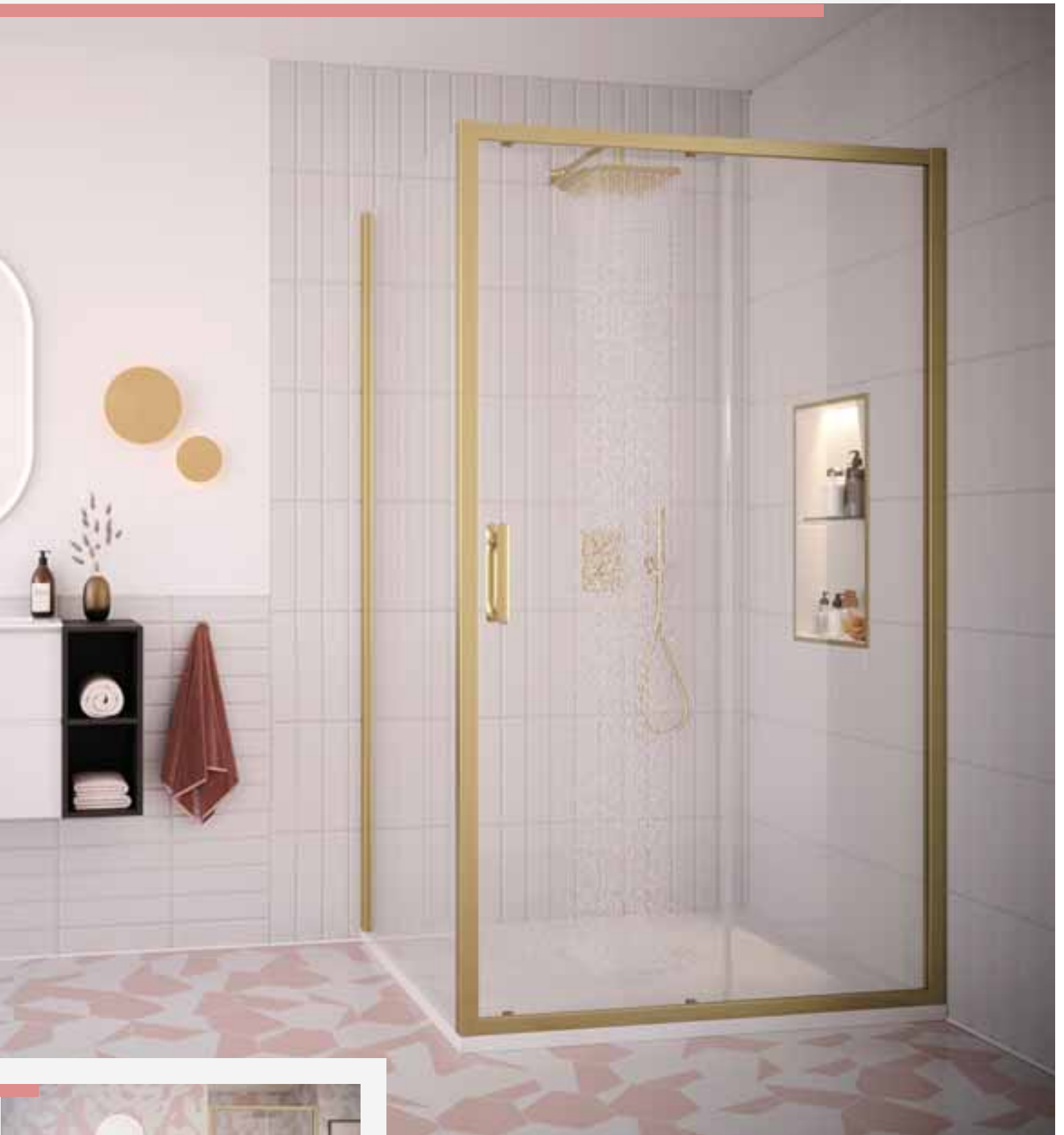

SLIDING DOOR  
WITH SIDE PANEL



SLIDING DOOR  
ALCOVE INSTALLATION



HINGE DOOR IN ALCOVE - SILVER



SOFTLY  
CURVED IJI  
HINGE  
DESIGN

HINGE DOOR WITH SEMI FRAMED  
SIDE PANEL - MATTE BLACK



# HINGE DOOR

SILVER MATTE BLACK

The Ili hinge door is ideally suited where space is more limited in the bathroom. This outward opening hinge door has a firm magnetic close action. The ultra clear bottom door seal ensures optimal water retention.

The gently curved hinges are fully concealed on the inside, delivering visual perfection on both the exterior and interior of the shower.

## DOOR SIZE OPTIONS













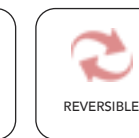

PRODUCT SIZE (mm)	ADJUSTMENT SIZE		ACCESS (mm)	CODE	CODE
	MIN (mm)	MAX (mm)		SILVER	MATTE BLACK
760mm	710mm	760mm	600mm	ILIH76SC	ILIH76BC
800mm	750mm	800mm	640mm	ILIH80SC	ILIH80BC
850mm	800mm	850mm	690mm	ILIH85SC	ILIH85BC
900mm	850mm	900mm	740mm	ILIH90SC	ILIH90BC
1000mm	950mm	1000mm	840mm	ILIH100SC	-

## SEMI FRAMED SIDE PANEL OPTIONS *(Includes Corner Profile)*

PRODUCT SIZE (mm)	ADJUSTMENT SIZE		CODE	CODE
	MIN (mm)	MAX (mm)		
700mm	665mm	690mm	ILISP70SC	ILISP70BC
760mm	725mm	750mm	ILISP76SC	ILISP76BC
800mm	765mm	790mm	ILISP80SC	ILISP80BC
900mm	865mm	890mm	ILISP90SC	ILISP90BC
1000mm	965mm	990mm	ILISP100SC	ILISP100BC

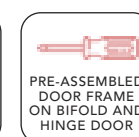
## COMPENSATING BAR

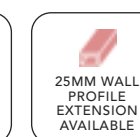
PRODUCT DESCRIPTION	CODE	CODE
	SILVER	MATTE BLACK
25mm Compensating Wall Profile	ILICB25SC	ILICB25BC

 1950mm HEIGHT	 6mm TOUGHENED SAFETY GLASS	 25mm PROFILE ADJUSTMENT	 CHROME PLATED HANDLE	 CLEARVUE GLASS COATING	 ANODISED ALUMINIUM PROFILES	 REVERSIBLE
 ULTRA CLEAR PVC SEALS	 CHROME PLATED ABS COVER CAPS	 SEAMLESS INTERIOR COVER STRIPS	 PRE-ASSEMBLED DOOR FRAME ON BIFOLD AND HINGE DOOR	 SUITABLE FOR SHOWER TRAY OR WETROOM INSTALLATION	 25MM WALL PROFILE EXTENSION AVAILABLE	 LIFETIME GUARANTEE

# ONE DOOR SLIDING QUADRANT & OFFSET QUADRANT

SILVER

MATTE BLACK

The Ili One Door Quadrant and Offset Quadrant are perfectly shaped to make the most out of a corner showering space.













This door has an incredibly smooth opening and closing action thanks to the silent wheel roller mechanism. The stainless steel rollers also boast a quick release design for hassle free cleaning. Clearvue hydrophobic coating resists the build up of grime and limescale on the glass.

## DOOR SIZE OPTIONS

PRODUCT SIZE (mm)	ADJUSTMENT SIZE		ACCESS (mm)	CODE	CODE
	MIN (mm)	MAX (mm)		SILVER	MATTE BLACK
900mm	870-895mm	870-895mm	485mm	ILICOQ90SC	ILICOQ90BC
800 x 1000mm	770-795mm	970-995mm	436mm	ILICOQ80X100SC	ILICOQ80X100BC
800 x 1200mm	770-795mm	1170-1195mm	436mm	ILICOQ80X120SC	ILICOQ80X120BC
900 x 1200mm	870-895mm	1170-1195mm	485mm	ILICOQ90X120SC	ILICOQ90X120BC



CRAFTED ILI HANDLE WITH INTEGRATED ROBE HOOK FEATURE

 <b>1950mm</b> HEIGHT	 <b>6mm</b> TOUGHENED SAFETY GLASS	 <b>25mm</b> PROFILE ADJUSTMENT	 CHROME PLATED HANDLE	 CLEARVUE GLASS COATING	 ANODISED ALUMINIUM PROFILES	 REVERSIBLE	 SILENT WHEEL ROLLER MECHANISM
 ULTRA CLEAR PVC SEALS	 CHROME PLATED ABS COVER CAPS	 SEAMLESS INTERIOR COVER STRIPS	 QUICK RELEASE DOUBLE WHEEL ROLLERS	 SUITABLE FOR SHOWER TRAY OR WETROOM INSTALLATION	 25MM WALL PROFILE EXTENSION AVAILABLE	 LIFETIME GUARANTEE	 <b>CLICK FIT ASSEMBLY SYSTEM</b> PATENTED



ONE DOOR OFFSET  
SLIDING QUADRANT -  
MATTE BLACK



ONE DOOR  
SLIDING  
QUADRANT -  
SILVER

# ONE DOOR SLIDING QUADRANT & OFFSET QUADRANT

BRUSHED BRASS

The Ili One Door Quadrant and Offset Quadrant are perfectly shaped to make the most out of a corner showering space.

This door has an incredibly smooth opening and closing action thanks to the silent wheel roller mechanism. The stainless steel rollers also boast a quick release design for hassle free cleaning. Clearvue hydrophobic coating resists the build up of grime and limescale on the glass.



## DOOR SIZE OPTIONS

PRODUCT DESCRIPTION	ADJUSTMENT SIZE		ACCESS	CODE
	MIN	MAX		BRUSHED BRASS
900mm	870-895mm	870-895mm	485mm	ILICOQ90BRBC
800 x 1200mm	770-795mm	1170-1195mm	436mm	ILICOQ80X120BRBC
900 x 1200mm	870-895mm	1170-1195mm	485mm	ILICOQ90X120BRBC



CRAFTED ILI HANDLE WITH INTEGRATED ROBE HOOK FEATURE

1950mm HEIGHT	6mm TOUGHENED SAFETY GLASS	25mm PROFILE ADJUSTMENT	CHROME PLATED HANDLE	CLEARVUE GLASS COATING	ANODISED ALUMINIUM PROFILES	REVERSIBLE	SILENT WHEEL ROLLER MECHANISM
ULTRA CLEAR PVC SEALS	CHROME PLATED ABS COVER CAPS	SEAMLESS INTERIOR COVER STRIPS	QUICK RELEASE DOUBLE WHEEL ROLLERS	SUITABLE FOR SHOWER TRAY OR WETROOM INSTALLATION	25MM WALL PROFILE EXTENSION AVAILABLE	LIFETIME GUARANTEE	<b>CLICK FIT ASSEMBLY SYSTEM</b> PATENTED





ONE DOOR  
SLIDING QUADRANT



ONE DOOR  
OFFSET  
SLIDING  
QUADRANT



HINGED OFFSET  
QUADRANT - SILVER

OFFSET QUADRANT  
DOOR MUST  
HINGE FROM  
THE LONG SIDE



HINGED QUADRANT -  
MATTE BLACK

# HINGED QUADRANT & HINGED OFFSET QUADRANT

SILVER

MATTE BLACK

One of a kind, the Hinged Quadrant and Hinged Offset Quadrant is a unique option for corner shower spaces.

Vertical magnetic seals ensure water tightness and give the door a reassuring positive close action. All internal fixation points are concealed with cover strips ensuring the interior of this shower door is visually perfect. Cleaning is made easy with Clearvue hydrophobic coating on the 6mm toughened safety glass.

## DOOR SIZE OPTIONS





PRODUCT SIZE (mm)	ADJUSTMENT SIZE		ACCESS (mm)	CODE	CODE
	MIN (mm)	MAX (mm)		SILVER	MATTE BLACK
900mm	870-895mm	870-895mm	585mm	ILIHQ90SC	ILIHQ90BC
800 x 1200mm	770-795mm	1170-1195mm	585mm	ILIHQ80X120SC	ILIHQ80X120BC
900 x 1200mm	870-895mm	1170-1195mm	585mm	ILIHQ90X120SC	ILIHQ90X120BC



EXTERIOR VIEW OF HINGE



CRAFTED ILI HANDLE WITH INTEGRATED ROBE HOOK FEATURE

 <b>1950mm</b> HEIGHT	 <b>6mm</b> TOUGHENED SAFETY GLASS	 <b>25mm</b> PROFILE ADJUSTMENT	 CHROME PLATED HANDLE	 CLEARVUE GLASS COATING	 ANODISED ALUMINIUM PROFILES	 REVERSIBLE	 25MM WALL PROFILE EXTENSION AVAILABLE
 ULTRA CLEAR PVC SEALS	 CHROME PLATED ABS COVER CAPS	 SEAMLESS INTERIOR COVER STRIPS	 SUITABLE FOR SHOWER TRAY OR WETROOM INSTALLATION	 LIFETIME GUARANTEE	 <b>CLICK FIT ASSEMBLY SYSTEM</b> PATENTED		



HINGED OFFSET  
QUADRANT -  
OFFSET QUADRANT  
DOOR MUST  
HINGE FROM  
THE LONG SIDE



# HINGED QUADRANT & HINGED OFFSET QUADRANT

BRUSHED BRASS

One of a kind, the Hinged Quadrant and Hinged Offset Quadrant is a unique option for corner shower spaces.

Vertical magnetic seals ensure water tightness and give the door a reassuring positive close action. All internal fixation points are concealed with cover strips ensuring the interior of this shower door is visually perfect. Cleaning is made easy with Clearvue hydrophobic coating on the 6mm toughened safety glass.

## DOOR SIZE OPTIONS

PRODUCT DESCRIPTION	ADJUSTMENT SIZE MIN	MAX	ACCESS	CODE BRUSHED BRASS
900mm	870-895mm	870-895mm	585mm	ILHQ90BRBC
800 x 1200mm	770-795mm	1170-1195mm	585mm	ILHQ80X120BRBC
900 x 1200mm	870-895mm	1170-1195mm	585mm	ILHQ90X120BRBC



EXTERIOR VIEW OF HINGE



CRAFTED ILI HANDLE WITH INTEGRATED ROBE HOOK FEATURE

 <b>1950mm</b> HEIGHT	 <b>6mm</b> TOUGHENED SAFETY GLASS	 <b>25mm</b> PROFILE ADJUSTMENT	 CHROME PLATED HANDLE	 CLEARVUE GLASS COATING	 ANODISED ALUMINIUM PROFILES	 REVERSIBLE	 25MM WALL PROFILE EXTENSION AVAILABLE
 ULTRA CLEAR PVC SEALS	 CHROME PLATED ABS COVER CAPS	 SEAMLESS INTERIOR COVER STRIPS	 SUITABLE FOR SHOWER TRAY OR WETROOM INSTALLATION	 LIFETIME GUARANTEE	 <b>CLICK FIT ASSEMBLY SYSTEM</b> PATENTED		





# THE BABY ILI<sup>®</sup> COLLECTION

SLIDING DOOR  
IN ALCOVE

1800MM HEIGHT

Born out of the ingenuity of the ILI collection, BABY ILI is a reduced height offering that is the perfect fit where ceiling height is restricted.

At 1800mm high, Baby ILI fits seamlessly under low ceilings. An ideal solution for attic conversions, low and sloped ceilings, BABY ILI is available in a variety of different door types that not only maximise space but enhance the aesthetics of your bathroom.

# BABY ILI<sup>®</sup> FUNCTIONAL DETAILS



1800MM HIGH  
SHOWER DOORS



VISUALLY ATTRACTIVE  
ULTRA CLEAR PVC DOOR SEALS



6MM TOUGHENED  
SAFETY GLASS THICKNESS,  
CERTIFIED TO EN12150



SEAMLESS INTERIOR  
COVER STRIPS CONCEAL ALL  
FIXATION POINTS INTERNALLY



25MM ADJUSTMENT ON  
EACH WALL PROFILE



INNOVATIVE PRESS FIT SEAL DESIGN  
FOR EASE OF INSTALLATION



PRECISELY CRAFTED SOLID CHROME  
PLATED ILI HANDLES THAT FEATURE  
AN INTEGRATED ROBE HOOK DESIGN



PRE ASSEMBLED DOOR FRAME  
ON BIFOLD & HINGE DOOR -  
FOR EASE OF INSTALLATION



CLEARVUE IS A HYDROPHOBIC  
GLASS COATING THAT RESISTS  
THE BUILD UP OF LIMESCALE AND  
GRIME ON THE GLASS SURFACE



SUITABLE FOR INSTALLATION  
WITH SIDE PANELS



SILENT WHEEL  
ROLLER MECHANISM



ULTRA SLIM COVER CAP  
DESIGN FOR A SLEEK AND  
MODERN DOOR AESTHETIC



SUPERIOR QUICK RELEASE  
DOUBLE WHEEL ROLLERS WITH  
STAINLESS STEEL BEARINGS



LIFETIME  
GUARANTEE



ALL ILI DOOR STYLES ARE  
FULLY REVERSIBLE FOR LEFT OR  
RIGHT HAND INSTALLATION



SUITABLE FOR  
WETROOM AND  
SHOWER TRAY  
INSTALLATION





CRAFTED ILI HANDLE WITH INTEGRATED ROBE HOOK FEATURE



ILI DOUBLE WHEEL ROLLER WITH SILENT WHEEL ROLLER TRACK



ILI CURVED DOUBLE HINGE



SLIDING DOOR IN ALCOVE

# BABY ILI

1800MM HEIGHT ON ALL BABY ILI SHOWER DOORS

Tailored for bathrooms with limited vertical space, Baby Ili is just 1800mm meters high and boasts a compact design that fits snugly under low ceilings, ensuring both comfort and practicality.

An Ideal solution for loft conversions, low and sloped ceilings, our 1800mm high shower enclosures come available in a variety of different door types that not only maximize space but also enhance the aesthetics of your bathroom, creating a haven of relaxation and functionality. You won't have to compromise on comfort or style.

## BIFOLD DOOR – SIZE OPTIONS

PRODUCT SIZE	ADJUSTMENT SIZE		ACCESS	CODE - SILVER
	MIN	MAX		
700mm	650mm	700mm	472mm	ILI180BF70SC
800mm	750mm	800mm	512mm	ILI180BF80SC
900mm	850mm	900mm	571mm	ILI180BF90SC
1000mm	950mm	1000mm	671mm	ILI180BF100SC

## ONE DOOR SLIDING QUADRANT – SIZE OPTIONS

PRODUCT SIZE	ADJUSTMENT SIZE		ACCESS	CODE - SILVER
	MIN	MAX		
800mm	770mm	795mm	436mm	ILI180COQ80SC
900mm	870mm	895mm	485mm	ILI180COQ90SC

## SEMI FRAMED SIDE PANEL – SIZE OPTIONS *(Includes Corner Profile)*

PRODUCT SIZE	ADJUSTMENT SIZE		CODE - SILVER
	MIN	MAX	
700mm	665mm	690mm	ILI180SP70SC
800mm	765mm	790mm	ILI180SP80SC
900mm	865mm	890mm	ILI180SP90SC
1000mm	965mm	990mm	ILI180SP100SC



ONE DOOR SLIDING QUADRANT



BIFOLD DOOR WITH SEMI FRAMED SIDE PANEL



**1800mm**  
HEIGHT

**6mm**  
TOUGHENED  
SAFETY  
GLASS

**25mm**  
PROFILE  
ADJUSTMENT

**CHROME PLATED  
HANDLE**

**CLEARVUE  
GLASS COATING**

**ULTRA CLEAR  
PVC SEALS**

**CHROME  
PLATED ABS  
COVER CAPS**

**SEAMLESS  
INTERIOR  
COVER STRIPS**

**PRE-ASSEMBLED  
DOOR FRAME  
ON BIFOLD AND  
HINGE DOOR**

**SUITABLE FOR  
SHOWER TRAY  
OR WETROOM  
INSTALLATION**

**ANODISED  
ALUMINIUM  
PROFILES**

**REVERSIBLE**

**LIFETIME  
GUARANTEE**

**BIFOLD - DOOR OPEN  
POSITION MEASUREMENTS**

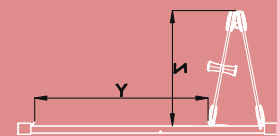

BIFOLD DOOR SIZE	X SIZE	Y SIZE	Z SIZE
700mm	650-700mm	412mm	283mm
800mm	750-800mm	512mm	333mm
900mm	850-900mm	571mm	379mm
1000mm	950-1000mm	671mm	431mm

# BABY ILI

1800MM HEIGHT ON ALL BABY ILI SHOWER DOORS

## HINGE DOOR – SIZE OPTIONS

PRODUCT SIZE	ADJUSTMENT SIZE		ACCESS	CODE - SILVER
	MIN	MAX		
700mm	650mm	700mm	640mm	ILI180HD70SC
760mm	710mm	760mm	640mm	ILI180HD76SC
800mm	750mm	800mm	640mm	ILI180HD80SC
900mm	850mm	900mm	740mm	ILI180HD90SC

## SLIDING DOOR – SIZE OPTIONS

PRODUCT SIZE	ADJUSTMENT SIZE		ACCESS	CODE - SILVER
	MIN	MAX		
1000mm	950mm	1000mm	470mm	ILI180SA100SC
1200mm	1150mm	1200mm	470mm	ILI180SA120SC
1400mm	1350mm	1400mm	470mm	ILI180SA140SC

## SEMI FRAMED SIDE PANEL – SIZE OPTIONS *(Includes Corner Profile)*

PRODUCT SIZE	ADJUSTMENT SIZE		CODE - SILVER
	MIN	MAX	
700mm	665mm	690mm	ILI180SP70SC
800mm	765mm	790mm	ILI180SP80SC
900mm	865mm	890mm	ILI180SP90SC
1000mm	965mm	990mm	ILI180SP100SC



HINGE DOOR WITH SEMI FRAMED SIDE PANEL

CRAFTED ILI HANDLE WITH INTEGRATED ROBE HOOK FEATURE



 <b>1800mm</b> HEIGHT	 <b>6mm</b> TOUGHENED SAFETY GLASS	 <b>25mm</b> PROFILE ADJUSTMENT	 CHROME PLATED HANDLE	 CLEARVUE GLASS COATING	 ANODISED ALUMINIUM PROFILES	 REVERSIBLE
 ULTRA CLEAR PVC SEALS	 CHROME PLATED ABS COVER CAPS	 SEAMLESS INTERIOR COVER STRIPS	 PRE-ASSEMBLED DOOR FRAME ON BIFOLD AND HINGE DOOR	 SUITABLE FOR SHOWER TRAY OR WETROOM INSTALLATION	 LIFETIME GUARANTEE	





SLIDING DOOR WITH SEMI  
FRAMED SIDE PANEL



## DESIGN AWARD

Flair are proud to have received the **Good Design** Award accolade in recognition of the AYO wetroom collection.

The **Good Design** Award is a seal of global design excellence and a testimony to our passion for product quality and innovation.

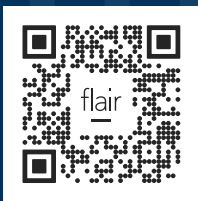

EXPLORE  
AYO

AYO

MODULAR WETROOM  
COLLECTION 8mm & 10mm

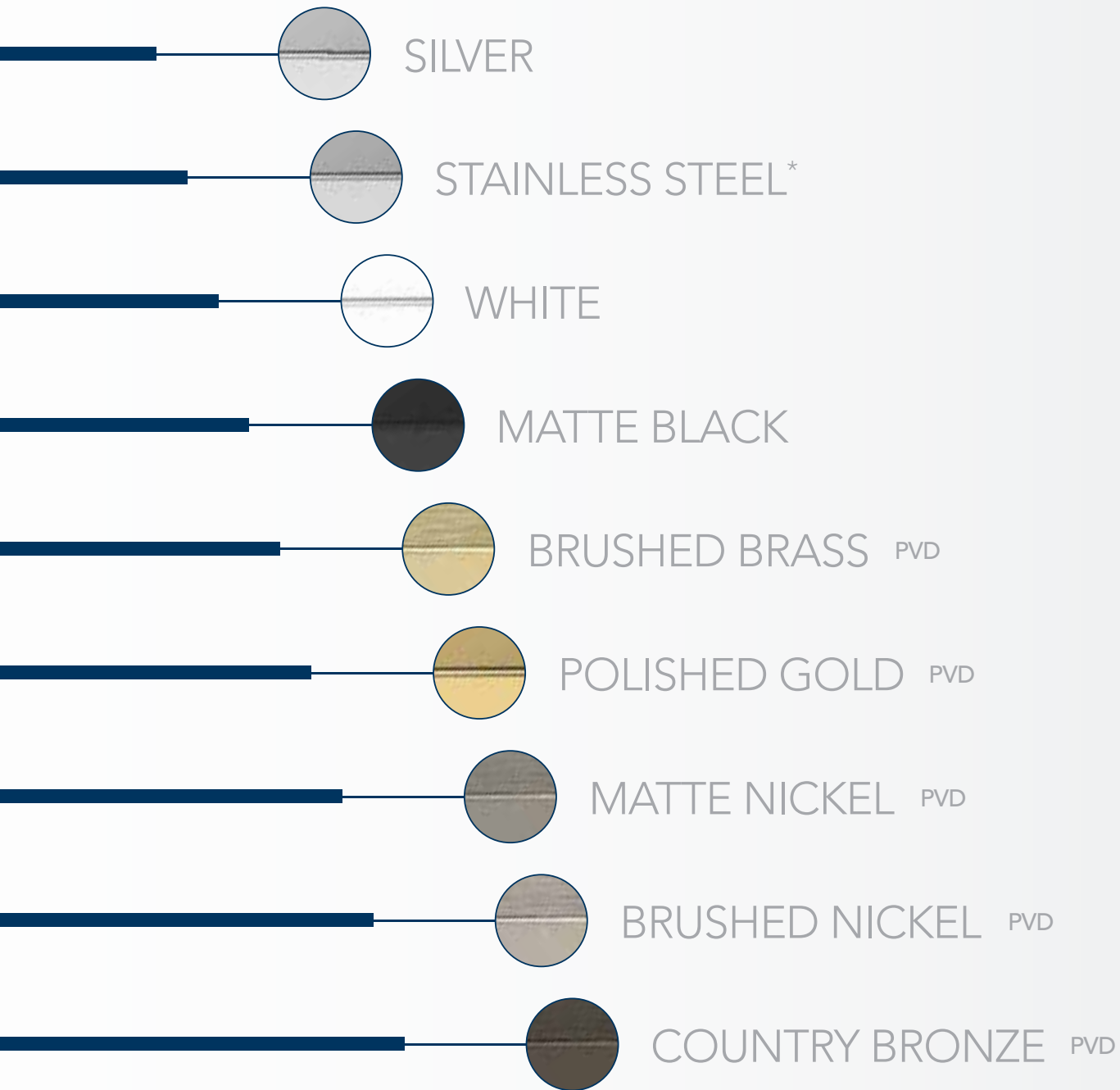

## FINISHES

S - Silver  
SS - Stainless Steel  
W - White  
B - Matte Black  
BRB - Brushed Brass

PG - Polished Gold  
BRMN - Matte Nickel  
BRN - Brushed Nickel  
CTRY BRZ - Country Bronze

## PVD

The PVD coating is applied to high grade 304 stainless steel base material. The result is a superbly robust and hard wearing finish.

\* Polished Stainless Steel is high grade 304 stainless steel.



# THE AYO<sup>®</sup> COLLECTION

**The AYO modular wetroom collection is crafted to create a truly personal shower experience.**

Standing tall at a height of 2 metres, AYO comes in 8mm and 10mm glass which is treated with a hydrophobic coating that resists the build up of grime and lime scale.

With an abundance of configurations and fixture innovations such as recessed channels, fixed and rotating deflector panels, ultra-clear seals and stylish stabilising bar options, makes this a truly versatile modular wetroom system. AYO boasts 3 glass options - clear, fluted and opaque.

Now available in 9 high quality colour finishes, AYO will pair perfectly with other signature elements in any bathroom.



---

HARMONY  
CREATED FROM  
EVERY ANGLE







# THE AYO<sup>®</sup> WETROOM COLLECTION

---

INTRODUCING  
AYO COLOUR

134

---

WETROOM  
DEFLECTOR PANEL  
FIXED & ROTATING

136

---

HINGED ROTATING  
DEFLECTOR  
PANELS

140

---

AYO  
FRAMED

160

---

AYO  
COMPLETE KITS  
8MM & 10MM

145

---

BATHSCREENS

170

---

AYO  
MODULAR  
8MM & 10MM

177

# AYO<sup>®</sup> COLOUR

## THE PVD PROCESS EXPLAINED

### PVD - PHYSICAL VAPOUR DEPOSITION

PVD is a technique that applies colour on an atomic level to a base surface inside a vacuum chamber. This process physically changes the original base material to the desired colour composition, meaning that the surface won't wear off or degenerate over time.

PVD is one of the most durable colouring technologies being up to 3 times harder and 10 times more scratch resistant than the alternative surface options.

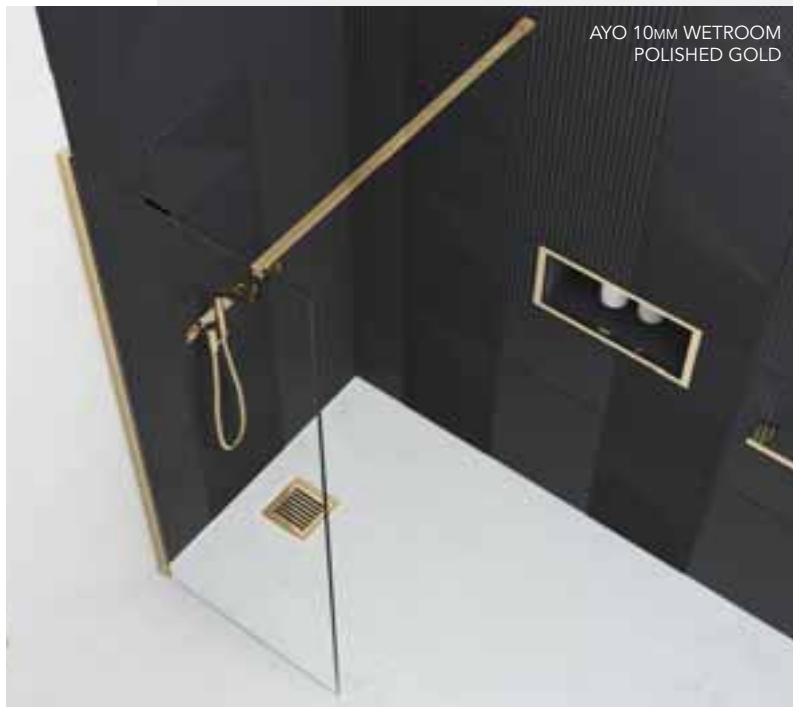



## INFLUENCED BY SIMPLE AESTHETICS

The PVD Finish extends across a select offering of AYO components that includes a 15mm Wall Profile, 1200mm Straight Stabilising Bar, 650mm Angled Stabilising Bar and T Piece.

AYO 10mm WETROOM BRUSHED BRASS

CONFIGURATION 11 IN BLACK



AYO WHITE WETROOM & ROTATING RETURN PANEL



FIXED DEFLECTOR PANEL - CONFIGURATION 12  
POSSIBLE IN ALL FINISHES





# WETROOM DEFLECTOR PANEL

## FIXED & ROTATING

Combining effortlessly with AYO wetroom panels, our range of fixed and rotating deflector panels offers comprehensive splash protection whilst maintaining an elegant, tranquil aesthetic within your bathroom.

Showcasing spacious access to the shower area, the rotating deflector design can be folded to an impressive 180 degrees.\*

Enhance your wetroom design by choosing a minimal ultra clear corner joining seal - maximising your showers visual appeal.

A range of deflector panel sizes are available alongside a selection of stabilising bar configurations to suit your individual needs. Rotating panels can also be retrofitted.

### CHOOSE YOUR CONFIGURATION

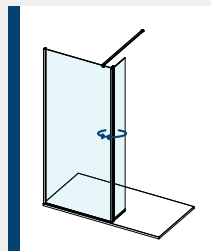

**CONFIGURATION 11**

- x1 Glass Panel
- x1 Wall Profile
- x1 Straight Stabilising Bar
- x1 Rotating Panel

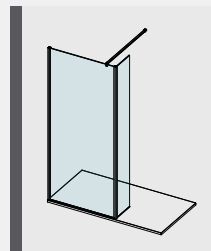

**CONFIGURATION 12**

- x2 Glass Panel
- x1 Wall Profile
- x1 Ultra Clear Corner Seal
- x1 Glass Joining Bracket
- x1 Straight Stabilising Bar

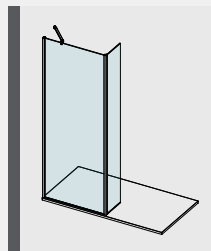

**CONFIGURATION 13**

- x2 Glass Panels
- x1 Wall Profile
- x1 Ultra Clear Corner Seal
- x1 Angled Stabilising bar

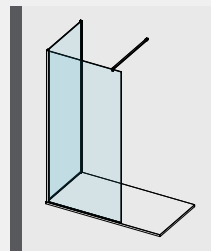

**CONFIGURATION 14**

- x2 Glass Panels
- x1 Wall Profile
- x1 Ultra Clear Corner Seal
- x1 Straight Stabilising Bar



AVAILABLE IN SILVER, MATTE BLACK AND WHITE

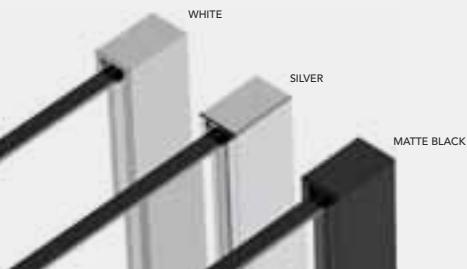

**\*Please Note:**  
Rotating Deflector Panels available in Silver and Black only.

# HINGED ROTATING DEFLECTOR PANEL



HINGE & ROTATING PANELS - BRUSHED BRASS

The AYO Hinge Rotating Deflector Panel offers both visual appeal and practical functionality.

Designed to fit alongside an AYO wetroom panel, these minimalist glass rotating panels can be folded to an impressive 180 degrees. This allows for generous access to the shower; whilst protecting the bathroom from unwanted water splash.

Available in a variety of premium colour finishes, there is an option to suit all bathroom needs. The frameless design of the hinge rotating panel delivers an effortless luxury to the wetroom shower zone.

<p><b>8mm</b> TOUGHENED SAFETY GLASS</p>	<p><b>2000mm</b> HEIGHT</p>	<p><b>REVERSIBLE</b></p>	<p><b>WETROOM OR SHOWER TRAY INSTALLATION</b></p>
--	---------------------------------	--------------------------	---

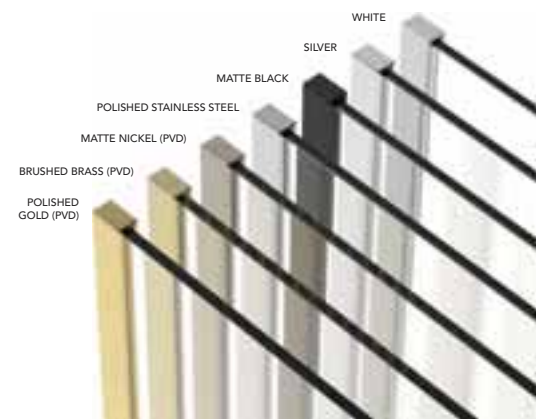





CONFIGURATION 21 IN WHITE



CONFIGURATION 20 IN BLACK

# CORNER WALK-IN WETROOM

Offering form as well as function, the AYO Walk-In configuration showcases an enclosed design to ensure minimal splash.

Elegant stainless-steel support bars create a simple, yet beautiful aesthetic. The AYO Corner walk in arrangement is designed to deliver maximum sophistication and enhance the art of showering.

With ClearVue hydrophobic coating resisting the build-up of grime and limescale on glass surfaces, AYO wetrooms truly lend themselves to easy maintenance.

## CHOOSE YOUR CONFIGURATION

8+10mm  
TOUGHENED SAFETY GLASS

FOR A CORNER SPACE

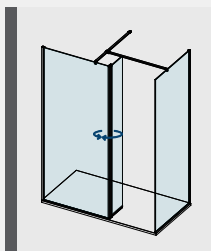

**CONFIGURATION 19**

- x2 Glass Panels
- x1 Rotating Panel
- x2 Wall Profiles
- x2 Straight Stabilising Bars
- x1 T Piece

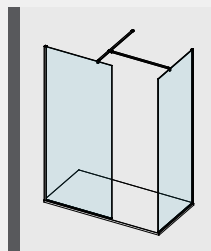

**CONFIGURATION 20**

- x2 Glass Panels
- x2 Straight Stabilising Bars
- x2 Wall Profiles
- x1 T Piece

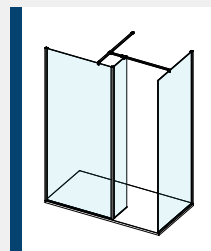

**CONFIGURATION 21**

- x3 Glass Panels
- x2 Wall Profiles
- x1 Ultra Clear Corner Seal
- x1 Glass Joining Bracket
- x2 Straight Stabilising Bars
- x1 T Piece



**CONFIGURATION 20 IN POLISHED STAINLESS STEEL**

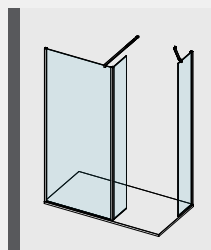
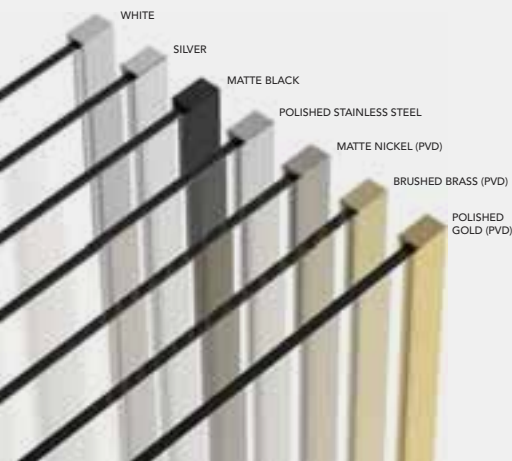

**CONFIGURATION 22**

- x3 Glass Panels
- x2 Wall Profiles
- x1 Ultra Clear Corner Seal
- x1 Straight Stabilising Bar
- x1 Angled Stabilising Bar

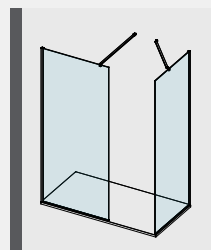

**CONFIGURATION 23**

- x2 Glass Panels
- x2 Wall Profiles
- x1 Straight Stabilising Bar
- x1 Angled Stabilising Bar

**Please Note:** Colour PVD Finishes only available on 1200mm straight or 650mm angled stabilising bars.

---

# CONFIGURATION GUIDE

With an almost infinite choice of wetroom configurations, AYO provides maximum flexibility as you personalise your dream shower space.

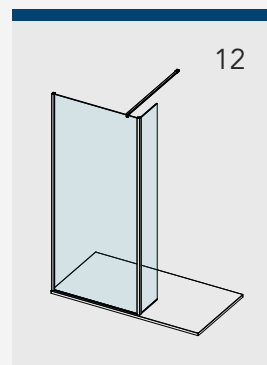
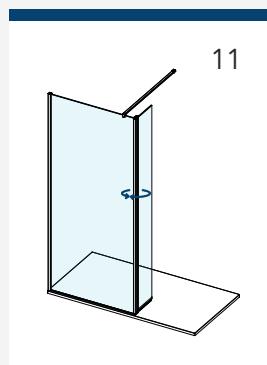
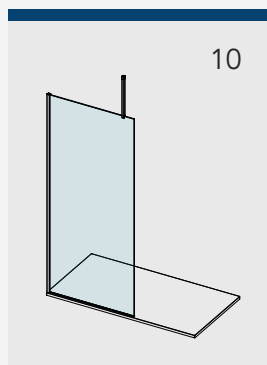
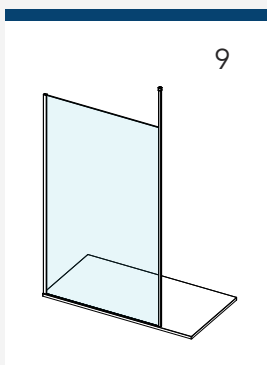
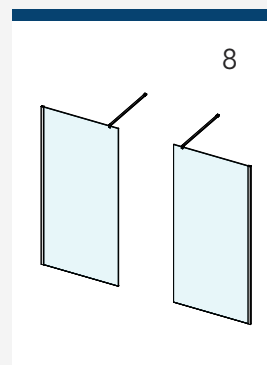
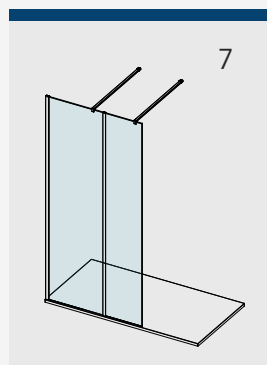
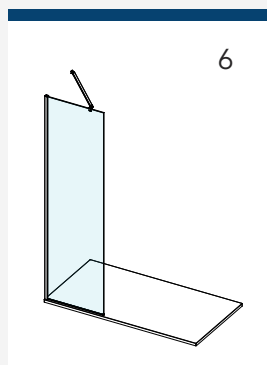
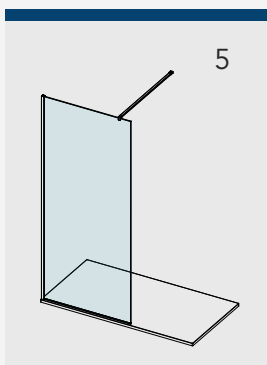
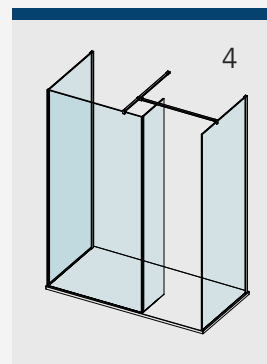
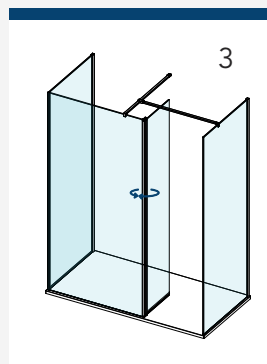
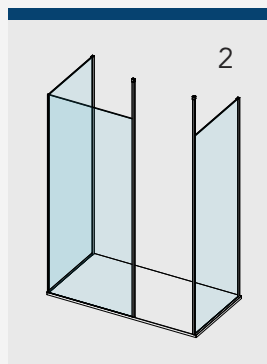
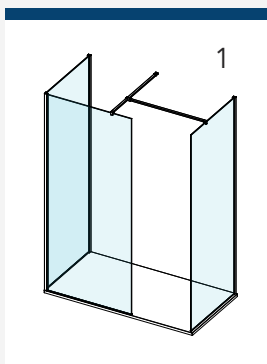

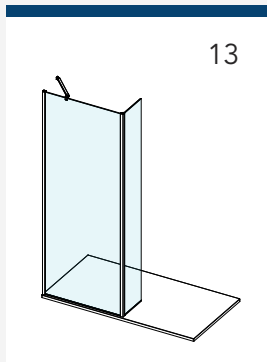

13

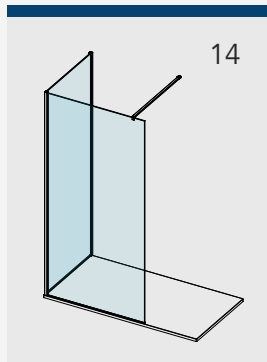

14

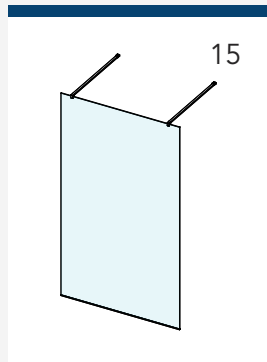

15

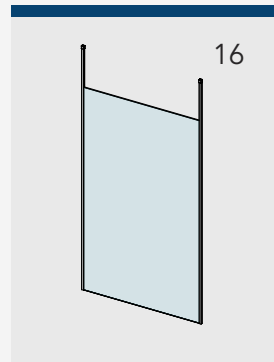

16

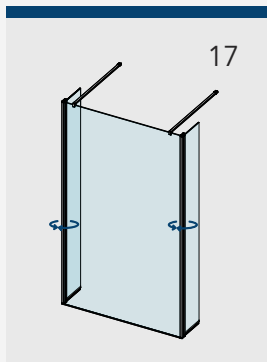

17

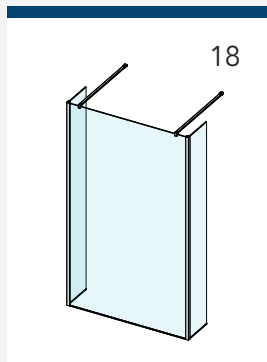

18

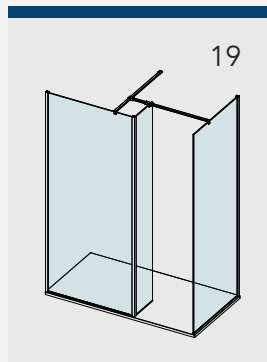

19

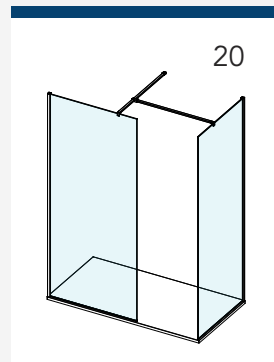

20

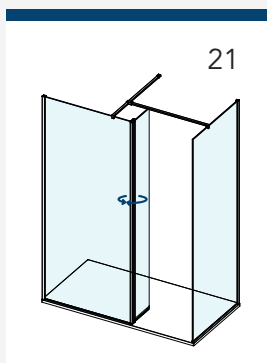

21

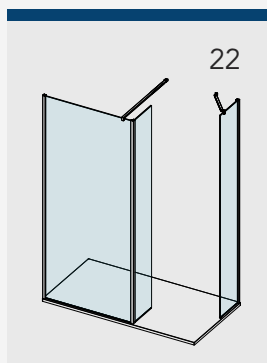

22

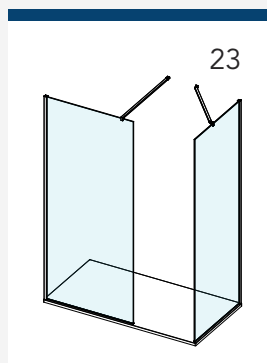

23

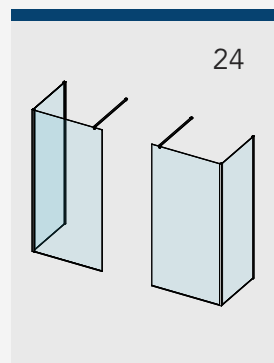

24

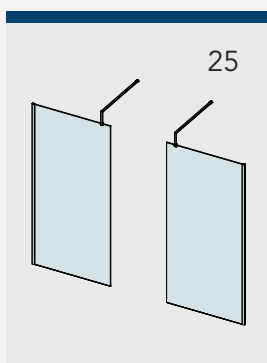

25

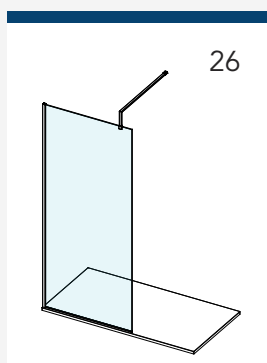

26

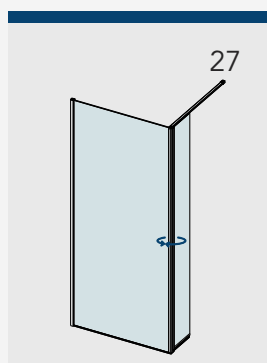

27

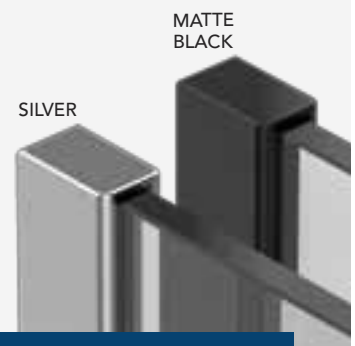

---

# AYO<sup>®</sup>

## COMPLETE WETROOM KITS

For ease of ordering, we have created complete wetroom kits for the most popular wetroom configuration choices.

Each complete kit below includes a glass panel, a 15mm wall profile and a suitable stabilising bar solution.



AYO WETROOM CONFIGURATION 5 – MATTE BLACK





# AYO® 10MM COMPLETE WETROOM KITS CLEAR GLASS – SILVER & BLACK

For ease of ordering, we have created product codes for complete wetroom kits that cover the most popular wetroom configuration choices.

Each complete kit below includes a 10mm clear glass panel, a 15mm wall profile and a suitable stabilising bar solution.

**For 10mm Modular Wetroom Order Process, please go to page 186.**

## 10MM COMPLETE WETROOM KITS

SIZE	CODE – SILVER	CODE – BLACK
300mm	AYO10MWR30SC	AYO10MWR30BC
400mm	AYO10MWR40SC	AYO10MWR40BC
450mm	AYO10MWR45SC	AYO10MWR45BC
500mm	AYO10MWR50SC	AYO10MWR50BC
600mm	AYO10MWR60SC	AYO10MWR60BC
700mm	AYO10MWR70SC	AYO10MWR70BC
760mm	AYO10MWR76SC	AYO10MWR76BC
800mm	AYO10MWR80SC	AYO10MWR80BC
900mm	AYO10MWR90SC	AYO10MWR90BC
1000mm	AYO10MWR100SC	AYO10MWR100BC
1100mm	AYO10MWR110SC	AYO10MWR110BC
1200mm	AYO10MWR120SC	AYO10MWR120BC
1400mm	AYO10MWR140SC	AYO10MWR140BC
<b>Double Entry Wetroom 1200mm – Complete Package (Includes 2 1200mm Straight Stabilising Bars)</b> AYO10MWRD120SC    AYO10MWRD120BC		

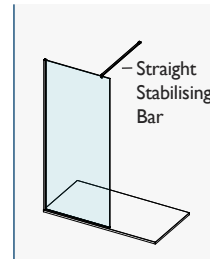
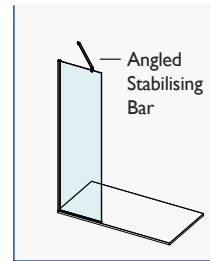

350mm Angled Stabilising Bar included with 300 & 400mm COMPLETE wetroom kits.  
 650mm Angled Stabilising Bar included with 450, 500 & 600mm COMPLETE wetroom kits.  
 1200mm Straight Stabilising Bar included with COMPLETE wetroom kits over 700mm.

## 10MM COMPLETE WETROOM SIDE PANEL KITS\*

SIZE	CODE – SILVER	CODE – BLACK
700mm	AYO10MWR70TSC	AYO10MWR70TBC
760mm	AYO10MWR76TSC	AYO10MWR76TBC
800mm	AYO10MWR80TSC	AYO10MWR80TBC
900mm	AYO10MWR90TSC	AYO10MWR90TBC
1000mm	AYO10MWR100TSC	AYO10MWR100TBC



\*1200mm Straight Stabilising Bar and T Piece included with COMPLETE Wetroom Side Panel Kits

NOTE: 2 PACK DELIVERY

Pack 1 – Glass Panel

Pack 2 – Wall Profile & Stabiliser

10MM COMPLETE

## ACCESSORIES

SIZE	CODE - SILVER	CODE - BLACK
T-Piece	AYOTPS	AYOTPB



HINGE ROTATING PANEL  
IN MATTE BLACK

# AYO® 10MM COMPLETE WETROOM KITS CLEAR GLASS – BRUSHED BRASS & POLISHED GOLD

For ease of ordering, we have created product codes for complete wetroom kits that cover the most popular wetroom configuration choices.

Each complete kit below includes a 10mm clear glass panel, a 15mm wall profile and a suitable stabilising bar solution.

## 10MM COMPLETE WETROOM KITS

SIZE	CODE – BRUSHED BRASS	CODE – POLISHED GOLD
450mm	AYO10MWR45-CBRB	AYO10MWR45-CPG
500mm	AYO10MWR50-CBRB	AYO10MWR50-CPG
600mm	AYO10MWR60-CBRB	AYO10MWR60-CPG
700mm	AYO10MWR70-CBRB	AYO10MWR70-CPG
760mm	AYO10MWR76-CBRB	AYO10MWR76-CPG
800mm	AYO10MWR80-CBRB	AYO10MWR80-CPG
900mm	AYO10MWR90-CBRB	AYO10MWR90-CPG
1000mm	AYO10MWR100-CBRB	AYO10MWR100-CPG
1100mm	AYO10MWR110-CBRB	AYO10MWR110-CPG
1200mm	AYO10MWR120-CBRB	AYO10MWR120-CPG
1400mm	AYO10MWR140-CBRB	AYO10MWR140-CPG

650mm Angled Stabilising Bar included with 450, 500 & 600mm COMPLETE wetroom kits.  
1200mm Straight Stabilising Bar included with COMPLETE wetroom kits over 700mm.

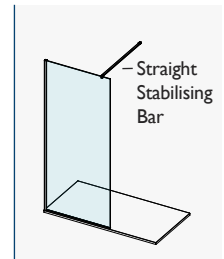
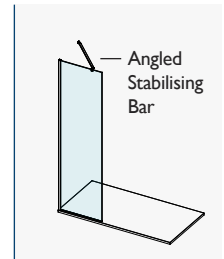

## ACCESSORIES

SIZE	CODE – BRUSHED BRASS	CODE – POLISHED GOLD
T-Piece	AYOTP-CBRB	AYOTP-CPG

For Hinge Rotating Deflector Panels - Polished Gold, please see page 151.

# AYO® 10MM COMPLETE WETROOM KITS CLEAR GLASS – POLISHED STAINLESS STEEL & MATTE NICKEL

For ease of ordering, we have created product codes for complete wetroom kits that cover the most popular wetroom configuration choices.

Each complete kit below includes a 10mm clear glass panel, a 15mm wall profile and a suitable stabilising bar solution.

## 10MM COMPLETE WETROOM KITS

SIZE	CODE – POLISHED S/STEEL	CODE – MATTE NICKEL
450mm	AYO10MWR45-SS	AYO10MWR45-CBRMN
500mm	AYO10MWR50-SS	AYO10MWR50-CBRMN
600mm	AYO10MWR60-SS	AYO10MWR60-CBRMN
700mm	AYO10MWR70-SS	AYO10MWR70-CBRMN
760mm	AYO10MWR76-SS	AYO10MWR76-CBRMN
800mm	AYO10MWR80-SS	AYO10MWR80-CBRMN
900mm	AYO10MWR90-SS	AYO10MWR90-CBRMN
1000mm	AYO10MWR100-SS	AYO10MWR100-CBRMN
1100mm	AYO10MWR110-SS	AYO10MWR110-CBRMN
1200mm	AYO10MWR120-SS	AYO10MWR120-CBRMN
1400mm	AYO10MWR140-SS	AYO10MWR140-CBRMN

650mm Angled Stabilising Bar included with 450, 500 & 600mm COMPLETE wetroom kits. 1200mm Straight Stabilising Bar included with COMPLETE wetroom kits over 700mm.

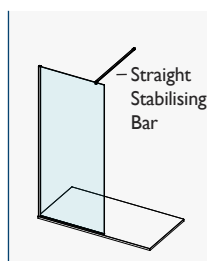
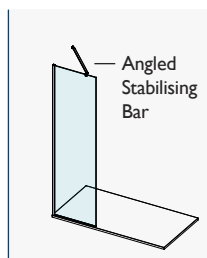

## ACCESSORIES

SIZE	CODE – POLISHED S/STEEL	CODE – MATTE NICKEL
T-Piece	AYOTPS	AYOTP-CBRMN

For Hinge Rotating Deflector Panels - Polished Stainless Steel please see page 151.

# AYO® 10MM COMPLETE WETROOM KITS CLEAR GLASS – BRUSHED NICKEL & COUNTRY BRONZE

For ease of ordering, we have created product codes for complete wetroom kits that cover the most popular wetroom configuration choices.

Each complete kit below includes a 10mm clear glass panel, a 15mm wall profile and a suitable stabilising bar solution.

## 10MM COMPLETE WETROOM KITS

SIZE	CODE – BRUSHED NICKEL	CODE – COUNTRY BRONZE
450mm	AYO10MWR45-CBRN	AYO10MWR45-CCTRYBRZ
500mm	AYO10MWR50-CBRN	AYO10MWR50-CCTRYBRZ
600mm	AYO10MWR60-CBRN	AYO10MWR60-CCTRYBRZ
700mm	AYO10MWR70-CBRN	AYO10MWR70-CCTRYBRZ
760mm	AYO10MWR76-CBRN	AYO10MWR76-CCTRYBRZ
800mm	AYO10MWR80-CBRN	AYO10MWR80-CCTRYBRZ
900mm	AYO10MWR90-CBRN	AYO10MWR90-CCTRYBRZ
1000mm	AYO10MWR100-CBRN	AYO10MWR100-CCTRYBRZ
1100mm	AYO10MWR110-CBRN	AYO10MWR110-CCTRYBRZ
1200mm	AYO10MWR120-CBRN	AYO10MWR120-CCTRYBRZ
1400mm	AYO10MWR140-CBRN	AYO10MWR140-CCTRYBRZ

650mm Angled Stabilising Bar included with 450, 500 & 600mm COMPLETE wetroom kits. 1200mm Straight Stabilising Bar included with COMPLETE wetroom kits over 700mm.

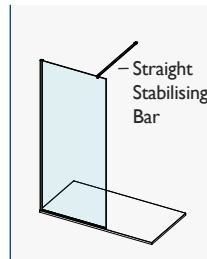
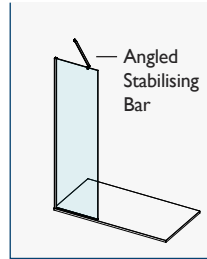

## ACCESSORIES

SIZE	CODE – BRUSHED NICKEL	CODE – COUNTRY BRONZE
T-Piece	AYOTP-CBRN	AYOTP-CCTRYBRZ

For Hinge Rotating Deflector Panels -  
Brushed Nickel & Country Bronze, please see opposite page.

# AYO® 10MM HINGE DEFELECTOR PANELS CLEAR GLASS

## 10MM HINGE ROTATING DEFLECTOR PANELS

SIZE	CODE – SILVER	CODE – BLACK
300mm	AYO10HRP30SSC	AYO10HRP30BC
450mm	AYO10HRP45SSC	AYO10HRP45BC
500mm	AYO10HRP50SSC	AYO10HRP50BC

## 10MM HINGE ROTATING DEFLECTOR PANELS

SIZE	CODE – BRUSHED BRASS	CODE – POLISHED GOLD
300mm	AYO10HRP30CBRBC	AYO10HRP30CPGC
450mm	AYO10HRP45CBRBC	AYO10HRP45CPGC
500mm	AYO10HRP50CBRBC	AYO10HRP50CPGC

## 10MM HINGE ROTATING DEFLECTOR PANELS

SIZE	CODE – POLISHED S/STEEL	CODE – MATTE NICKEL
300mm	AYO10HRP30SSC	AYO10HRP30CBRMNC
450mm	AYO10HRP45SSC	AYO10HRP45CBRMNC
500mm	AYO10HRP50SSC	AYO10HRP50CBRMNC

## 10MM HINGE ROTATING DEFLECTOR PANELS

SIZE	CODE – BRUSHED NICKEL	CODE – COUNTRY BRONZE
300mm	AYO10HRP30CBRNC	AYO10HRP30CCTRYBRZC
450mm	AYO10HRP45CBRNC	AYO10HRP45CCTRYBRZC
500mm	AYO10HRP50CBRNC	AYO10HRP50CCTRYBRZC

## 10MM ROTATING PANELS\*

SIZE	CODE – SILVER	CODE – BLACK
300mm	AYO10RP30SC	AYO10RP30BC
450mm	AYO10RP45SC	AYO10RP45BC
500mm	AYO10RP50SC	AYO10RP50BC

\*Rotating Panels can be retrofitted.

# AYO® 8MM COMPLETE WETROOM KITS CLEAR GLASS – SILVER & BLACK

For ease of ordering, we have created product codes for complete wetroom kits that cover the most popular wetroom configuration choices.

Each complete kit below includes an 8mm clear glass panel, a 15mm wall profile and a suitable stabilising bar solution.

**For 8mm Modular Wetroom Order Process, please go to page 192.**

## 8MM COMPLETE WETROOM KITS

SIZE	CODE – SILVER	CODE – BLACK
300mm	AYO8MWR30SC	AYO8MWR30BC
400mm	AYO8MWR40SC	AYO8MWR40BC
450mm	AYO8MWR45SC	AYO8MWR45BC
500mm	AYO8MWR50SC	AYO8MWR50BC
600mm	AYO8MWR60SC	AYO8MWR60BC
700mm	AYO8MWR70SC	AYO8MWR70BC
760mm	AYO8MWR76SC	AYO8MWR76BC
800mm	AYO8MWR80SC	AYO8MWR80BC
900mm	AYO8MWR90SC	AYO8MWR90BC
1000mm	AYO8MWR100SC	AYO8MWR100BC
1100mm	AYO8MWR110SC	AYO8MWR110BC
1200mm	AYO8MWR120SC	AYO8MWR120BC
1400mm	AYO8MWR140SC	AYO8MWR140BC
1500mm	AYO8MWR150SC	AYO8MWR150BC
1600mm	AYO8MWR160SC	AYO8MWR160BC
<b>Double Entry Wetroom 1200mm – Complete Package</b> (Includes 2 1200mm Straight Stabilising Bars) AYO8MWRD120SC   AYO8MWRD120BC		

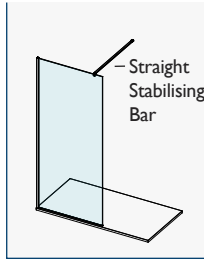
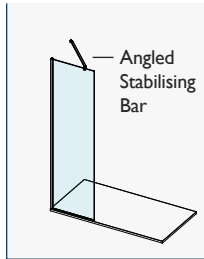

350mm Angled Stabilising Bar included with 300 & 400mm COMPLETE wetroom kits.  
 650mm Angled Stabilising Bar included with 450, 500 & 600mm COMPLETE wetroom kits.  
 1200mm Straight Stabilising Bar included with COMPLETE wetroom kits over 700mm.

## 8MM COMPLETE WETROOM SIDE PANEL KITS\*

SIZE	CODE – SILVER	CODE – BLACK
700mm	AYO8MWR70TSC	AYO8MWR70TBC
760mm	AYO8MWR76TSC	AYO8MWR76TBC
800mm	AYO8MWR80TSC	AYO8MWR80TBC
900mm	AYO8MWR90TSC	AYO8MWR90TBC
1000mm	AYO8MWR100TSC	AYO8MWR100TBC



\*1200mm Straight stabilising bar and T Piece included with COMPLETE wetroom side panel kits



# AYO® 8MM COMPLETE WETROOM KITS CLEAR GLASS – BRUSHED BRASS & MATTE NICKEL

For ease of ordering, we have created product codes for complete wetroom kits that cover the most popular wetroom configuration choices.

Each complete kit below includes a 8mm clear glass panel, a 15mm wall profile and a suitable stabilising bar solution.

8MM COMPLETE WETROOM KITS		
SIZE	CODE – BRUSHED BRASS	CODE – MATTE NICKEL
450mm	AYO8MWR45-CBRB	–
500mm	AYO8MWR50-CBRB	–
600mm	AYO8MWR60-CBRB	–
700mm	AYO8MWR70-CBRB	AYO8MWR70-CBRMN
760mm	AYO8MWR76-CBRB	–
800mm	AYO8MWR80-CBRB	AYO8MWR80-CBRMN
900mm	AYO8MWR90-CBRB	AYO8MWR90-CBRMN
1000mm	AYO8MWR100-CBRB	AYO8MWR100-CBRMN
1100mm	AYO8MWR110-CBRB	AYO8MWR110-CBRMN
1200mm	AYO8MWR120-CBRB	AYO8MWR120-CBRMN
1400mm	AYO8MWR140-CBRB	AYO8MWR140-CBRMN
1500mm	AYO8MWR150-CBRB	–
1600mm	AYO8MWR160-CBRB	–

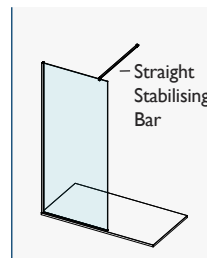
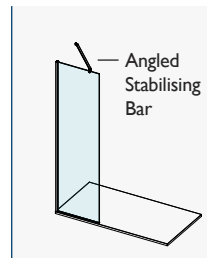

650mm Angled Stabilising Bar included with 450, 500 & 600mm COMPLETE wetroom kits.  
1200mm Straight Stabilising Bar included with COMPLETE wetroom kits over 700mm.

ACCESSORIES		
SIZE	CODE – BRUSHED BRASS	CODE – MATTE NICKEL
T-Piece	AYOTP-CBRB	AYOTP-CBRMN

# AYO® 8MM COMPLETE WETROOM KITS CLEAR GLASS – BRUSHED NICKEL & COUNTRY BRONZE

For ease of ordering, we have created product codes for complete wetroom kits that cover the most popular wetroom configuration choices.

Each complete kit below includes a 8mm clear glass panel, a 15mm wall profile and a suitable stabilising bar solution.

## 8MM COMPLETE WETROOM KITS

SIZE	CODE – BRUSHED NICKEL	CODE – COUNTRY BRONZE
700mm	AYO8MWR70-CBRN	AYO8MWR70-CCTRYBRZ
800mm	AYO8MWR80-CBRN	AYO8MWR80-CCTRYBRZ
900mm	AYO8MWR90-CBRN	AYO8MWR90-CCTRYBRZ
1000mm	AYO8MWR100-CBRN	AYO8MWR100-CCTRYBRZ
1100mm	AYO8MWR110-CBRN	AYO8MWR110-CCTRYBRZ
1200mm	AYO8MWR120-CBRN	AYO8MWR120-CCTRYBRZ
1400mm	AYO8MWR140-CBRN	AYO8MWR140-CCTRYBRZ
1400mm	–	AYO8MWR150-CCTRYBRZ
1400mm	–	AYO8MWR160-CCTRYBRZ

650mm Angled Stabilising Bar included with 450, 500 & 600mm COMPLETE wetroom kits. 1200mm Straight Stabilising Bar included with COMPLETE wetroom kits over 700mm.

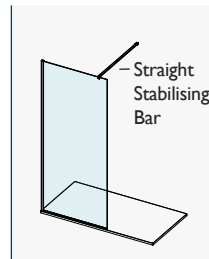
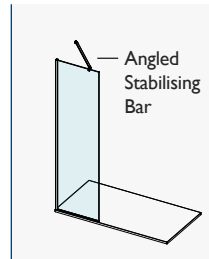

## ACCESSORIES

SIZE	CODE – BRUSHED NICKEL	CODE – COUNTRY BRONZE
T-Piece	AYOTP-CBRN	AYOTP-CCTRYBRZ



8MM COMPLETE



AYO PRODUCT ORDERING INFORMATION

AYO WETROOM COUNTRY BRONZE

# AYO® 8MM COMPLETE WETROOM KITS CLEAR GLASS – WHITE

For ease of ordering, we have created product codes for complete wetroom kits that cover the most popular wetroom configuration choices.

Each complete kit below includes a 8mm clear glass panel, a 15mm wall profile and a suitable stabilising bar solution.

## 8MM COMPLETE WETROOM KITS

SIZE	CODE – WHITE
700mm	AYO8MWR70WC
800mm	AYO8MWR80WC
900mm	AYO8MWR90WC
1000mm	AYO8MWR100WC
1100mm	AYO8MWR110WC
1200mm	AYO8MWR120WC
1400mm	AYO8MWR140WC

## 8MM ROTATING PANEL

SIZE	CODE – WHITE
300mm	AYO8RP30WC
450mm	AYO8RP45WC

## ACCESSORIES

SIZE	CODE – WHITE
T-Piece	AYOTPW

## NEW ANODISED – 8MM HANDED HINGE DEFLECTOR PANEL

PRODUCT DESCRIPTION	CODE – SILVER	CODE – BLACK/CLEAR GLASS
	300mm Right Hand	AYO8HRPR30SC
450mm Right Hand	AYO8HRPR45SC	AYO8HRPR45BC
500mm Right Hand	AYO8HRPR50SC	AYO8HRPR50BC
300mm Left Hand	AYO8HRPL30SC	AYO8HRPL30BC
450mm Left Hand	AYO8HRPL45SC	AYO8HRPL45BC
500mm Left Hand	AYO8HRPL50SC	AYO8HRPL50BC



NEW ANODISED  
FINISH  
(RIGHT-HANDED AND  
LEFT HANDED ONLY)

# AYO® 8MM HINGE DEFLECTOR PANELS - CLEAR GLASS

## 8MM HINGE ROTATING DEFLECTOR PANELS

SIZE	CODE - SILVER	CODE - BLACK
300mm	AYO8HRP30SSC	AYO8HRP30BC
450mm	AYO8HRP45SSC	AYO8HRP45BC
500mm	AYO8HRP50SSC	AYO8HRP50BC

## 8MM HINGE ROTATING DEFLECTOR PANELS

SIZE	CODE - BRUSHED BRASS	CODE - POLISHED GOLD
300mm	AYO8HRP30CBRBC	AYO8HRP30CPGC
450mm	AYO8HRP45CBRBC	AYO8HRP45CPGC
500mm	AYO8HRP50CBRBC	AYO8HRP50CPGC

## 8MM HINGE ROTATING DEFLECTOR PANELS

SIZE	CODE - POLISHED S/STEEL	CODE - MATTE NICKEL
300mm	AYO8HRP30SSC	AYO8HRP30CBRMNC
450mm	AYO8HRP45SSC	AYO8HRP45CBRMNC
500mm	AYO8HRP50SSC	AYO8HRP50CBRMNC

## 8MM HINGE ROTATING DEFLECTOR PANELS

SIZE	CODE - BRUSHED NICKEL	CODE - COUNTRY BRONZE
300mm	AYO8HRP30CBRNC	AYO8HRP30CCTRYBRZ
450mm	AYO8HRP45CBRNC	AYO8HRP45CCTRYBRZ
500mm	AYO8HRP50CBRNC	AYO8HRP50CCTRYBRZ

## 8MM ROTATING PANELS\*

SIZE	CODE - SILVER	CODE - BLACK
300mm	AYO8RP30SC	AYO8RP30BC
450mm	AYO8RP45SC	AYO8RP45BC
500mm	AYO8RP50SC	AYO8RP50BC

\*Rotating Panels can be retrofitted.

# AYO® 8MM FLUTED GLASS COMPLETE KITS

For ease of ordering, we have created product codes for complete wetroom kits that cover the most popular wetroom configuration choices.

Each complete kit below includes a 8mm fluted glass panel, a 15mm wall profile and a suitable stabilising bar solution.

## 8MM COMPLETE WETROOM KITS - FLUTED GLASS - SILVER & MATTE BLACK

SIZE	CODE - SILVER	CODE - BLACK
700mm	AYO8MWR70SFC	AYO8MWR70BFC
800mm	AYO8MWR80SFC	AYO8MWR80BFC
900mm	AYO8MWR90SFC	AYO8MWR90BFC
1000mm	AYO8MWR100SFC	AYO8MWR100BFC
1200mm	AYO8MWR120SFC	AYO8MWR120BFC
1400mm	AYO8MWR140SFC	AYO8MWR140BFC

### 8MM HINGE ROTATING DEFLECTOR PANELS - FLUTED GLASS

SIZE	CODE - SILVER	CODE - BLACK
300mm	AYO8HRP30SFC	AYO8HRP30BFC

## 8MM COMPLETE WETROOM KITS - FLUTED GLASS - BRUSHED BRASS & POLISHED GOLD

SIZE	CODE - BRUSHED BRASS	CODE - POLISHED GOLD
700mm	AYO8MWR70F-CBRB	AYO8MWR70F-CPG
800mm	AYO8MWR80F-CBRB	AYO8MWR80F-CPG
900mm	AYO8MWR90F-CBRB	AYO8MWR90F-CPG
1000mm	AYO8MWR100F-CBRB	AYO8MWR100F-CPG
1200mm	AYO8MWR120F-CBRB	AYO8MWR120F-CPG
1400mm	AYO8MWR140F-CBRB	AYO8MWR140F-CPG

### 8MM HINGE ROTATING DEFLECTOR PANELS - FLUTED GLASS

SIZE	CODE - BRUSHED BRASS	CODE - POLISHED GOLD
300mm	AYO8HRP30BBFC	AYO8HRP30PGFC

## 8MM COMPLETE WETROOM KITS - FLUTED GLASS - MATTE NICKEL

SIZE	CODE - MATTE NICKEL
700mm	AYO8MWR70F-CBRMN
800mm	AYO8MWR80F-CBRMN
900mm	AYO8MWR90F-CBRMN
1000mm	AYO8MWR100F-CBRMN
1200mm	AYO8MWR120F-CBRMN
1400mm	AYO8MWR140F-CBRMN

### 8MM HINGE ROTATING DEFLECTOR PANELS - FLUTED GLASS

SIZE	CODE - MATTE NICKEL
300mm	AYO8HRP30BRMNF



**8MM COMPLETE WETROOM KITS - FLUTED GLASS - BRUSHED NICKEL AND COUNTRY BRONZE**

SIZE	CODE - BRUSHED NICKEL	CODE - COUNTRY BRONZE
700mm	AYO8MWR70F-CBRN	AYO8MWR70F-CCTRYBRZ
800mm	AYO8MWR80F-CBRN	AYO8MWR80F-CCTRYBRZ
900mm	AYO8MWR90F-CBRN	AYO8MWR90F-CCTRYBRZ
1000mm	AYO8MWR100F-CBRN	AYO8MWR100F-CCTRYBRZ
1200mm	AYO8MWR120F-CBRN	AYO8MWR120F-CCTRYBRZ
1400mm	AYO8MWR140F-CBRN	AYO8MWR140F-CCTRYBRZ

**8MM HINGE ROTATING DEFLECTOR PANELS - FLUTED GLASS**

SIZE	CODE - BRUSHED NICKEL	CODE - COUNTRY BRONZE
300mm	AYO8HRP30BRNFC	AYO8HRP30CCTRYBRZFC

## AYO® 8MM OPAQUE GLASS COMPLETE KITS – SILVER & BLACK

Complete kit includes an 8mm opaque glass panel, 15mm wall profile and a suitable stabilising bar solution.

**8MM COMPLETE WETROOM KITS - OPAQUE GLASS (PRIVACY GLASS)**

SIZE	CODE - SILVER	CODE - BLACK
800mm	AYO8MWR80SPC	AYO8MWR80BPC
900mm	AYO8MWR90SPC	AYO8MWR90BPC
1000mm	AYO8MWR100SPC	AYO8MWR100BPC
1200mm	AYO8MWR120SPC	AYO8MWR120BPC
1400mm	AYO8MWR140SPC	AYO8MWR140BPC



8MM OPAQUE GLASS WETROOM

# THE AYO® 8MM FRAMED COLLECTION

**MATTE BLACK ONLY**  
AVAILABLE IN CLEAR GLASS & FLUTED GLASS

---

The contemporary industrial aesthetic inspired by factories and warehouses is now an established trend in bathroom design. With this in mind, the AYO Framed collection is carefully curated to deliver a striking look in the showering zone.

Standing at impressive 2 metres tall, each AYO Framed screen is coated with a Hydrophobic coating to repel against unwanted grime and limescale.

Silk screen print technology enables the interior of all AYO framed screens to retain a flush finish for ease of cleaning and maintenance. Each 8mm toughened glass panel is firstly **silk screen printed** with the black framed design applied to the glass exterior. **Black anodised metal profiles** are then bonded to the exterior of the glass panels.

Expertly designed each AYO glass panel is fully surrounded by a robust metal frame, providing maximum durability for the hardworking bathroom environment.

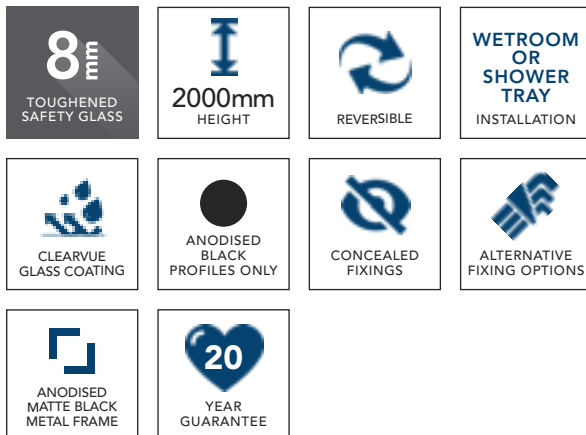





FRAMED WETROOM IN FLUTED GLASS  
CONFIGURATION 5

# AYO® 8MM FRAMED COMPLETE WETROOM KITS FLUTED GLASS – MATTE BLACK

Comes complete with 8mm Framed Wetroom Panel (fluted glass) with 15mm Wall profile & 1200mm Straight Stabilising Bar.

## AYO 8MM FRAMED WETROOM PANEL COLLECTION COMPLETE PACKAGES - FLUTED GLASS

PRODUCT DESCRIPTION

CODE - BLACK

700mm - Complete Package	AYO8MWRFB70TBFC
800mm - Complete Package	AYO8MWRFB80TBFC
900mm - Complete Package	AYO8MWRFB90TBFC
1000mm - Complete Package	AYO8MWRFB100TBFC



AYO 8MM FRAMED COMPLETE WETROOM KITS FLUTED GLASS – MATTE BLACK

# AYO® 8MM FRAMED COMPLETE WETROOM KITS CLEAR GLASS – MATTE BLACK

Comes complete with 8mm Framed Wetroom Panel (clear glass) with 15mm Wall profile & 1200mm Straight Stabilising Bar.

## AYO 8MM FRAMED WETROOM PANEL COLLECTION - COMPLETE PACKAGES

PRODUCT DESCRIPTION	CODE - BLACK
700mm - Complete Package	AYO8MWRFB70BC
760mm - Complete Package	AYO8MWRFB76BC
800mm - Complete Package	AYO8MWRFB80BC
900mm - Complete Package	AYO8MWRFB90BC
1000mm - Complete Package	AYO8MWRFB100BC
1100mm - Complete Package	AYO8MWRFB110BC
1200mm - Complete Package	AYO8MWRFB120BC
1400mm - Complete Package	AYO8MWRFB140BC

## AYO 8MM FRAMED WETROOM SIDE PANEL COLLECTION - COMPLETE PACKAGES (WITH T-PIECE)

PRODUCT DESCRIPTION	CODE - BLACK
700mm - Complete Package	AYO8MWRFB70TBC
760mm - Complete Package	AYO8MWRFB76TBC
800mm - Complete Package	AYO8MWRFB80TBC
900mm - Complete Package	AYO8MWRFB90TBC
1000mm - Complete Package	AYO8MWRFB100TBC

## AYO 8MM FRAMED WETROOM - ROTATING DEFLECTOR PANEL

SIZE	CODE - BLACK
300mm	AYO8RPF30BC
450mm	AYO8RPF45BC

## AYO 8MM LINEAR WETROOM PANEL COLLECTION - COMPLETE PACKAGES

PRODUCT DESCRIPTION	CODE - BLACK
700mm - Complete Package	AYO8MWRFB70BC
760mm - Complete Package	AYO8MWRFB76BC
800mm - Complete Package	AYO8MWRFB80BC
900mm - Complete Package	AYO8MWRFB90BC
1000mm - Complete Package	AYO8MWRFB100BC
1100mm - Complete Package	AYO8MWRFB110BC
1200mm - Complete Package	AYO8MWRFB120BC
1400mm - Complete Package	AYO8MWRFB140BC

## AYO 8MM LINEAR FRAMED WETROOM - ROTATING DEFLECTOR PANEL

SIZE	CODE - BLACK
300mm	AYO8RPFHB30BC
450mm	AYO8RPFHB45BC

## AYO 8MM LINEAR WETROOM SIDE PANEL COLLECTION - COMPLETE PACKAGES (WITH T-PIECE)

PRODUCT DESCRIPTION	CODE - BLACK
700mm - Complete Package	AYO8MWRFB70TBC
760mm - Complete Package	AYO8MWRFB76TBC
800mm - Complete Package	AYO8MWRFB80TBC
900mm - Complete Package	AYO8MWRFB90TBC
1000mm - Complete Package	AYO8MWRFB100TBC

## ACCESSORIES - BLACK

PRODUCT DESCRIPTION	CODE - BLACK
1200mm Straight Stabilising Bar	AYOSSBB
1400mm Straight Stabilising Bar	AYO140SSBB
L Shape Stabilising Bar - Length 1410mm / Height 220mm	AYOLSSBB
Top of Glass to Ceiling Bar - 600mm	AYOCSBB
Two Piece Floor to Ceiling Stabilising Bar	AYOF2CSBB



LINEAR FRAMED WETROOM  
WITH ROTATING DEFLECTOR  
PANEL - MATTE BLACK

LINEAR FRAMED CORNER  
WALK IN WETROOM



FRAMED CORNER  
WALK IN WETROOM -  
FLUTED GLASS





# FRAMED CORNER WALK-IN WETROOM

Make a visual statement by choosing a sleek and stylish AYO Framed Corner Walk-in Wetroom.

The black anodised metal profiles fully surround each glass panel and ensure maximum durability in the busy bathroom environment. These AYO Framed fixed glass panels form a luxurious wetroom arrangement that minimises water spray into the bathroom. Easy to clean, each glass panel retains its flush interior finish and has the added bonus of a hydrophobic coating that repels unwanted grime and limescale.

Choose from two striking design options - The Framed Wetroom or Linear Framed Wetroom style.

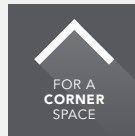

## FRAMED WETROOM

## LINEAR FRAMED WETROOM

METAL FRAMEWORK SURROUNDS GLASS, ENSURING MAXIMUM DURABILITY

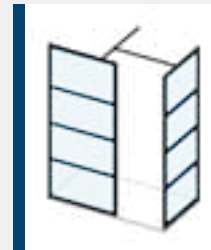
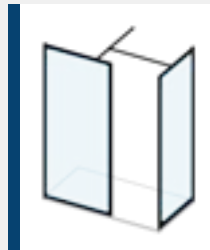

CONFIGURATION 20

CONFIGURATION 20

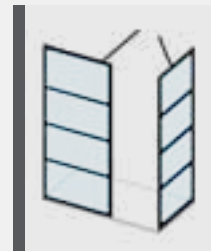
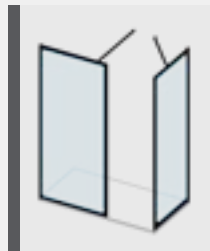

CONFIGURATION 23

CONFIGURATION 23



FRAMED CORNER WALK IN WETROOM - CLEAR GLASS

# FRAMED ROTATING DEFLECTOR PANEL

Transform your daily routine with the new AYO wetroom rotating panels available in two striking finishes, AYO Framed and AYO Linear framed matte black.

Crafted with elegance and modern aesthetics in mind. The 180-degree rotation mechanism is designed for smooth and silent operation, adding a touch of convenience and luxury to your daily routine while enhancing the overall visual appeal of your bathroom.



LINEAR FRAMED WETROOM WITH ROTATING DEFLECTOR PANEL - MATTE BLACK

## AYO 8MM LINEAR FRAMED WETROOM - ROTATING DEFLECTOR PANELS

SIZE	CODE - BLACK
300mm	AYO8RPFHB30BC
450mm	AYO8RPFHB45BC

## AYO 8MM FRAMED WETROOM - ROTATING DEFLECTOR PANEL

SIZE	CODE - BLACK
300mm	AYO8RPF30BC
450mm	AYO8RPF45BC

<b>8mm</b> TOUGHENED SAFETY GLASS	<b>2000mm</b> HEIGHT	REVERSIBLE	WETROOM OR SHOWER TRAY INSTALLATION
CLEARVUE GLASS COATING	ANODISED BLACK PROFILES ONLY	CONCEALED FIXINGS	ALTERNATIVE FIXING OPTIONS
ANODISED MATTE BLACK METAL FRAME	<b>20</b> YEAR GUARANTEE		

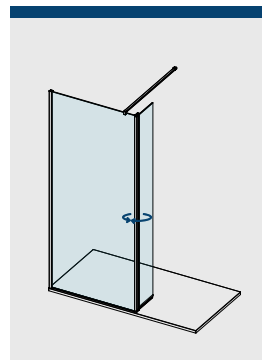

CONFIGURATION 11





FRAMED WETROOM WITH ROTATING DEFLECTOR PANEL - MATTE BLACK



AYO 8MM FRAMELESS  
BATHTHRESH WITH FLUTED GLASS -  
MATTE BLACK



---

AYO<sup>®</sup>  
BATHSCREENS

# AYO® 8MM BATHSCREENS



AYO 8MM FRAMELESS BATHSCREEN



AYO 8MM FRAMED BATHSCREEN

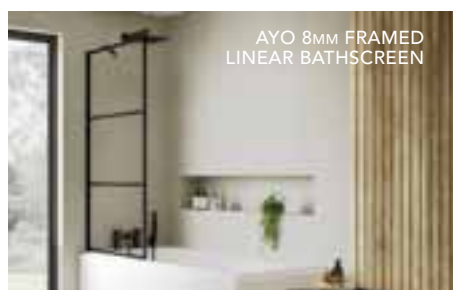

AYO 8MM FRAMED LINEAR BATHSCREEN

## AYO 8MM BATHSCREENS - CLEAR GLASS

PRODUCT DESCRIPTION	COLOUR	CODE
1500 x 800mm Bathscreen	Silver	AYO8BSSC
1500 x 800mm Bathscreen	Black	AYO8BSBC
1500 x 800mm Framed Bathscreen	Black	AYO8FBSBBC
1500 x 800mm Linear Bathscreen	Black	AYO8FHBSBBC
1500 x 800mm Bathscreen	Brushed Brass	AYO8BSBRBC



AYO 8MM FRAMELESS BATHSCREEN WITH FLUTED GLASS - BRUSHED BRASS



AYO 8MM FRAMELESS BATHSCREEN WITH FLUTED GLASS - MATTE BLACK



AYO 8MM FRAMELESS BATHSCREEN WITH FLUTED GLASS - SILVER

AYO 8MM BATHSCREENS - FLUTED GLASS

PRODUCT DESCRIPTION	COLOUR	CODE
8mm Frameless Bathscreen 800 x 1500mm - Fluted Glass Includes 15mm Wall Profile & 350mm Angled Stabilising Bar	Silver	AYO8BSFSC
8mm Frameless Bathscreen 800 x 1500mm - Fluted Glass Includes 15mm Wall Profile & 350mm Angled Stabilising Bar	Black	AYO8BSFBC
8mm Frameless Bathscreen 800 x 1500mm - Fluted Glass Includes 15mm Wall Profile & 350mm Angled Stabilising Bar	Brushed Brass	AYO8BSFBRBC
AYO 8mm Framed Border 800mm - Clear Fluted Glass	Matte Black	AYO8FBSBBFC

# VERVE PRO

## 8MM BATHSCREENS



### VERVE PRO 8MM BATHSCREENS - CLEAR GLASS

PRODUCT DESCRIPTION	COLOUR	CODE
8mm Two Panel Hinged Bathscreen (1 Fixed Panel / 1 Rotating Panel - Square Edge)	Silver	VBS13SC
8mm Two Panel Hinged Bathscreen (1 Fixed Panel / 1 Rotating Panel - Square Edge)	Black	VBS13BC
8mm Two Panel Hinged Bathscreen (1 Fixed Panel / 1 Rotating Panel - Square Edge)	Brushed Brass	VBS13BRBC





AYO WETROOM SILVER FINISH - CONFIGURATION 23





---

# AYO<sup>®</sup>

## MODULAR WETROOM

CREATE  
YOUR OWN  
CONFIGURATION

---

# DESIGN YOUR PERSONAL SHOWER SANCTUARY

Elevate your Showering experience with the flexibility and style of **AYO Modular**.

AYO Modular creates a step-by-step process that will help bring your dream shower space to life and is tailored to create a unique shower enclosure design that suits your style.

Choose from a variety of materials, colors, and finishes to create the perfect ambiance.

## AYO MODULAR WETROOMS

### STEP 1 – CHOOSE AYO GLASS PANEL(S) SIZE

**Finishes:** Clear glass, opaque glass and fluted glass options available.

See from page 186 for 10mm options and from page 192 for 8mm options.

---

### STEP 2 – CHOOSE WALL PROFILE(S) REQUIRED

**Colour:** Choose your colour option.

**Wall Profile:** Choose a 15mm wall profile (All colours) or a 35mm wall profile (Silver and Black only) or opt for a recessed wall profile (All colours).

---

### STEP 3 – CHOOSE STABILISING SOLUTION

Choose from a selection of stabilising solutions to suit your space and preference.

1200mm straight stabilising bar / 650mm angled stabilising bar available in all 7 colour finishes.

---

### STEP 4 – CHOOSE ACCESSORIES OPTIONS (IF APPLICABLE)

---

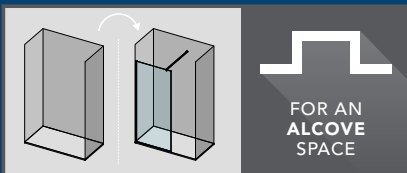
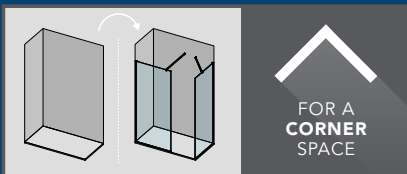
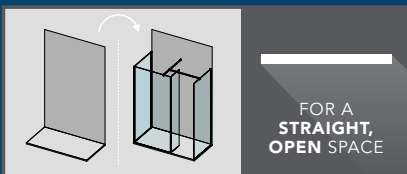

## CHOOSE & MEASURE YOUR SPACE

Please note: It is suggested to leave a minimum of 500mm wide access when measuring for your wetroom panel.

---

# CONFIGURATION GUIDE

With an almost infinite choice of wetroom configurations, AYO provides maximum flexibility as you personalise your dream shower space.

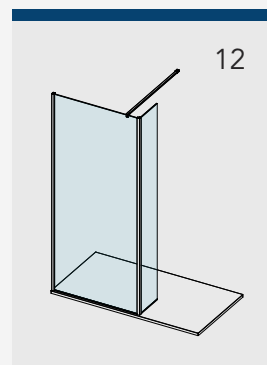
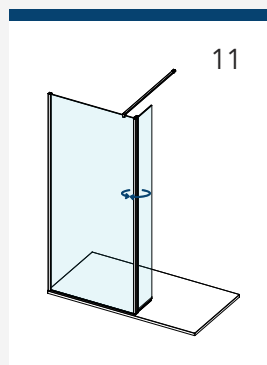
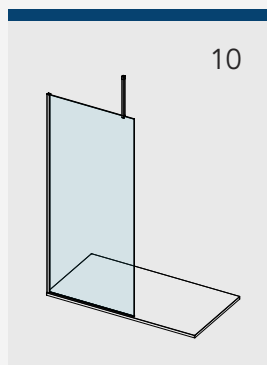
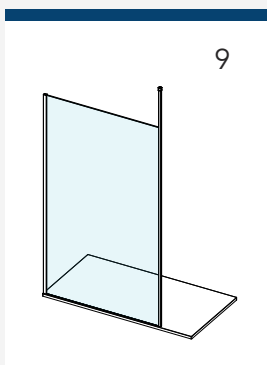
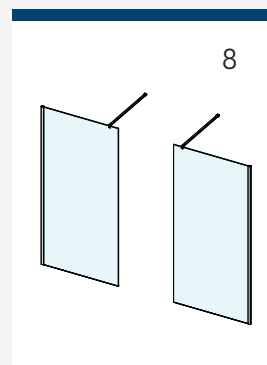
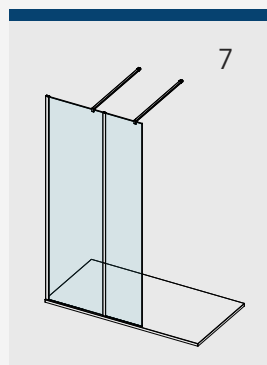
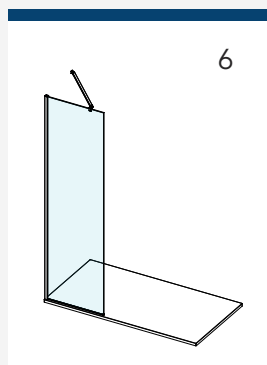
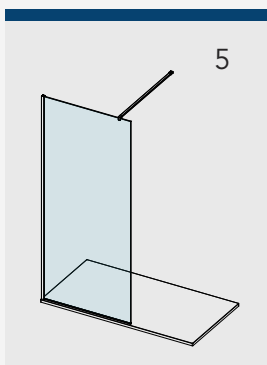
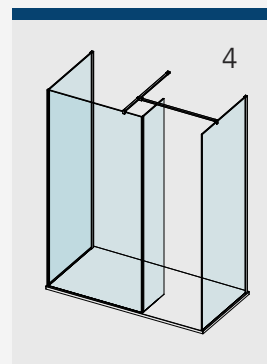
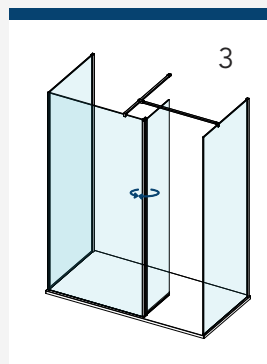
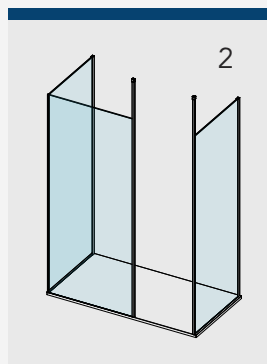
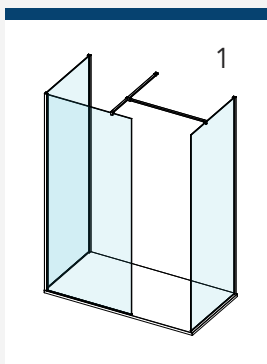

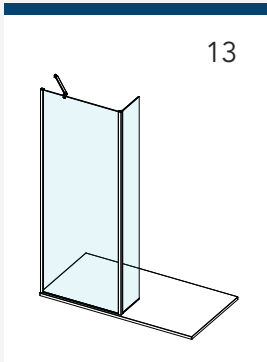

13

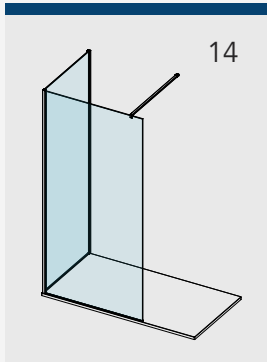

14

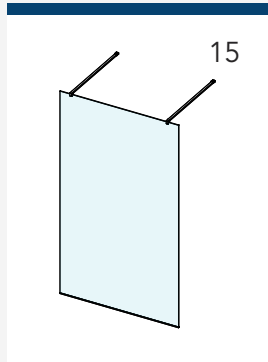

15

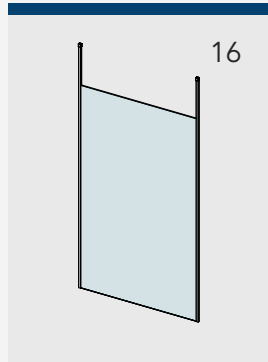

16

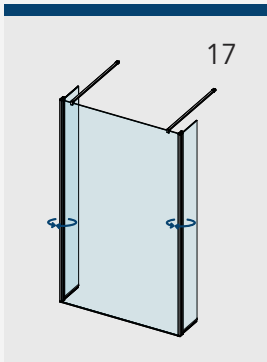

17

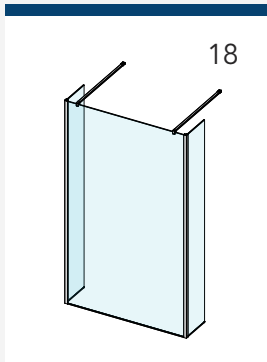

18

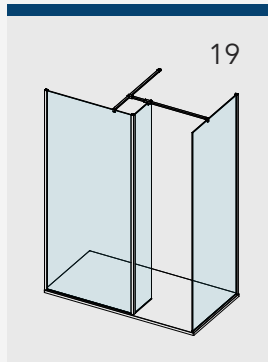

19

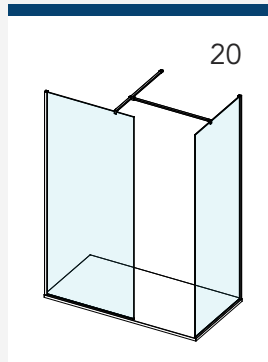

20

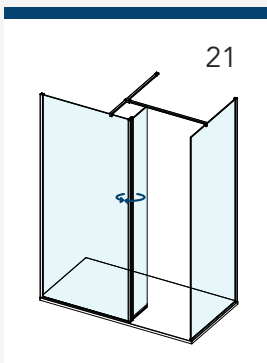

21

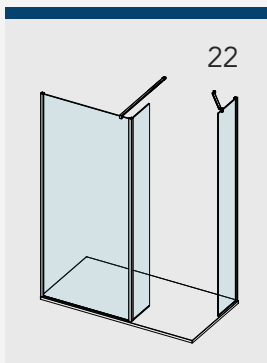

22

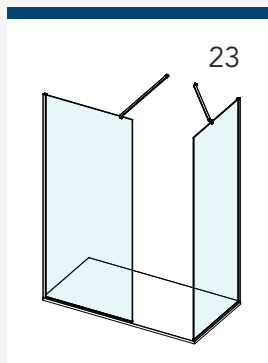

23

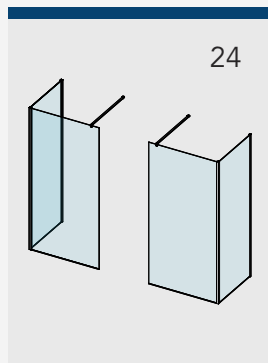

24

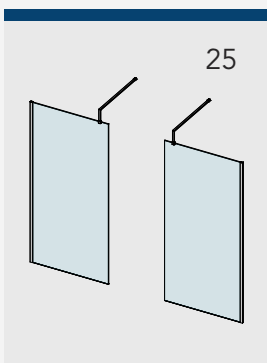

25

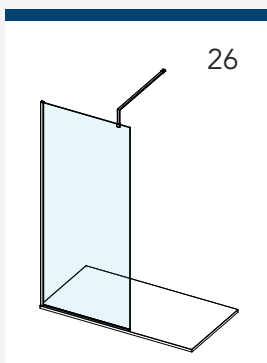

26

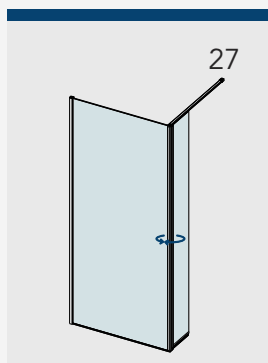

27

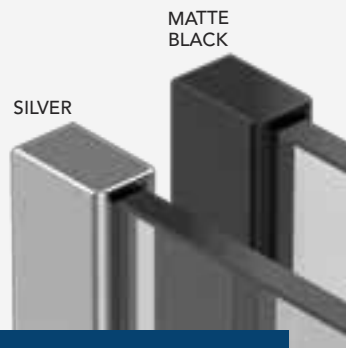

---

# PROFILE SOLUTIONS

An array of wall profile solutions provides maximum versatility as each AYO wetroom aspiration becomes the reality.

All profile solutions are available in the standard Silver and Black options.

## AYO COLOUR

Please note: 15mm Wall Profile is available the premium colours - White, Brushed Brass, Matte Nickel, Stainless Steel and Polished Gold.

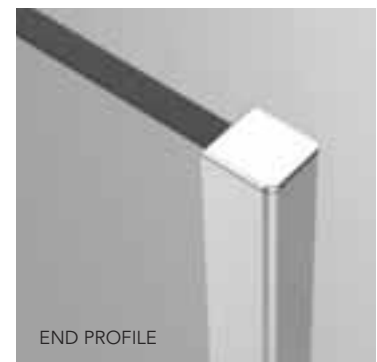
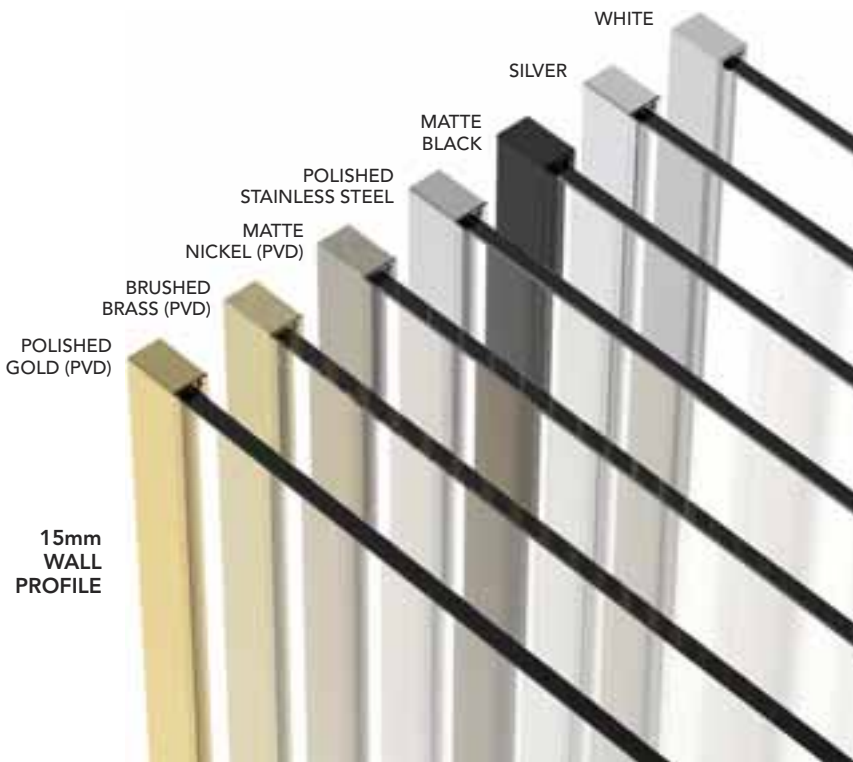
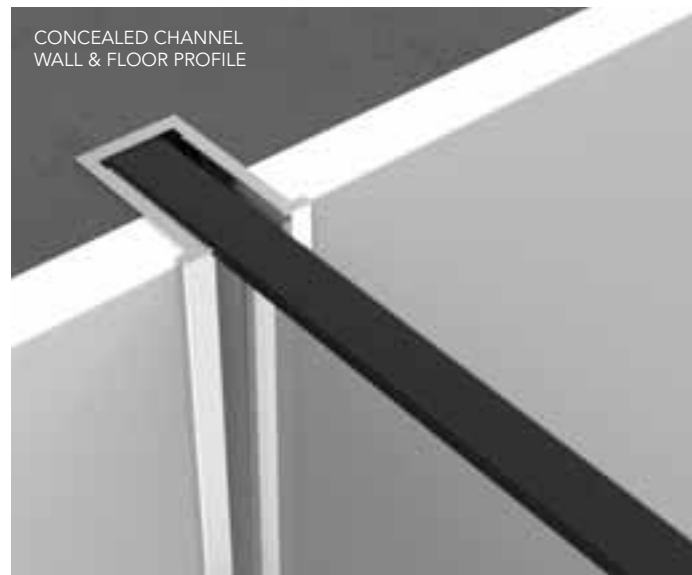

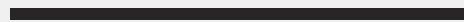

# SEAL SOLUTIONS

AYO maximizes your shower's visual appeal by offering an extensive selection of discreet ultra clear seal options.

---

# STABILISING SOLUTIONS

The subtle contours of each AYO stabilising bar delivers the perfect blend of form and function. Each fixation bracket is masterfully engineered for durability, with screw points discreetly concealed from view.

An array of stabilising solutions are available in the standard Stainless Steel and Black options.

## AYO COLOUR

Note: The following stabilising bar options are available in White Brushed Brass, Matte Nickel and Polished Gold PVD finish:

- 1200mm Straight Stabilising Bar
- 650mm Angled Stabilising Bar
- T Piece



STABILISING BAR -  
FIXING TO  
ROTATING PANEL

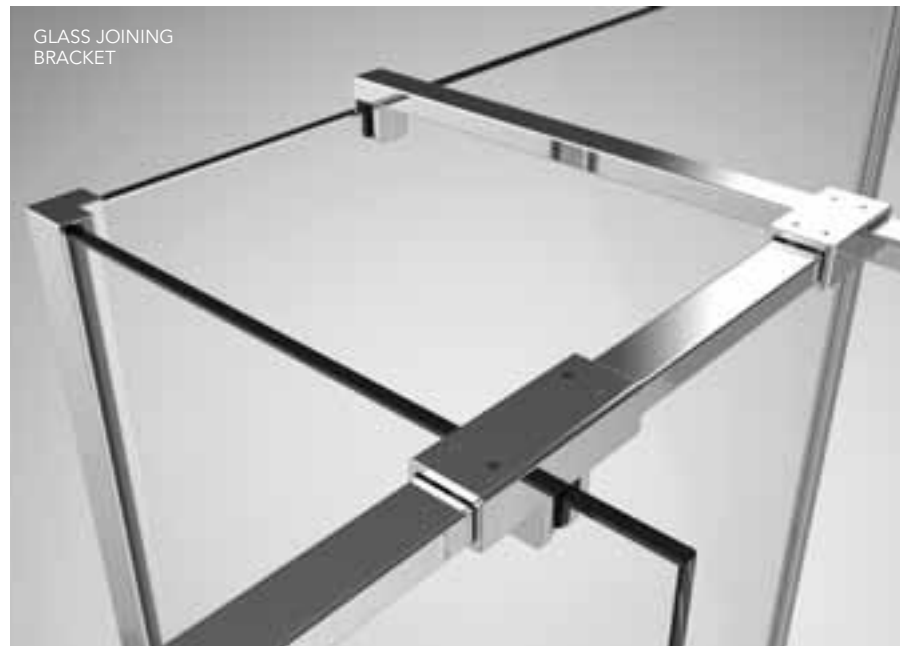

GLASS JOINING  
BRACKET



MATTE BLACK  
L-SHAPED  
STABILISING BAR



MATTE BLACK  
ANGLED STABILISING BAR





MATTE BLACK T-PIECE FITTED WITH TWO STRAIGHT STABILISING BARS



FLOOR TO CEILING STABILISING BARS



MATTE BLACK STRAIGHT STABILISING BAR



STAINLESS STEEL TOP OF GLASS TO CEILING STABILISING BAR

# AYO® 10MM MODULAR CLEAR GLASS PANEL

WETROOM PANEL 10mm GLASS / 2000mm HIGH - **SILVER & BLACK**  
 SUITABLE FOR USE ON WETROOM FLOOR OR TRAY

## MODULAR WETROOM ORDER PROCESS:

- STEP 1** – CHOOSE AYO 10MM PANEL(S) SIZE - CLEAR GLASS
- STEP 2** – CHOOSE WALL PROFILE(S) (SILVER OR BLACK)
- STEP 3** – CHOOSE STABILISING SOLUTION (SILVER OR BLACK)
- STEP 4** – CHOOSE ACCESSORIES OPTIONS (IF REQUIRED)

### STEP 1 - CHOOSE AYO 10MM PANEL(S) SIZE - CLEAR GLASS

SIZE	CODE - CLEAR GLASS
300mm	AYO10MW30C
400mm	AYO10MW40C
450mm	AYO10MW45C
500mm	AYO10MW50C
600mm	AYO10MW60C
700mm	AYO10MW70C
760mm	AYO10MW76C
800mm	AYO10MW80C
900mm	AYO10MW90C
1000mm	AYO10MW100C
1100mm	AYO10MW110C
1200mm	AYO10MW120C
1400mm	AYO10MW140C

### STEP 2 - WALL PROFILE (SILVER, BLACK OR BRUSHED BRASS)

SIZE	CODE – SILVER	CODE – BLACK	CODE – BRUSHED BRASS
15mm Wall Profile	AYOMW15WJS	AYOMW15WJB	AYOMW15WJBRB
35mm Wall Profile	AYOMW35WJS	AYOMW35WJB	–
Recessed Channel Wall & Floor Profile 2000mm	AYOMWCWJS	AYOMWCWJB	–

15MM WALL PROFILE SILVER

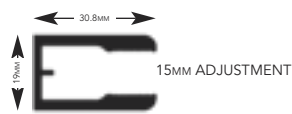

35MM WALL PROFILE SILVER

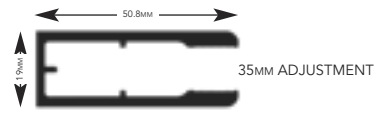

RECESSED WALL CHANNEL PROFILE



RECESSED FLOOR CHANNEL

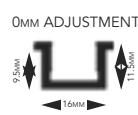

## STEP 3 - STABILISING SOLUTION (SILVER OR BLACK)

### Straight Stabilising Bar

PRODUCT DESCRIPTION	CODE - SILVER	CODE - BLACK
1200mm Straight Stabilising Bar	AYOSSBS	AYOSSBB
1400mm Straight Stabilising Bar	AYO140SSBS	AYO140SSBB

### Angled Stabilising Bar

PRODUCT DESCRIPTION	CODE - SILVER	CODE - BLACK
350mm Angled Stabilising Bar - Short for 300mm & 400mm Wetrooms	AYOASBS-SH	AYOASBB-SH
650mm Angled Stabilising Bar	AYOASBS	AYOASBB

### Ceiling Stabilising Bar

PRODUCT DESCRIPTION	CODE - SILVER	CODE - BLACK
Top of Glass to Ceiling Stabilising Bar - 600mm	AYOCSBS	AYOCSBB
Floor to Ceiling Stabilising Bar - 2600mm	AYOFCSBS	AYOFCSBB
Two Piece Floor to Ceiling Stabilising Bar - 2600mm	AYOF2CSBS	AYOF2CSBB
Two Piece Floor to Ceiling Stabilising Bar - 300mm	AYOF2CSB3S	AYOF2CSB3B

### Other Stabilising Bars

PRODUCT DESCRIPTION	CODE - SILVER	CODE - BLACK
L Shape Stabilising Bar - Length 1410mm / Height 220mm	AYOLSSBS	AYOLSSBB
Rotating Panel Stabilising Bar - 1200mm	AYORPSBS	AYORPSBB
1200mm Double Glass Bracket Stabilising Bar	AYODGBSBS	AYODGBSBB
1200mm Cuttable Stabilising Bar with Angle & Straight Bracket	AYOCASSBS	AYOCASSBB

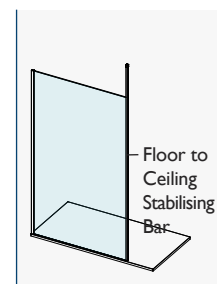
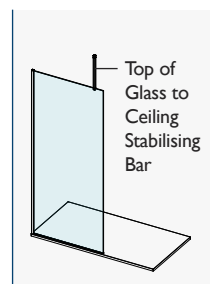
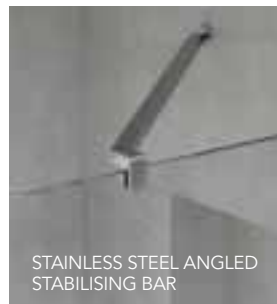

## STEP 4 – CHOOSE ACCESSORIES

### Seals - 2000mm Height

PRODUCT DESCRIPTION	CODE - SILVER	CODE - BLACK
10mm Black Corner Seal	–	AYO10CSB
10mm Ultra Clear Corner Seal	AYO10CSC	–
10mm Ultra Clear H Joining Seal	AYO10JSC	–

### Profiles - 2000mm Height

PRODUCT DESCRIPTION	CODE - SILVER	CODE - BLACK
Corner Profile - 2000mm	AYOCPS	AYOCPB
H-Joining Profile - 2000mm	AYOHJPS	AYOHJPB
End Profile - 2000mm	AYOEPS	AYOEPB

## STEP 4 – CHOOSE ACCESSORIES

PRODUCT DESCRIPTION	CODE - SILVER	CODE - BLACK
Glass Joining Bracket	AYOGJBS	AYOGJBB
T-Piece	AYOTPS	AYOTPB
10mm U Channel - 1000mm	AYO10UC1000S	AYO10UC1000B
10mm U Channel - 2000mm	AYO10UCS	AYO10UCB
Fixed Leg Support	AYOFSLS	AYOFSLB



## 10MM ROTATING PANELS\*

SIZE	CODE - SILVER	CODE - BLACK
300mm	AYO I0RP30SC	AYO I0RP30BC
450mm	AYO I0RP45SC	AYO I0RP45BC
500mm	AYO I0RP50SC	AYO I0RP50BC

\*Rotating Panels can be retrofitted.

## 10MM HINGE ROTATING DEFLECTOR PANEL

SIZE	CODE - SILVER	CODE - BLACK
300mm	AYO I0HRP30SSC	AYO I0HRP30BC
450mm	AYO I0HRP45SSC	AYO I0HRP45BC
500mm	AYO I0HRP50SSC	AYO I0HRP50BC



HINGE ROTATING PANEL  
IN MATTE BLACK

# AYO® 10MM MODULAR CLEAR GLASS PANEL

AYO 10MM GLASS 2000MM HIGH - WHITE

## MODULAR WETROOM ORDER PROCESS:

**STEP 1** – CHOOSE AYO 10MM CLEAR GLASS PANEL SIZE

**STEP 2** – CHOOSE WALL PROFILE & STABILISING KIT

**STEP 3** – CHOOSE ACCESSORIES OPTIONS (IF REQUIRED)

### STEP 1 - CHOOSE AYO 10MM PANEL SIZE - CLEAR GLASS

SIZE	CODE - CLEAR GLASS
300mm	AYO10MW30C
400mm	AYO10MW40C
450mm	AYO10MW45C
500mm	AYO10MW50C
600mm	AYO10MW60C
700mm	AYO10MW70C
760mm	AYO10MW76C
800mm	AYO10MW80C
900mm	AYO10MW90C
1000mm	AYO10MW100C
1100mm	AYO10MW110C
1200mm	AYO10MW120C
1400mm	AYO10MW140C

### STEP 2 - WALL PROFILE & STABILISING BAR KITS

15mm Wall Profile with Stabilising Bar

PRODUCT DESCRIPTION

CODE - WHITE

15mm Wall Profile & Straight Stabilising Bar Kit AYOMW15WJ-SSBW

15mm Wall Profile & Angled Stabilising Bar Kit AYOMW15WJ-ASBW

### STEP 3 – CHOOSE ACCESSORIES

PRODUCT DESCRIPTION

CODE - WHITE

Stainless Steel T-Piece - White AYOTPW

10mm Corner Super Clear Seal AYO10CSC

10mm Ultra Clear H Joining Seal AYO10JSC

### 10MM ROTATING PANEL

SIZE

CODE - WHITE

300mm AYO10RP30WC

450mm AYO10RP45WC



AYO WHITE WETROOM & ROTATING RETURN PANEL

# AYO® 8MM MODULAR CLEAR, OPAQUE & FLUTED GLASS

WETROOM PANEL 8mm GLASS / 2000mm HIGH  
SUITABLE FOR USE ON WETROOM FLOOR OR TRAY

## MODULAR WETROOM ORDER PROCESS:

- STEP 1** – CHOOSE AYO 8MM PANEL(S) SIZE - CLEAR GLASS, OPAQUE GLASS OR FLUTED GLASS
- STEP 2** – CHOOSE WALL PROFILE(S) (SILVER OR BLACK)
- STEP 3** – CHOOSE STABILISING SOLUTION REQUIRED (SILVER OR BLACK)
- STEP 4** – CHOOSE ACCESSORIES OPTIONS (IF REQUIRED)

### STEP 1 – CHOOSE AYO 8MM PANEL SIZE CLEAR GLASS, OPAQUE GLASS OR FLUTED GLASS OPTIONS

SIZE	CODE - CLEAR GLASS	CODE - OPAQUE	CODE - FLUTED
300mm	AYO8MW30C	–	AYO8MW30FC
400mm	AYO8MW40C	–	–
450mm	AYO8MW45C	–	–
500mm	AYO8MW50C	–	–
600mm	AYO8MW60C	–	–
700mm	AYO8MW70C	–	AYO8MW70FC
760mm	AYO8MW76C	–	–
800mm	AYO8MW80C	AYO8MW80PC	AYO8MW80FC
900mm	AYO8MW90C	AYO8MW90PC	AYO8MW90FC
1000mm	AYO8MW100C	AYO8MW100PC	AYO8MW100FC
1100mm	AYO8MW110C	–	–
1200mm	AYO8MW120C	AYO8MW120PC	AYO8MW120FC
1400mm	AYO8MW140C	AYO8MW140PC	AYO8MW140FC
1500mm	AYO8MW150C	–	–
1600mm	AYO8MW160C	–	–

### STEP 2 – WALL PROFILE (SILVER & BLACK)

PRODUCT DESCRIPTION	CODE - SILVER	CODE - BLACK
15mm Wall Profile	AYOMW15WJS	AYOMW15WJB
35mm Wall Profile	AYOMW35WJS	AYOMW35WJB
Recessed Channel Wall and Floor Profile 2000mm	AYOMWCWJS	AYOMWCWJB





15MM WALL PROFILE SILVER



35MM WALL PROFILE SILVER



RECESSED WALL CHANNEL PROFILE



RECESSED FLOOR CHANNEL

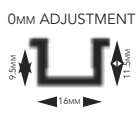

**STEP 3 - STABILISER - SILVER & BLACK**

**Straight Stabilising Bar**

PRODUCT DESCRIPTION	CODE - SILVER	CODE - BLACK
1200mm Straight Stabilising Bar	AYOSSBS	AYOSSBB
1400mm Straight Stabilising Bar	AYO140SSBS	AYO140SSBB

**Angled Stabilising Bar**

PRODUCT DESCRIPTION	CODE - SILVER	CODE - BLACK
350mm Angled Stabilising Bar - Short for 300mm & 400mm Wetrooms	AYOASBS-SH	AYOASBB-SH
650mm Angled Stabilising Bar	AYOASBS	AYOASBB

**Ceiling Stabilising Bar**

PRODUCT DESCRIPTION	CODE - SILVER	CODE - BLACK
Top of Glass to Ceiling Stabilising Bar - 600mm	AYOCSBS	AYOCSBB
Floor to Ceiling Stabilising Bar - 2600mm	AYOFCSBS	AYOFCSBB
Two Piece Floor to Ceiling Stabilising Bar - 2600mm	AYOF2CSBS	AYOF2CSBB
Two Piece Floor to Ceiling Stabilising Bar - 300mm	AYOF2CSB3S	AYOF2CSB3B

**Other Stabilising Bars**

PRODUCT DESCRIPTION	CODE - SILVER	CODE - BLACK
L Shape Stabilising Bar - Length 1410mm / Height 220mm	AYOLSSBS	AYOLSSBB
Rotating Panel Stabilising Bar - 1200mm	AYORPSBS	AYORPSBB
1200mm Double Glass Bracket Stabilising Bar	AYODGBSBS	AYODGBSBB
1200mm Cutable Stabilising Bar with Angle & Straight Bracket	AYOCASSBS	AYOCASSBB

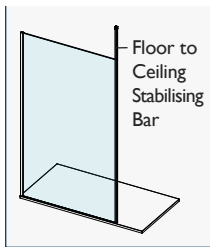
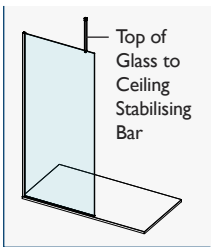

## STEP 4 – GLASS CONNECTING - SEALS & PROFILES

### Seals - 2000mm Height

PRODUCT DESCRIPTION	CODE - SILVER	CODE - BLACK
8mm Black Corner Seal	–	AYO8CSB
8mm Ultra Clear Corner Seal	AYO8CSC	–
8mm Ultra Clear Joining Seal	AYO8JSC	–

### Profiles - 2000mm Height

PRODUCT DESCRIPTION	CODE - SILVER	CODE - BLACK
Corner Profile - 2000mm	AYOCPS	AYOCPB
H-Joining Profile - 2000mm	AYOHJPS	AYOHJPB
End Profile - 2000mm	AYOEPS	AYOEPB



## ACCESSORIES

PRODUCT DESCRIPTION	CODE - SILVER	CODE - BLACK
Glass Joining Bracket	AYOGJBS	AYOGJBB
T-Piece	AYOTPS	AYOTPB
8mm U Channel - 1000mm	AYO8UC1000S	AYO8UC1000B
8mm U Channel - 2000mm	AYO8UCS	AYO8UCB
Fixed Leg Support	AYOFSLS	AYOFSLB



## 8MM ROTATING PANELS\*

PRODUCT DESCRIPTION	CODE - SILVER	CODE - BLACK
300mm Rotating Panel	AYO8RP30SC	AYO8RP30BC
450mm Rotating Panel	AYO8RP45SC	AYO8RP45BC
500mm Rotating Panel	AYO8RP50SC	AYO8RP50BC

\*Rotating Panels can be retrofitted.

## 8MM HINGE ROTATING DEFLECTOR PANEL

PRODUCT DESCRIPTION	CODE - SILVER	CODE - BLACK
300mm	AYO8HRP30SSC	AYO8HRP30BC
450mm	AYO8HRP45SSC	AYO8HRP45BC
500mm	AYO8HRP50SSC	AYO8HRP50BC



HINGE ROTATING PANEL  
IN MATTE BLACK



AYO BRUSHED BRASS WETROOM  
& HINGE ROTATING PANEL



---

# AYO<sup>®</sup>

## MODULAR COLOUR

CREATE  
YOUR OWN  
CONFIGURATION

# AYO<sup>®</sup> MODULAR COLOUR

**STEP 1** CHOOSE YOUR 8MM OR 10MM GLASS PANEL  
SEE PAGE 192 FOR THE 10MM GLASS PANEL OPTIONS - CLEAR GLASS ONLY  
SEE PAGE 198 FOR THE 8MM GLASS PANEL OPTIONS - CLEAR GLASS, OPAQUE GLASS OR FLUTED GLASS

**STEP 2** CHOOSE YOUR AYO WETROOM COLOUR FINISH AND  
SELECT WALL PROFILE AND STABILISING OPTION REQUIRED.

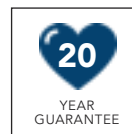

## ACCESSORIES - POLISHED STAINLESS STEEL

PRODUCT DESCRIPTION	CODE - POLISHED STAINLESS STEEL
15mm Wall Profile	AYOMW15WJS-SS
650mm Angled Stabilising Bar (To Suit Wetroom Sizes 450-650mm)	AYOASBS
1200mm Straight Stabilising Bar (Wetrooms 700mm +)	AYOSSBS
350mm Angled Stabilising Bar - Short (Wetrooms 300mm +)	AYOASBS-SH
T-Piece	AYOTPS
Recessed Wall & Floor Channel Profiles - 2 pack	AYOMWCWJS-SS
Fixed Support Leg	AYOFSL

## ACCESSORIES - BRUSHED BRASS PVD FINISH

PRODUCT DESCRIPTION	CODE - BRUSHED BRASS
15mm Brushed Brass PVD Wall Profile	AYOMW15WJSS-CBRB
650mm Angled Stabilising Bar (To Suit Wetroom Sizes 450-650mm)	AYOASB-CBRB
1200mm Straight Stabilising Bar (To Suit Wetroom Sizes 700-1600mm)	AYOSSB-CBRB
T-Piece - Brushed Brass	AYOTP-CBRB
Recessed Wall & Floor Channel Profiles - 2 pack	AYOMWCWJSS-CBRB
350mm Angled Stabilising Bar - Short (Wetrooms 300mm +)	AYOASB-SH-CBRB
15mm <b>Anodised</b> Brushed Brass Wall Profile	AYOMW15WJBRB
Ceiling Stabilising Bar - 600mm	AYOCSB-CBRB
Fixed Support Leg	AYOFSLCBRB

## ACCESSORIES - MATTE NICKEL PVD FINISH

PRODUCT DESCRIPTION	CODE - MATTE NICKEL
15mm Wall Profile	AYOMW15WJSS-CBRMN
650mm Angled Stabilising Bar (To Suit Wetroom Sizes 450-650mm)	AYOASB-CBRMN
1200mm Straight Stabilising Bar (To Suit Wetroom Sizes 700-1600mm)	AYOSSB-CBRMN
T-Piece - Matte Nickel	AYOTP-CBRMN

## ACCESSORIES - POLISHED GOLD PVD FINISH

PRODUCT DESCRIPTION	CODE - POLISHED GOLD
15mm Wall Profile	AYOMW15WJSS-CPG
650mm Angled Stabilising Bar (To Suit Wetroom Sizes 450-650mm)	AYOASB-CPG
1200mm Straight Stabilising Bar (To Suit Wetroom Sizes 700-1600mm)	AYOSSB-CPG
T-Piece - Polished Gold	AYOTP-CPG
Recessed Wall & Floor Channel Profiles - 2 pack	AYOMWCWJSS-CPG



AYO POLISHED GOLD WETROOM & HINGE ROTATING PANEL





# SHOWER TRAYS

TEXTURED SLATE, SLIMLINE,  
ANTI-SLIP & ULTRA SLIM

# SLATE TEXTURED



Gemstone Flint Grey tray with stone resin linear cover.

Gemstone White tray with square waste.



Gemstone Onyx Black tray.



# GEMSTONE



Gemstone Onyx Black tray with black square waste.



# GEMSTONE

## KEY FEATURES

- Slate texture – a natural stone resin composite with gel coat finish
- Anti slip rated – Grade 3 Rating UNE ENV 12633:2003**
- Available in 4 colours – Onyx Black, White, Graphite Black & Flint Grey
- Minimalist stainless steel waste cover in Square versions
- Stone resin linear cover standard on all linear trays
- Colour matched interior waste trap (Onyx Black, Graphite Black or Flint Grey = Grey interior waste / White tray - White interior waste)
- Supplied with 90mm McAlpine high flow waste



## GEMSTONE TRAY COLOUR OPTIONS



Note: Gemstone tray colours are reproduced as accurately as the printing process will allow. There is no guarantee of exact colour match - this brochure is a visual aid only.

For all Shower Tray Specifications see our website [www.flairshowers.com](http://www.flairshowers.com)

## WASTE DESIGN - SQUARE WASTE

25mm  
TRAY  
DEPTH



### SQUARE WASTE GRILLE OPTION

- Available in Rectangle, Square, Quadrant and Offset Quadrant shapes

## WASTE DESIGN - LINEAR WASTE

30mm  
TRAY  
DEPTH

**NEW 2023**  
STONE RESIN WASTE COVER AS  
STANDARD ON LINEAR TRAYS



- Defined gradient on linear tray
- On trend to create the minimalist wetroom look
- Rectangular shower tray shape only



## COLOUR MATCHED GRILLE OPTIONS



### COLOUR MATCHED GRILLE OPTION

- Choose to match your shower tray grille to the precise colour of your tray. Available in White, Graphite Black and Flint Grey



## GEMSTONE SLATE TRAY RANGE - SQUARE WASTE HEIGHT - 25mm

Price includes 90mm McAlpine manufactured high flow waste



### RECTANGLE

PRODUCT DESCRIPTION	COLOUR	CODE
Rectangular Tray 1000 x 800mm - Square Waste	White	GEM1008RWS
Rectangular Tray 1000 x 800mm - Square Waste	Graphite Black	GEM1008RBS
Rectangular Tray 1000 x 800mm - Square Waste	Flint Grey	GEM1008RGS
Rectangular Tray 1000 x 800mm - Square Waste	Onyx Black	GEM1008ROS
Rectangular Tray 1000 x 900mm - Square Waste	White	GEM1009RWS
Rectangular Tray 1000 x 900mm - Square Waste	Graphite Black	GEM1009RBS
Rectangular Tray 1000 x 900mm - Square Waste	Flint Grey	GEM1009RGS
Rectangular Tray 1000 x 900mm - Square Waste	Onyx Black	GEM1009ROS
Rectangular Tray 1100 x 800mm - Square Waste	White	GEM1108RWS
Rectangular Tray 1100 x 800mm - Square Waste	Graphite Black	GEM1108RBS
Rectangular Tray 1100 x 800mm - Square Waste	Flint Grey	GEM1108RGS
Rectangular Tray 1100 x 900mm - Square Waste	White	GEM1109RWS
Rectangular Tray 1100 x 900mm - Square Waste	Graphite Black	GEM1109RBS
Rectangular Tray 1100 x 900mm - Square Waste	Flint Grey	GEM1109RGS
Rectangular Tray 1200 x 800mm - Square Waste	White	GEM1208RWS
Rectangular Tray 1200 x 800mm - Square Waste	Graphite Black	GEM1208RBS
Rectangular Tray 1200 x 800mm - Square Waste	Flint Grey	GEM1208RGS
Rectangular Tray 1200 x 800mm - Square Waste	Onyx Black	GEM1208ROS
Rectangular Tray 1200 x 900mm - Square Waste	White	GEM1209RWS
Rectangular Tray 1200 x 900mm - Square Waste	Graphite Black	GEM1209RBS
Rectangular Tray 1200 x 900mm - Square Waste	Flint Grey	GEM1209RGS
Rectangular Tray 1200 x 900mm - Square Waste	Onyx Black	GEM1209ROS
Rectangular Tray 1200 x 1000mm - Square Waste	White	GEM120100RWS
Rectangular Tray 1200 x 1000mm - Square Waste	Graphite Black	GEM120100RBS
Rectangular Tray 1200 x 1000mm - Square Waste	Flint Grey	GEM120100RGS
Rectangular Tray 1200 x 1000mm - Square Waste	Onyx Black	GEM120100ROS
Rectangular Tray 1400 x 800mm - Square Waste	White	GEM1408RWS
Rectangular Tray 1400 x 800mm - Square Waste	Graphite Black	GEM1408RBS
Rectangular Tray 1400 x 800mm - Square Waste	Flint Grey	GEM1408RGS
Rectangular Tray 1400 x 800mm - Square Waste	Onyx Black	GEM1408ROS
Rectangular Tray 1400 x 900mm - Square Waste	White	GEM1409RWS
Rectangular Tray 1400 x 900mm - Square Waste	Graphite Black	GEM1409RBS
Rectangular Tray 1400 x 900mm - Square Waste	Flint Grey	GEM1409RGS
Rectangular Tray 1400 x 900mm - Square Waste	Onyx Black	GEM1409ROS
Rectangular Tray 1400 x 1000mm - Square Waste	White	GEM140100RWS
Rectangular Tray 1400 x 1000mm - Square Waste	Graphite Black	GEM140100RBS
Rectangular Tray 1400 x 1000mm - Square Waste	Flint Grey	GEM140100RGS
Rectangular Tray 1400 x 1000mm - Square Waste	Onyx Black	GEM140100ROS



## GEMSTONE TRAY RANGE - SQUARE WASTE - 25MM DEPTH

### RECTANGLE

PRODUCT DESCRIPTION	COLOUR	CODE
Rectangular Tray 1500 x 800mm - Square Waste	White	GEMI5080RWS
Rectangular Tray 1500 x 800mm - Square Waste	Graphite Black	GEMI5080RBS
Rectangular Tray 1500 x 800mm - Square Waste	Flint Grey	GEMI5080RGS
Rectangular Tray 1500 x 900mm - Square Waste	White	GEMI5090RWS
Rectangular Tray 1500 x 900mm - Square Waste	Graphite Black	GEMI5090RBS
Rectangular Tray 1500 x 900mm - Square Waste	Flint Grey	GEMI5090RGS
Rectangular Tray 1600 x 800mm - Square Waste	White	GEMI6080RWS
Rectangular Tray 1600 x 800mm - Square Waste	Graphite Black	GEMI6080RBS
Rectangular Tray 1600 x 800mm - Square Waste	Flint Grey	GEMI6080RGS
Rectangular Tray 1600 x 800mm - Square Waste	Onyx Black	GEMI6080ROS
Rectangular Tray 1600 x 900mm - Square Waste	White	GEMI6090RWS
Rectangular Tray 1600 x 900mm - Square Waste	Graphite Black	GEMI6090RBS
Rectangular Tray 1600 x 900mm - Square Waste	Flint Grey	GEMI6090RGS
Rectangular Tray 1600 x 900mm - Square Waste	Onyx Black	GEMI6090ROS
Rectangular Tray 1700 x 700mm - Square Waste	White	GEMI7070RWS
Rectangular Tray 1700 x 700mm - Square Waste	Graphite Black	GEMI7070RBS
Rectangular Tray 1700 x 700mm - Square Waste	Flint Grey	GEMI7070RGS
Rectangular Tray 1700 x 800mm - Square Waste	White	GEMI7080RWS
Rectangular Tray 1700 x 800mm - Square Waste	Graphite Black	GEMI7080RBS
Rectangular Tray 1700 x 800mm - Square Waste	Flint Grey	GEMI7080RGS
Rectangular Tray 1700 x 800mm - Square Waste	Onyx Black	GEMI7080ROS
Rectangular Tray 1700 x 900mm - Square Waste	White	GEMI7090RWS
Rectangular Tray 1700 x 900mm - Square Waste	Graphite Black	GEMI7090RBS
Rectangular Tray 1700 x 900mm - Square Waste	Flint Grey	GEMI7090RGS
Rectangular Tray 1700 x 900mm - Square Waste	Onyx Black	GEMI7090ROS
Rectangular Tray 1800 x 800mm - Square Waste	White	GEMI8080RWS
Rectangular Tray 1800 x 800mm - Square Waste	Graphite Black	GEMI8080RBS
Rectangular Tray 1800 x 800mm - Square Waste	Flint Grey	GEMI8080RGS
Rectangular Tray 1800 x 900mm - Square Waste	White	GEMI8090RWS
Rectangular Tray 1800 x 900mm - Square Waste	Graphite Black	GEMI8090RBS
Rectangular Tray 1800 x 900mm - Square Waste	Flint Grey	GEMI8090RGS

### SQUARE

PRODUCT DESCRIPTION	COLOUR	CODE
Square Tray 800mm - Square Waste	White	GEM80SWS
Square Tray 800mm - Square Waste	Graphite Black	GEM80SBS
Square Tray 800mm - Square Waste	Flint Grey	GEM80SGS
Square Tray 800mm - Square Waste	Onyx Black	GEM80SOS
Square Tray 900mm - Square Waste	White	GEM90SWS
Square Tray 900mm - Square Waste	Graphite Black	GEM90SBS
Square Tray 900mm - Square Waste	Flint Grey	GEM90SGS
Square Tray 900mm - Square Waste	Onyx Black	GEM90SOS
Square Tray 1000mm - Square Waste	White	GEM100SWS
Square Tray 1000mm - Square Waste	Graphite Black	GEM100SBS
Square Tray 1000mm - Square Waste	Flint Grey	GEM100SGS

## GEMSTONE SLATE TRAY RANGE - SQUARE WASTE HEIGHT - 25mm

Price includes 90mm McAlpine manufactured high flow waste



### QUADRANT

PRODUCT DESCRIPTION	COLOUR	CODE
Quadrant Tray 900mm - Square Waste	White	GEM90QWS
Quadrant Tray 900mm - Square Waste	Graphite Black	GEM90QBS
Quadrant Tray 900mm - Square Waste	Flint Grey	GEM90QGS
Quadrant Tray 900mm - Square Waste	Onyx Black	GEM90QOS
Quadrant Tray 1000mm - Square Waste	White	GEM100QWS
Quadrant Tray 1000mm - Square Waste	Graphite Black	GEM100QBS
Quadrant Tray 1000mm - Square Waste	Flint Grey	GEM100QGS

### OFFSET QUADRANT

PRODUCT DESCRIPTION	COLOUR	CODE
Offset Quadrant Tray 1000 x 800mm LEFT HAND - Square Waste	White	GEM10080QWSL
Offset Quadrant Tray 1000 x 800mm RIGHT HAND - Square Waste	White	GEM10080QWSR
Offset Quadrant Tray 1000 x 800mm LEFT HAND - Square Waste	Graphite Black	GEM10080QBSL
Offset Quadrant Tray 1000 x 800mm RIGHT HAND - Square Waste	Graphite Black	GEM10080QBSR
Offset Quadrant Tray 1000 x 800mm LEFT HAND - Square Waste	Flint Grey	GEM10080QGSL
Offset Quadrant Tray 1000 x 800mm RIGHT HAND - Square Waste	Flint Grey	GEM10080QGSR
Offset Quadrant Tray 1200 x 800mm LEFT HAND - Square Waste	White	GEM12080QWSL
Offset Quadrant Tray 1200 x 800mm RIGHT HAND - Square Waste	White	GEM12080QWSR
Offset Quadrant Tray 1200 x 800mm LEFT HAND - Square Waste	Graphite Black	GEM12080QBSL
Offset Quadrant Tray 1200 x 800mm RIGHT HAND - Square Waste	Graphite Black	GEM12080QBSR
Offset Quadrant Tray 1200 x 800mm LEFT HAND - Square Waste	Flint Grey	GEM12080QGSL
Offset Quadrant Tray 1200 x 800mm RIGHT HAND - Square Waste	Flint Grey	GEM12080QGSR
Offset Quadrant Tray 1200 x 800mm LEFT HAND - Square Waste	Onyx Black	GEM12080QOSL
Offset Quadrant Tray 1200 x 800mm RIGHT HAND - Square Waste	Onyx Black	GEM12080QOSR
Offset Quadrant Tray 1200 x 900mm LEFT HAND - Square Waste	White	GEM12090QWSL
Offset Quadrant Tray 1200 x 900mm RIGHT HAND - Square Waste	White	GEM12090QWSR
Offset Quadrant Tray 1200 x 900mm LEFT HAND - Square Waste	Graphite Black	GEM12090QBSL
Offset Quadrant Tray 1200 x 900mm RIGHT HAND - Square Waste	Graphite Black	GEM12090QBSR
Offset Quadrant Tray 1200 x 900mm LEFT HAND - Square Waste	Flint Grey	GEM12090QGSL
Offset Quadrant Tray 1200 x 900mm RIGHT HAND - Square Waste	Flint Grey	GEM12090QGSR
Offset Quadrant Tray 1200 x 900mm LEFT HAND - Square Waste	Onyx Black	GEM12090QOSL
Offset Quadrant Tray 1200 x 900mm RIGHT HAND - Square Waste	Onyx Black	GEM12090QOSR

## COLOUR MATCHED METAL GRILLES - SQUARE

PRODUCT DESCRIPTION	COLOUR	CODE
Square Grille	Black	GEMGSB
Square Grille	Chrome	GEMGSC
Square Grille	Grey	GEMGSG
Square Grille	White	GEMGSW
Square Grille	Onyx Black	GEMGSOB

## GEMSTONE SLATE TRAY RANGE - LINEAR WASTE HEIGHT - 30mm

Price includes 90mm McAlpine manufactured high flow waste



## NEW - RECTANGLE - NOW INCLUDES STONE RESIN LINEAR GRILLE COVER

PRODUCT DESCRIPTION	COLOUR	CODE
Rectangular Tray 1200 x 800mm - Linear Waste	Onyx Black	GEM12080ROBL
Rectangular Tray 1200 x 800mm - Linear Waste	White	GEM12080RWL
Rectangular Tray 1200 x 800mm - Linear Waste	Graphite Black	GEM12080RBL
Rectangular Tray 1200 x 800mm - Linear Waste	Flint Grey	GEM12080RGL
Rectangular Tray 1200 x 900mm - Linear Waste	White	GEM12090RWL
Rectangular Tray 1200 x 900mm - Linear Waste	Graphite Black	GEM12090RBL
Rectangular Tray 1200 x 900mm - Linear Waste	Flint Grey	GEM12090RGL
Rectangular Tray 1200 x 900mm - Linear Waste	Onyx Black	GEM12090ROBL
Rectangular Tray 1400 x 800mm - Linear Waste	White	GEM14080RWL
Rectangular Tray 1400 x 800mm - Linear Waste	Graphite Black	GEM14080RBL
Rectangular Tray 1400 x 800mm - Linear Waste	Flint Grey	GEM14080RGL
Rectangular Tray 1400 x 800mm - Linear Waste	Onyx Black	GEM14080ROBL
Rectangular Tray 1400 x 900mm - Linear Waste	White	GEM14090RWL
Rectangular Tray 1400 x 900mm - Linear Waste	Graphite Black	GEM14090RBL
Rectangular Tray 1400 x 900mm - Linear Waste	Flint Grey	GEM14090RGL
Rectangular Tray 1400 x 900mm - Linear Waste	Onyx Black	GEM14090ROBL
Rectangular Tray 1500 x 800mm - Linear Waste	White	GEM15080RWL
Rectangular Tray 1500 x 800mm - Linear Waste	Graphite Black	GEM15080RBL
Rectangular Tray 1500 x 800mm - Linear Waste	Flint Grey	GEM15080RGL
Rectangular Tray 1500 x 900mm - Linear Waste	White	GEM15090RWL
Rectangular Tray 1500 x 900mm - Linear Waste	Graphite Black	GEM15090RBL
Rectangular Tray 1500 x 900mm - Linear Waste	Flint Grey	GEM15090RGL
Rectangular Tray 1600 x 800mm - Linear Waste	White	GEM16080RWL
Rectangular Tray 1600 x 800mm - Linear Waste	Graphite Black	GEM16080RBL
Rectangular Tray 1600 x 800mm - Linear Waste	Flint Grey	GEM16080RGL
Rectangular Tray 1600 x 900mm - Linear Waste	White	GEM16090RWL
Rectangular Tray 1600 x 900mm - Linear Waste	Graphite Black	GEM16090RBL
Rectangular Tray 1600 x 900mm - Linear Waste	Flint Grey	GEM16090RGL

## GEMSTONE SLATE TRAY RANGE - LINEAR WASTE HEIGHT - 30mm

Price includes 90mm McAlpine manufactured high flow waste



ONYX BLACK TRAY  
WITH STONE RESIN  
LINEAR GRILLE COVER

### RECTANGLE - NOW INCLUDES STONE RESIN LINEAR GRILLE COVER

PRODUCT DESCRIPTION	COLOUR	CODE
Rectangular Tray 1700 x 700mm - Linear Waste	White	GEM17070RWL
Rectangular Tray 1700 x 700mm - Linear Waste	Graphite Black	GEM17070RBL
Rectangular Tray 1700 x 700mm - Linear Waste	Flint Grey	GEM17070RGL
Rectangular Tray 1700 x 700mm - Linear Waste	Onyx Black	GEM17070ROBL
Rectangular Tray 1700 x 800mm - Linear Waste	White	GEM17080RWL
Rectangular Tray 1700 x 800mm - Linear Waste	Graphite Black	GEM17080RBL
Rectangular Tray 1700 x 800mm - Linear Waste	Flint Grey	GEM17080RGL
Rectangular Tray 1700 x 800mm - Linear Waste	Onyx Black	GEM17080ROBL
Rectangular Tray 1700 x 900mm - Linear Waste	White	GEM17090RWL
Rectangular Tray 1700 x 900mm - Linear Waste	Graphite Black	GEM17090RBL
Rectangular Tray 1700 x 900mm - Linear Waste	Flint Grey	GEM17090RGL
Rectangular Tray 1700 x 900mm - Linear Waste	Onyx Black	GEM17090ROBL

### COLOUR MATCHED METAL GRILLES - LINEAR (STAINLESS STEEL MATERIAL)

PRODUCT DESCRIPTION	COLOUR	CODE
70mm Grille - Linear	Black	GEMG70LB
70mm Grille - Linear	Chrome	GEMG70LC
70mm Grille - Linear	Grey	GEMG70LG
70mm Grille - Linear	White	GEMG70LW
80mm Grille - Linear	Black	GEMG80LB
80mm Grille - Linear	Chrome	GEMG80LC
80mm Grille - Linear	Grey	GEMG80LG
80mm Grille - Linear	White	GEMG80LW
90mm Grille - Linear	Black	GEMG90LB
90mm Grille - Linear	Chrome	GEMG90LC
90mm Grille - Linear	Grey	GEMG90LG
90mm Grille - Linear	White	GEMG90LW



WHITE GEMSTONE TRAY  
WITH LINEAR WASTE

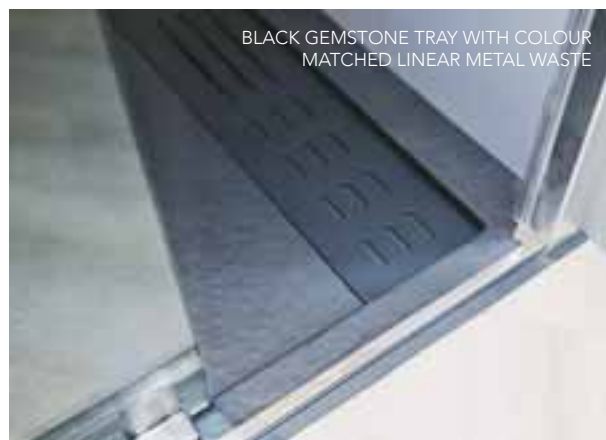

BLACK GEMSTONE TRAY WITH COLOUR  
MATCHED LINEAR METAL WASTE



## GEMSTONE INFORMATION

### GUARANTEE

Your Gemstone tray must be inspected 100% before installation. Fitting of tray is acceptance of quality. Please read fitting instructions fully before installation.

Before tiling and placing the screen or any other fixed material on the shower tray, please make sure that the perimeters of your tray are 100% level in all directions.

The guarantee only covers the replacement or repair of the product and excludes any other compensation, assembly or travel costs.

Gemstone Trays are guaranteed for 2 years, in accordance with current European regulations.

**The following are excluded from the guarantee:**

- Damage caused by misuse
- Damage caused by the use of unsuitable cleaning materials (do not use products containing acids, alcohol, chlorine or solvents, do not spill drain cleaners onto the shower tray, do not use metallic or scouring pads)
- Damage caused by improper installation
- Damage caused by the improper handling of the product

Our products must be installed by qualified personnel to be eligible for the product guarantee. An installation guide will be delivered with the tray for its proper placement.

**Before installing the tray you should make sure that:**

- The tray drains well and is 100% level
- It has no anomalies
- **The tray has been stored in a horizontal position, on a flat surface, until installation**

### CLEANING

- Routine: rinse and leave to dry
- Thorough: rub with a soft cloth with neutral liquid detergent; for limescale prevention use an anti-lime product

**Please note, Gemstone Trays are manufactured from a natural stone resin composition. You must allow for a tray thickness tolerance of 2 - 3mm.**

### CHEMICAL TESTS

Chemical resistance tested in accordance with UNE-EN 12527 - No deterioration.

### CHEMICAL TESTING COMPOSITION

Acetyl acid (10%), sodium hydroxide (10%), ethanol (70%), bleach, methylene blue (1%).

CLEANING SOLVENT (PRODUCT)	EXPOSURE TIME (DAYS)	RESULT OF VISUAL INSPECTION
Don Limpio Neutral PH	4	No Visible Effect
Perfumed Home Bleach	4	Slight Bleaching
Ace	4	Slight Bleaching
Perfumed Ammonia	4	No Visible Effect
Viakal	4	Slight Bleaching
Cillit Bang	4	No Visible Effect
KH-7 Anti-lime	4	No Visible Effect
White Wine Vinegar	4	No Visible Effect
Povidone Iodine	4	No Visible Effect
Hydrochloric Acid	4	No Visible Effect
Hydrogen Peroxide	4	No Visible Effect
Cleaning Solvent	4	No Visible Effect
Methylated Spirits	4	No Visible Effect
Acetone	4	No Visible Effect
Nail Polish Remover	4	No Visible Effect

### PACKAGING AND STORAGE

The products are delivered packed in individual boxes with expanded polystyrene reinforcements, including the drainage grate. **Gemstone trays must be stored in a horizontal position on a flat surface until installation. This prevents the tray from losing shape.**

### FAQ

#### Can it be cut?

Yes, with a diamond cutting wheel.

**Note - Maximum trim of 200mm on rectangular waste trays. Maximum trim of 100mm on linear waste trays, with the cut applied to opposite end to the linear drain.**

#### Can it be repaired?

Although they are highly resistant to any impact, we have a repair kit available to the customer. Please contact us on 01279 443 644 to order your Gemstone Tray repair kit. Lead time applies.

#### How should the product be cleaned?

We recommend cleaning with water and neutral soap, applied with a sponge, never with scouring products or tools.

#### What material should I use to install the products?

Your Gemstone tray must be installed on a fully level glue-cement or mortar base. For sealing the product, it is recommended to use MS flexible polyurethane sealant and / or a neutral silicone.

# SHOWER TRAYS

EXTENSIVE SELECTION OF SHOWER TRAY SHAPES AND SIZES TO COMPLEMENT YOUR BATHROOM.

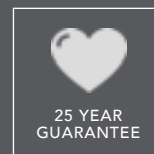

STRONG AND RIGID CONSTRUCTION

MANUFACTURED TO BRITISH STANDARD BS6340/5

TOUGH HIGH GLOSS ABS ACRYLIC CAPPED SURFACE FINISH

EASY-TO-CLEAN AND MAINTAIN



SLIMLINE RECTANGLE TRAY INCLUDING SHOWER WASTE



SLIMLINE SQUARE TRAY INCLUDING SHOWER WASTE



SLIMLINE QUADRANT TRAY INCLUDING SHOWER WASTE



SLIMLINE OFFSET QUADRANT TRAY INCLUDING SHOWER WASTE (right hand illustrated)

# SLIMLINE SHOWER TRAYS

## RECTANGLE

PRODUCT DESCRIPTION	CODE
800 x 700mm	TSL8070R
900 x 700mm	TSL9070R
900 x 760mm	TSL9076R
900 x 800mm	TSL9080R
1000 x 700mm	TSL10070R
1000 x 760mm	TSL10076R
1000 x 800mm	TSL10080R
1000 x 900mm	TSL10090R
1100 x 700mm	TSL11070R
1100 x 760mm	TSL11076R
1100 x 800mm	TSL11080R
1100 x 900mm	TSL11090R
1200 x 700mm	TSL12070R
1200 x 760mm	TSL12076R
1200 x 800mm	TSL12080R
1200 x 900mm	TSL12090R
1300 x 800mm	TSL13080R
1300 x 900mm	TSL13090R
1400 x 700mm	TSL14070R
1400 x 800mm	TSL14080R
1400 x 900mm	TSL14090R
1500 x 700mm	TSL15070R
1500 x 760mm	TSL15076R
1500 x 800mm	TSL15080R
1500 x 900mm	TSL15090R
1600 x 700mm	TSL16070R
1600 x 800mm	TSL16080R
1600 x 900mm	TSL16090R
1700 x 700mm	TSL17070R
1700 x 750mm	TSL17075R
1700 x 800mm	TSL17080R
1700 x 900mm	TSL17090R
1800 x 800mm	TSL18080R
1800 x 900mm	TSL18090R
2000 x 900mm	TSL20090R

**Note.**  
There is a tolerance of up to 10mm in tray sizes above the nominal dimensions. This is to allow for potential shrinkage during the manufacturing process.

## SQUARE

PRODUCT DESCRIPTION	CODE
700 x 700mm	TSL70S
760 x 760mm	TSL76S
800 x 800mm	TSL80S
900 x 900mm	TSL90S
1000 x 1000mm	TSL100S
1200 x 1200mm	TSL120S

## QUADRANT

PRODUCT DESCRIPTION	CODE
800 x 800mm	TSL80Q
900 x 900mm	TSL90Q
1000 x 1000mm	TSL100Q

## OFFSET QUADRANT

PRODUCT DESCRIPTION	CODE
900 x 760mm - Left	TSL9076LOQ
900 x 760mm - Right	TSL9076ROQ
900 x 800mm - Left	TSL9080LOQ
900 x 800mm - Right	TSL9080ROQ
1000 x 800mm - Left	TSL10080LOQ
1000 x 800mm - Right	TSL10080ROQ
1000 x 900mm - Left	TSL10090LOQ
1000 x 900mm - Right	TSL10090ROQ
1100 x 800mm - Left	TSL11080LOQ
1100 x 800mm - Right	TSL11080ROQ
1100 x 900mm - Left	TSL11090LOQ
1100 x 900mm - Right	TSL11090ROQ
1200 x 800mm - Left	TSL12080LOQ
1200 x 800mm - Right	TSL12080ROQ
1200 x 900mm - Left	TSL12090LOQ
1200 x 900mm - Right	TSL12090ROQ



OFFSET QUADRANT  
LEFT HAND



OFFSET QUADRANT  
RIGHT HAND

# ANTI-SLIP SHOWER TRAYS

HEIGHT 40mm (INCLUDES WASTE)

## RECTANGLE

PRODUCT DESCRIPTION	CODE
1000 x 800mm	ASTSLI0080R
1000 x 900mm	ASTSLI0090R
1100 x 800mm	ASTSLI1080R
1100 x 900mm	ASTSLI1090R
1200 x 700mm	ASTSLI2070R
1200 x 760mm	ASTSLI2076R
1200 x 800mm	ASTSLI2080R
1200 x 900mm	ASTSLI2090R
1400 x 700mm	ASTSLI4070R
1400 x 800mm	ASTSLI4080R
1400 x 900mm	ASTSLI4090R
1500 x 700mm	ASTSLI5070R
1500 x 800mm	ASTSLI5080R
1500 x 900mm	ASTSLI5090R
1600 x 700mm	ASTSLI6070R
1600 x 800mm	ASTSLI6080R
1600 x 900mm	ASTSLI6090R
1700 x 700mm	ASTSLI7070R
1700 x 800mm	ASTSLI7080R
1700 x 900mm	ASTSLI7090R

Note - There is a tolerance of up to 10mm in tray sizes above the nominal dimensions. This is to allow for potential shrinkage during the manufacturing process.

## SQUARE

PRODUCT DESCRIPTION	CODE
800mm	ASTSL80S
900mm	ASTSL90S
1000mm	ASTSL100S

## QUADRANT

PRODUCT DESCRIPTION	CODE
800mm	ASTSL80Q
900mm	ASTSL90Q
1000mm	ASTSL100Q



TEXTURED ANTI-SLIP TRAY SURFACE



## OFFSET QUADRANT

PRODUCT DESCRIPTION	CODE
Anti-Slip Slimline Offset Quadrant Tray 1000 x 800mm - <b>Left Hand</b>	ASTSL10080LOQ
Anti-Slip Slimline Offset Quadrant Tray 1000 x 800mm - <b>Right Hand</b>	ASTSL10080ROQ
Anti-Slip Slimline Offset Quadrant Tray 1000 x 900mm - <b>Left Hand</b>	ASTSL10090LOQ
Anti-Slip Slimline Offset Quadrant Tray 1000 x 900mm - <b>Right Hand</b>	ASTSL10090ROQ
Anti-Slip Slimline Offset Quadrant Tray 1200 x 800mm - <b>Left Hand</b>	ASTSL12080LOQ
Anti-Slip Slimline Offset Quadrant Tray 1200 x 800mm - <b>Right Hand</b>	ASTSL12080ROQ
Anti-Slip Slimline Offset Quadrant Tray 1200 x 900mm - <b>Left Hand</b>	ASTSL12090LOQ
Anti-Slip Slimline Offset Quadrant Tray 1200 x 900mm - <b>Right Hand</b>	ASTSL12090ROQ

## ANTI-SLIP SLIMLINE - TRAYS WITH CORNER WASTE

PRODUCT DESCRIPTION	CODE
900 x 900mm - Quadrant Tray - Inc. Corner Waste	CASTSL90Q
1000 x 1000mm Quadrant Tray - Inc. Corner Waste	CASTSL100Q
900 x 900mm - Square Tray - Inc. Corner Waste	CASTSL90S
1000 x 1000mm - Square Tray - Inc. Corner Waste	CASTSL100S
1000 x 800mm - Rectangle Tray - Inc. Corner Waste	CASTSL10080R
1200 x 800mm - Rectangle Tray - Inc. Corner Waste	CASTSL12080R
1200 x 900mm - Rectangle Tray - Inc. Corner Waste	CASTSL12090R

# ULTRA SLIM 25MM SHOWER TRAYS

HEIGHT 25mm (INCLUDING WASTE & WHITE GRILLE)

## RECTANGLE

PRODUCT DESCRIPTION	CODE
1000 x 800mm - Inc. Waste & White Grille	USLI0080R
1000 x 900mm - Inc. Waste & White Grille	USLI0090R
1200 x 800mm - Inc. Waste & White Grille	USLI2080R
1200 x 900mm - Inc. Waste & White Grille	USLI2090R
1400 x 800mm - Inc. Waste & White Grille	USLI4080R
1400 x 900mm - Inc. Waste & White Grille	USLI4090R
1500 x 800mm - Inc. Waste & White Grille	USLI5080R
1500 x 900mm - Inc. Waste & White Grille	USLI5090R
1600 x 800mm - Inc. Waste & White Grille	USLI6080R
1600 x 900mm - Inc. Waste & White Grille	USLI6090R
1700 x 800mm - Inc. Waste & White Grille	USLI7080R
1700 x 900mm - Inc. Waste & White Grille	USLI7090R
1800 x 800mm - Inc. Waste & White Grille	USLI8080R
1800 x 900mm - Inc. Waste & White Grille	USLI8090R

## SQUARE

PRODUCT DESCRIPTION	CODE
800 x 800mm - Inc. Waste & White Grille	USL80S
900 x 900mm - Inc. Waste & White Grille	USL90S

## QUADRANT

PRODUCT DESCRIPTION	CODE
800 x 800mm - Inc. Waste & White Grille	USL80Q
900 x 900mm - Inc. Waste & White Grille	USL90Q

## OFFSET QUADRANT

PRODUCT DESCRIPTION	CODE
1000 x 800mm <b>Left Hand</b> - Inc. Waste & White Grille	USLI0080LOQ
1000 x 800mm <b>Right Hand</b> - Inc. Waste & White Grille	USLI0080ROQ
1200 x 800mm <b>Left Hand</b> - Inc. Waste & White Grille	USLI2080LOQ
1200 x 800mm <b>Right Hand</b> - Inc. Waste & White Grille	USLI2080ROQ
1200 x 900mm <b>Left Hand</b> - Inc. Waste & White Grille	USLI2090LOQ
1200 x 900mm <b>Right Hand</b> - Inc. Waste & White Grille	USLI2090ROQ

# ANTI-SLIP ULTRA SLIM 25MM SHOWER TRAYS

HEIGHT 25mm (INCLUDING WASTE & WHITE GRILLE)

## RECTANGLE

PRODUCT DESCRIPTION	CODE
1000 x 800mm - Inc. Waste & White Grille	AUSLI0080R
1200 x 800mm - Inc. Waste & White Grille	AUSLI2080R
1200 x 900mm - Inc. Waste & White Grille	AUSLI2090R
1400 x 800mm - Inc. Waste & White Grille	AUSLI4080R
1400 x 900mm - Inc. Waste & White Grille	AUSLI4090R
1500 x 800mm - Inc. Waste & White Grille	AUSLI5080R
1600 x 800mm - Inc. Waste & White Grille	AUSLI6080R
1600 x 900mm - Inc. Waste & White Grille	AUSLI6090R
1700 x 800mm - Inc. Waste & White Grille	AUSLI7080R
1700 x 900mm - Inc. Waste & White Grille	AUSLI7090R

## SQUARE

PRODUCT DESCRIPTION	CODE
900 x 900mm - Inc. Waste & White Grille	AUSL90S



ULTRA SLIM RECTANGLE TRAY  
INCLUDING WASTE AND WHITE GRILLE



ULTRA SLIM SQUARE TRAY  
INCLUDING WASTE AND WHITE GRILLE



ULTRA SLIM QUADRANT TRAY  
INCLUDING WASTE AND WHITE GRILLE



ULTRA SLIM OFFSET QUADRANT TRAY (RIGHT HAND)  
INCLUDING WASTE AND WHITE GRILLE

# SHOWER ACCESSORIES

## PROSEAL WATERPROOF BARRIER SEAL

PRODUCT DESCRIPTION	CODE
ProSeal 2 metre Roll	PROS2.0M
ProSeal 2.5 metre Roll	PROS2.5M
ProSeal 3 metre Roll	PROS3.0M
ProSeal 3.5 metre Roll	PROS3.5M
ProSeal 4 metre Roll	PROS4.0M
ProSeal 10 metre Roll	PROS10.0M
ProSeal 20 metre Roll	PROS20.0M

Flexible up-stand seal installed onto shower trays, baths and

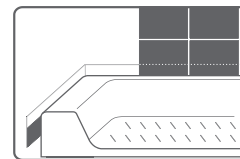
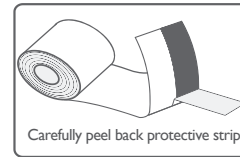

risk of water leakage.

## SHOWER WASTE

PRODUCT DESCRIPTION	CODE
TSL 90mm High Flow Waste - Chrome	TSLWASTE

## McALPINE WASTES

PRODUCT DESCRIPTION	CODE
McAlpine 90mm Shower Waste Matte Black Plastic Dome	ST90MB10-70
McAlpine 90mm Shower Waste White Plastic Dome	ST90WH10-70



McAlpine 90mm Shower Waste  
Matte Black Plastic Dome

# FLAIR EASY PLUMB KIT

Flair slimline easy plumb shower kits have adjustable legs to comply with building regulations to assist in installation and for maintenance of waste outlets if required after building settlement.

The Flair slimline easy plumb kit provides this access without compromising on style in the bathroom.

An easy plumb tray can be made by using any of the Flair slimline trays and a kit. This will increase the height of the tray by 95mm.

Accessories are not to scale - for visual representation only.



PRODUCT DESCRIPTION	WEIGHT	CODE
Easy Plumb Riser Kit for all Square Trays & Rectangle Trays (Suitable for maximum tray size of 1200mm)	2kg	WD3
Easy Plumb Riser Kit for all Quadrant Trays (Suitable for maximum tray size of 1200 x 900mm)	3kg	WD4
Easy Plumb Kit for all Square & Rectangle Trays (Up to 2000mm in size)	2kg	WD5

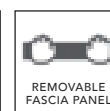
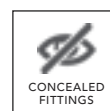
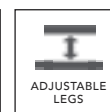
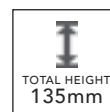

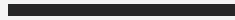

# CREATE YOUR SPACE

Scale 5mm = 100mm  
25mm x 25mm Grid = 500mm x 500mm  
175mm x 200mm Whole Grid = 3500mm x 4000mm

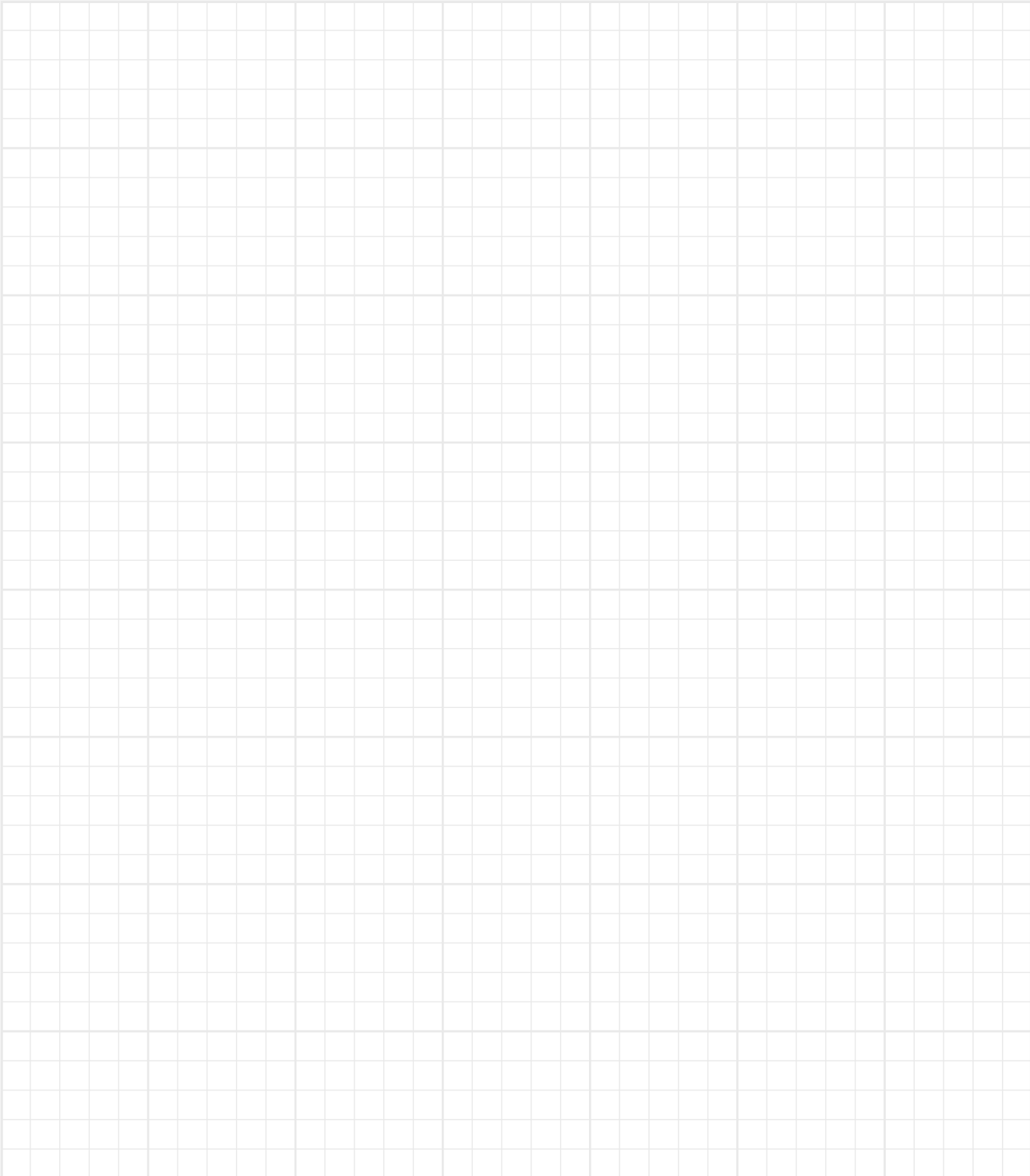

# QUALITY GUARANTEED

## At Flair we have an unwavering commitment to product quality.

All Flair Shower doors and wetrooms are CE approved and manufactured in accordance with ISO 9001:2000 Quality Assurance systems. All glass is toughed safety glass and produced to EN12150.

Flair products are performance tested to EN14428. Shower doors and rotating wetroom panels have been subject to lifetime shower door cycle testing consisting of 20,000 functional cycles.

Flair Shower doors and rotating wetroom panels have also been tested for their durability, stability, and water retention properties to ensure that they meet the highest possible industry standards. Water is maintained where conventional showering practices are used and the product has been fitted in accordance with the Flair Fitting Instructions. Please note - Due to the weight of certain products, they may require a two man lift.

Images shown in this catalogue are for illustrative purposes only. All descriptions contained in this catalogue are for the purpose of explaining each product more clearly and do not form part of any contract with the company.

### Guarantee

ORO & ETO Shower Doors are covered by a lifetime guarantee against manufacturer defect. A lifetime guarantee constitutes a term of 20 years. AYO Wetrooms and Bathscreens are covered by a 20 year guarantee against manufacturer defect. Shower Trays are subject to manufacturer guarantee. All guarantees are valid on the condition that goods are installed and maintained in accordance with the products fitting instructions and best practices. This guarantee is for domestic use only.

**\*Note: Non glass and detachable parts such as seals and cover caps are subject to normal wear and tear during usage and are under statutory guarantee for 2 years from time of purchase. Glass shattering is not subject to Lifetime guarantee.**

We ask our customers to register their guarantee online at [www.flairshowers.com](http://www.flairshowers.com) or return the guarantee card that comes with every Flair product.

### Aftersales & Spare Parts Service

Flair Showers are 100% committed to customer service excellence. For ultimate peace of mind, a comprehensive range of spare parts is available for all Flair product ranges. If you would like to talk to an aftercare specialist about your Flair product, please contact us on (Ireland & Northern Ireland) +353 42 966 8000 or (UK) 0800 1800 8050.

### Return Policy

Flair will not accept return of any product that has been opened. We do not accept return of any product if the packaging has been damaged. If the product is unopened and not damaged, we will accept the return of the product but a handling fee of 25% of the invoice price will be charged.

### Cleaning Guidelines

- Glass: Use a soft cloth and warm soapy water; rinse off thoroughly.
- Metallic Surfaces: Use a soft cloth and warm soapy water; rinse off thoroughly.
- Do not use "Spray & leave" cleaning products on the metal surface as these will cause damage to your product. These include acidic based cleaning products, bleaches, solvents or abrasive pads.
- In hard water areas, regular cleaning of your Flair door will help to prevent the build-up of limescale. Stubborn deposits of limescale can be removed with warm soapy water.
- Check your shower door for functionality periodically. Ensure that the wheel track is free from any grit / dirt which may have collected over time.

### Installation

Full installation instructions are provided with each product to ensure correct installation. All Shower doors and wetroom panels are adjustable between the dimensions stated. All dimensions are approximate.

### Shower Tray Installation

All shower trays must be installed as per instructions supplied. Install on a base of fine sand, cement and cement additive. Please note: Silicone sealants, foams, mastics, installation compound adhesive or similar must not be used as a substitute for cement. Ensure shower tray is 100% level and water test to ensure water is draining correctly. If not satisfied at any stage do not proceed with fitting. Fitting of Shower Tray is acceptance of quality.

### Conditions of Sale

Unless otherwise stated, all price quotations are subject to acceptance within 30 days of date of issue. Other than in the case of faulty goods / incorrect despatch, Flair will not accept the return of any product.

**AS PART OF OUR CONTINUING POLICY OF PRODUCT IMPROVEMENT, WE RESERVE THE RIGHT TO AMEND SPECIFICATIONS, COLOURS AND PRICES WITHOUT PRIOR NOTICE.**

\*Errors and Omissions Exempt.





BEHIND  
THE  
SCENES





WATCH  
THE  
VIDEO



# BROWSE OUR WATERFALL LOOKBOOK



FIND  
YOUR  
FLAIR





flair  
—

Flair Showers

---

Ireland / Northern Ireland  
**+353 42 966 8000**

---

England / Scotland / Wales  
**0800 180 8050**

---

[sales@flairshowers.com](mailto:sales@flairshowers.com)



[FLAIRSHOWERS.COM](http://FLAIRSHOWERS.COM)

